

DOCUMENT

Sentinel-3 User Handbook

Prepared by Sentinel-3 Team
Reference GMES-S3OP-EOPG-TN-13-0001
Issue 1.1
Revision 1
Date of Issue 13th January 2017
Status For External Use
Document Type User Handbook
Distribution Open

Source <https://sentinel.esa.int>

APPROVAL

Title Sentinel -3 User Handbook	
Issue 1	Revision 3
Author Sentinel-3 Team	Date 13/01/2017
Approved by Susanne Mecklenburg	Date 13/01/2017

CHANGE LOG

Reason for change	Issue	Revision	Date
SYN processing/products update	1	1	08/04/2016

CHANGE RECORD

Reference document for changes under ESA review: ISARD_ESA_ARGANS_SRAL_PRO_488

Issue	Revision		
Reason for change	Date	Pages	Paragraph(s)
OLCI Oa4 band is 490	3/06/2104	96	3.6.2
SYN processing/products update	5/11/2014		
Minor changes	5/1/2015		1.3.2, 1.6.2, 1.6.3, 5.3, 5.9.1
Minor Changes	29/2/2016		2, 3.5, 3.8, 4.4, 4.5, 4.8, 4.11, 5.2, 5.5, 5.8, 5.9, 5.11
SRAL L1 products update	28/04/2016		
S3 SRAL data latency corrected	02/05/2016	53	2.3
Sentinel-3 mission changes under ESA review	15/12/2016	7	1
Product types changes under ESA review	15/12/2016	61	2.3
Mission objectives minor changes under ESA review	15/12/2016	13	1.2
Geographical coverage minor changes under ESA review	15/12/2016	15	1.3.2
Data products changes under ESA review	15/12/2016	34	1.9
Overview changes under ESA review	15/12/2016	40	2.1
Heritage and future minor changes under ESA review	15/12/2016	50	2.1.4
Ice and sea-ice changes under ESA review	15/12/2016	54	2.2.3
S3-ALT document library changes under ESA review	15/12/2016	86	2.10
Minor changes	15/12/2016		1.4.1.2, 1.5-1.7, 2.1.3.3, 2.1.3.2, 2.1.2, 1.3.2, 1.2, 2.2.1, 2.2.2, 2.2.5, 2.4.1, 2.4.2, 2.6

Table of contents:

1 SENTINEL-3 MISSION 7

1.1 Overview8

1.1.1 Heritage.....9

1.1.2 Thematic Areas and Services.....9

1.1.3 Mission Summary10

1.2 Mission Objectives 12

1.3 Satellite Description 13

1.3.1 Orbit 14

1.3.2 Geographical Coverage 15

1.4 Ground Segment 15

1.4.1 Core Ground Segment 16

1.4.1.1 Payload Data Ground Segment (PDGS)..... 17

1.4.1.2 Flight Operations Segment (FOS)..... 18

1.5 Observation scenario 19

1.6 Mission status..... 20

1.7 Operation ramp-up phase..... 21

1.8 Instrumental Payload..... 22

1.8.1 OLCI Instrument Payload 22

1.8.2 SLSTR Instrument Payload..... 23

1.8.3 Altimetry Instruments Payload..... 24

1.9 Data Products 26

1.9.1 User Products Dissemination Concept 28

1.9.2 OLCI 29

1.9.3 SLSTR..... 30

1.9.4 Synergy 30

1.9.5 Altimetry 31

2 SENTINEL-3 ALTIMETRY USER GUIDE 32

2.1 Overview 32

2.1.1 Altimetry principles 34

2.1.2 Operating modes..... 35

2.1.3 Geophysical Measurements..... 36

2.1.3.1 Sea Surface Height 37

2.1.3.2 Significant Wave Height 37

2.1.3.3 Wind Speed 39

2.1.4 Heritage and Future 41

2.2 Applications..... 42

2.2.1 Oceanography 42

2.2.2 Coastal Zones 44

2.2.3 Ice and Sea-Ice..... 45

2.2.4 Inland Waters and Land..... 47

2.2.5 Climate 49

2.2.6 Geodesy and Geophysics 50

2.3 Product Types..... 51

2.3.1 Level-2 SRAL/MWR..... 52

2.3.2 Near Real-Time or Non Time Critical? 53

2.4 Processing Levels 54

2.4.1 Level-0..... 55

2.4.2 Level-1 55

2.4.3 Level-2 57

2.5 Resolutions 58

2.5.1 Sampling 59

2.5.2	Resolution Cells	60
2.6	Coverage	61
2.6.1	Orbit Characteristics.....	64
2.6.2	Revisit Time	64
2.7	Naming Conventions	67
2.8	Data Formats & Size.....	67
2.8.1	SAFE Logical Model.....	68
2.8.2	SAFE Components.....	69
2.8.3	NetCDF Format	70
2.9	Definitions	71
2.9.1	Units	71
2.9.2	Conventions	71
2.9.3	Notations.....	73
2.10	S3-ALT Document Library	74
	Sentinel-3A Product Notice - STM Level-2 Land NRT, STC and NTC.....	74
	Sentinel-3A Product Notice - STM Level-1 NRT and STC	75
	GSC Sentinel-3 PDGS Products Definition	75
	Sentinel-3 Product Data Format Specification - SRAL/MWR Level 1 and 2 Instrument Products	75
	Sentinel-3 User Handbook.....	75
	Sentinel-3 Product Data Format Specification - Product Structures	75
	Sentinel-3 Test Data Set Generation report for Level 2 SRAL/MWR IPF	75
	Sentinel-3 PDGS File Naming Convention.....	75
	Sentinel-3 SRAL/MWR Surface Topography Mission (STM) Level-2 ATBD.....	76
	Sentinels POD Product Handbook	76
	Sentinels POD Service File Format Specifications	76
3	SENTINEL-3 OLCI USER GUIDE	77
3.1	Introduction	77
3.2	Overview	77
3.2.1	Heritage.....	78
3.2.2	Geophysical Measurements.....	79
3.3	Applications.....	80
3.3.1	Maritime Monitoring.....	80
3.3.1.1	OLCI Marine	80
3.3.1.2	Net Primary Production Estimates	81
3.3.1.3	Algal Bloom and Water Quality Monitoring	82
3.3.1.4	Mesoscales Process	83
3.3.1.5	Extension to 3D Marine Biology	83
3.3.1.6	Sedimentary Processes	83
3.3.2	Land Monitoring	84
3.3.2.1	FAPAR - Fraction of Absorbed Photosynthetically Active Radiation (ECV).....	86
3.3.2.2	Leaf Area Index (LAI)(ECV).....	86
3.3.2.3	OLCI Terrestrial Chlorophyll Index (OTCI)	87
3.3.3	Atmospheric Monitoring	87
3.3.3.1	Atmospheric Composition.....	87
3.3.3.2	Illumination Condition	88
3.3.4	Climate Change Monitoring	89
3.4	Product Types.....	89
3.4.1	Introduction	89
3.4.2	Level-1b	90
3.4.3	Level-2 Land LRR and LFR.....	90
3.4.4	Level-2 Water WRR and WFR	91
3.5	Processing Levels	92
3.5.1	Level-0.....	92
3.5.2	Level-1	93

3.5.3	Level-2.....	94
3.6	Resolutions.....	95
3.6.1	Spatial Resolution.....	95
3.6.1.1	Full Resolution (FR).....	95
3.6.1.2	Reduced Resolution (RR).....	95
3.6.2	Radiometric Resolution - 21 bands in VIS/SWIR.....	96
3.7	Coverage.....	96
3.8	Naming Convention.....	98
3.9	Data Formats & Sizes.....	100
3.9.1	Level-0.....	101
3.9.2	Level-1.....	101
3.9.3	Level-2.....	102
3.10	Definitions.....	103
3.10.1	Units.....	103
3.10.2	Product Grid.....	105
3.10.3	Notations.....	105
3.11	Document Library.....	106
4	SENTINEL-3 SLSTR USER GUIDE.....	108
4.1	Introduction.....	108
4.2	Overview.....	108
4.2.1	Heritage.....	109
4.2.2	Geophysical Measurements.....	110
4.2.2.1	Sea Surface Temperature.....	110
4.2.2.2	Land Surface Temperature.....	112
4.3	Applications.....	113
4.3.1	Maritime Monitoring.....	113
4.3.1.1	Sea Surface Temperature.....	113
4.3.1.1.1	Climate.....	114
4.3.1.1.2	Numerical Modelling.....	114
4.3.1.1.3	Meso-Scales Analysis.....	114
4.3.1.2	Ice Surface Temperature.....	115
4.3.2	Land Monitoring.....	116
4.3.2.1	Land Surface Temperature.....	116
4.3.2.2	Fire Location and Fire Radiative Power.....	117
4.3.2.3	The Vegetation Index.....	118
4.3.3	Atmospheric Monitoring.....	118
4.3.4	Climate Change Monitoring.....	119
4.4	Product Types introduction.....	120
4.4.1	Level-1B.....	120
4.4.2	Level-2 WCT.....	121
4.4.3	Level-2 WST.....	122
4.4.4	Level-2 LST and FRP.....	122
4.5	Processing Levels.....	123
4.5.1	Level-0.....	123
4.5.2	Level-1.....	124
4.5.3	Level-2.....	125
4.6	Resolutions.....	125
4.6.1	Spatial.....	126
4.6.1.1	500m (VNIR/SWIR).....	126
4.6.1.2	1km TIR.....	126
4.6.2	Radiometric Resolution.....	127
4.7	Coverage.....	128
4.8	Naming Convention.....	129
4.9	Data Formats and Sizes.....	131

4.9.1	Introduction	131
4.9.2	Level-1	131
4.9.3	Level-2	132
4.10	Definitions	133
4.10.1	Units	133
4.10.2	Product Grid.....	134
4.10.3	Notations.....	134
4.11	Document Library	135
5	SENTINEL-3 SYNERGY USER GUIDE	136
5.1	Introduction	136
5.2	Overview	136
5.2.1	Heritage.....	137
5.3	Applications.....	138
5.3.1	Land Monitoring and Security	138
5.3.2	Climate Change Monitoring	140
5.4	Product Types.....	140
5.4.1	Introduction	140
5.4.2	Level-1 SYN	141
5.4.3	Level-2 SYN.....	141
5.4.4	Level-2 VGP	142
5.4.5	Level-2 VGK	143
5.4.6	Level-2 VG1 and V10.....	143
5.5	Processing Levels	144
5.5.1	Introduction	144
5.5.2	Level-1 processing.....	144
5.5.3	Level-2 and VGT-P processing	145
5.5.4	VGT-S processing	146
5.6	Resolutions	147
5.6.1	Spatial Resolution.....	147
5.6.2	Radiometric Resolution.....	147
5.7	Coverage	149
5.8	Naming Conventions	149
5.9	Data Format and Sizes	151
5.9.1	Introduction	151
5.9.2	SYN Level-1 Format	152
5.9.3	SYN Level-2 Format	152
5.10	Definitions	153
5.10.1	Units	153
5.10.2	Product Grid.....	154
5.10.3	Notations.....	155
5.11	Document Library	157

1 SENTINEL-3 MISSION



The main objective of the SENTINEL-3 mission is to measure **sea surface topography, sea and land surface temperature, and ocean and land surface colour** with high accuracy and reliability to support ocean forecasting systems, environmental monitoring and climate monitoring.

The SENTINEL-3 Mission Guide provides a high-level description of the mission objectives, satellite description and ground segment. It also covers an introduction to heritage missions, thematic areas and services, orbit characteristics and coverage, instrument payloads and data products.

The SENTINEL-3 mission will be jointly operated by ESA and EUMETSAT to deliver operational ocean and land observation services.

For mission planning information, see the [Copernicus Mission pages](#).

The categories are:

[Overview](#)

Gives a brief description of the [heritage](#) missions (ERS, ENVISAT and CRYOSAT-2) as well as the main [thematic areas and services](#) (e.g. ocean, land).

[Mission Objectives](#)

Describes primary and secondary objectives of the SENTINEL-3 mission.

[Satellite Description](#)

Describes the satellite platform and the communication links, as well as the [orbit characteristics](#) and the [geographical coverage](#).

[Ground Segment](#)

Describes the Flight Operations Segment ([FOS](#)), the Payload Data Ground Segment ([PDGS](#)).

[Observation Scenario](#)

Provides an overview of the SENTINEL High Level Observation Plan (HLOP).

[Instrument Payload](#)

Describes the main instruments of the SENTINEL-3 mission: Ocean and Land Colour Instrument ([OLCI](#)), Sea and Land Surface Temperature Radiometer ([SLSTR](#)), SAR Radar Altimeter ([SRAL](#)), MicroWave Radiometer ([MWR](#)) and Precise Orbit Determination ([POD](#)) instruments.

[Data Products](#)

Defines all data products available per instrument:

[OLCI](#) data products

[SLSTR](#) data products

[Synergy](#) data products

[Altimetry](#) data products.

1.1 Overview

SENTINEL-3 is a European Earth Observation satellite mission developed to support GMES ocean, land, atmospheric, emergency, security and cryospheric applications.

The main objective of the [SENTINEL-3 mission](#) is to measure **sea surface topography**, **sea and land surface temperature**, and **ocean and land surface colour** with high accuracy and reliability to support ocean forecasting systems, environmental monitoring and climate monitoring. The mission definition is driven by the need for continuity in provision of ERS, ENVISAT and SPOT vegetation data, with improvements in instrument performance and coverage.

The SENTINEL-3 mission will be **jointly operated by ESA and EUMETSAT** to deliver operational ocean and land observation services.

The spacecraft carries four **main instruments**:

- [OLCI](#): Ocean and Land Colour Instrument
- [SLSTR](#): Sea and Land Surface Temperature Instrument
- [SRAL](#): SAR Radar Altimeter
- [MWR](#): Microwave Radiometer

These are complemented by three instruments for Precise Orbit Determination ([POD](#))

- a) DORIS: a Doppler Orbit Radio positioning system
- b) GNSS: a GPS receiver, providing precise orbit determination and tracking multiple satellites simultaneously
- c) LRR: to accurately locate the satellite in orbit using a Laser Retro-Reflector system

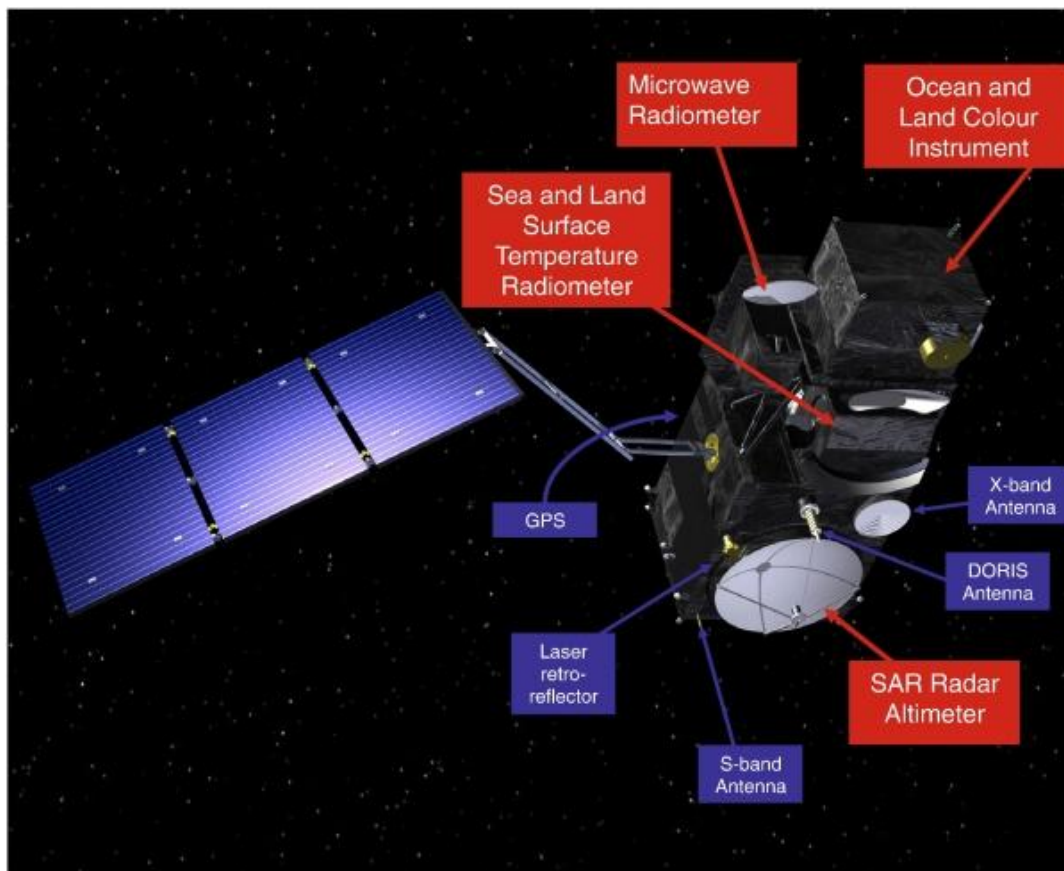

Figure 1-1: SENTINEL-3 Satellite and Payloads (Credit: ESA)

1.1.1 Heritage

SENTINEL-3 builds directly on the proven heritage of [ERS-1](#), [ERS-2](#) and [ENVISAT](#). Its innovative instrument package includes:

- A **Sea and Land Surface Temperature Radiometer** ([SLSTR](#)) based on ENVISAT's Advanced Along Track Scanning Radiometer (AATSR), to determine global sea surface temperatures to an accuracy of better than 0.3 K. The SLSTR improves the along track scanning dual-view technique of AATSR and provides advanced atmospheric correction. SLSTR measures in nine spectral channels and two additional bands. A 1.3 micron band aimed at cirrus detection and a 2 micron band aimed at vegetation, mineral and atmospheric corrections for very turbid waters. An SLSTR with spatial resolution in the visible and shortwave infra-red channels of 500 m and 1 km in the thermal infra-red channels.
- An **Ocean and Land Colour Instrument** ([OLCI](#)), based on ENVISAT's Medium Resolution Imaging Spectrometer (MERIS). With 21 bands, compared to 15 bands on MERIS, a design optimised to minimise sun-glint and a resolution of 300 m over all surfaces, OLCI marks a new generation of measurements over the ocean and land. The swath of OLCI and nadir SLSTR fully overlap.
- A dual-frequency (Ku and C-band) advanced **Synthetic Aperture Radar Altimeter** ([SRAL](#)) derived from ENVISAT RA-2, [CRYOSAT](#) SIRAL and JASON-2/POSEIDON-3, provides measurements at a resolution of approximately 300 m in SAR mode along track. SRAL is **supported by a MicroWave Radiometer** (MWR), derived from ENVISAT MWR for atmospheric correction and a **Precise Orbit Determination** (POD) package, including a GPS receiver (GNSS), a DORIS instrument and a Laser Retro-Reflector (LRR).

The combined topography package provides exact measurements of sea surface height, essential for ocean forecasting systems and climate monitoring. SRAL also provides accurate topography measurements over sea-ice, ice sheets, rivers and lakes.

1.1.2 Thematic Areas and Services

The core services of the SENTINEL-3 mission are:

Numerical Ocean Prediction

Forecasting atmospheric and oceanic conditions. More accurate forecasting helps protect people from the impacts of extreme weather events such as hurricane winds, storm surges and flooding.

Maritime Safety and Security

Monitoring ocean conditions for security and safety such as pollution (as a consequence of shipping accidents), passenger vessel safety and potential terrorist actions.

Coastal Zone Monitoring

Observing the status and characteristics of coastal zone waters to support environmental monitoring of water quality and phenomena such as harmful algal blooms for habitat assessment and management (aquaculture, sea-defences and tourism).

Open Ocean and Ice Monitoring

Monitoring the health and state of the oceans globally, on a daily basis to increase the predictability of characteristics such as sea state, ice formation, ocean circulation and the impact of physical conditions on ocean biogeochemistry.

Atmospheric Services

To provide inputs such as sea surface temperature, surface wind speed or sea state to weather prediction models.

Global Land Monitoring Applications

Providing information about the land surface that will allow monitoring of parameters such as regional and continental-scale land cover, vegetation state, vegetation productivity and fire (location, intensity and effect). Inland rivers and lake height levels can be monitored and digital elevation models of the Earth's surface can be derived providing new information for hydrological services.

Environmental Policy and Law

Supporting international negotiations and agreements (The United Nations Kyoto Protocol, the Framework Climate Convention, the European Water, Framework Directive [RD-130], the Biodiversity Convention, the EU Marine Strategy) and providing marine, coastal and land environmental data.

Climate Change Monitoring

Providing the accurate, stable, long term and consistent quality data required to monitor and study the regulating effect that ocean processes exert on climate. Improved analysis of climatological data sets will also support and enhance operational NRT forecasting applications.

Support to European Security, Humanitarian and Emergency Services

SENTINEL-3 data are not optimised for the rapid-task requirements typical of these services (e.g. floods, forest fires, earthquakes, humanitarian aid in emergencies) but they will provide a baseline wall-to-wall mapping capability at reduced resolution (0.3 - 1 km) prior to and following emergencies to support security, humanitarian and emergency services.

1.1.3 Mission Summary



Figure 1-2: Sentinel-3 satellite

SENTINEL-3 is an ocean and land mission composed of three versatile satellites (SENTINEL-3A, SENTINEL-3B and SENTINEL-3C). The mission provides data continuity for the [ERS](#), [ENVISAT](#) and SPOT satellites.

SENTINEL-3 makes use of multiple sensing instruments to accomplish its objectives:

- **SLSTR** (Sea and Land Surface Temperature Radiometer)
- **OLCI** (Ocean and Land Colour Instrument)
- **SRAL** (SAR Altimeter)
- **DORIS** (Doppler Orbitography and Radiopositioning Integrated by Satellite)
- **MWR** (Microwave Radiometer).

SLSTR and OLCI are optical instruments that are used to provide data continuity for ENVISAT's AATSR and MERIS instruments and the swaths of the two instruments overlap, allowing for new combined applications. OLCI is a medium-resolution imaging spectrometer, using five cameras to provide a wide field of view.

SRAL, DORIS, MWR and LRR are used for topographic measurements of the ocean and inland water. The SRAL altimeter is the main topographic instrument. The MWR radiometer measures water vapour, cloud water content and thermal radiation emitted by the Earth.

The observations acquired by the mission are used in conjunction with other ocean-observing missions to contribute to the Global Ocean Observing System (GOOS) which aims to create a permanent system of ocean observation.

In July 2009, ESA conducted an airborne campaign, SEN3EXP (SENTINEL-3 Experiment) to test the land and ocean imaging applications of the SENTINEL-3 mission using three instruments:

- **AHS** (Airborne Hyperspectral System)
- **CASI-1500i** (Compact Airborne Spectrographic Imager)
- **SASI-600** (Shortwave Infrared Airborne Spectrometer).

Satellite observations were also made by ENVISAT's MERIS and AATSR instruments, which are similar to the SENTINEL-3 OLCI and SLSTR instruments, and the CHRIS instrument aboard PROBA-1.

Mission Details:

Please refer to the individual Mission details available from [the Copernicus pages](#)

Operational lifespan:

7 years (With consumables for 12).

Mission objectives:

- Measuring sea-surface topography, sea-surface height and significant wave height.
- Measuring ocean and land-surface temperature.
- Measuring ocean and land-surface colour.
- Monitoring sea and land ice topography.
- Sea-water quality and pollution monitoring.
- Inland water monitoring, including rivers and lakes.
- Aid ocean forecasts with acquired data.
- Climate monitoring and modelling.
- Land-use change monitoring.
- Forest cover mapping.
- Fire detection.
- Weather forecasting.

- Measuring Earth's thermal radiation for atmospheric applications.

Mission Orbit:

Orbit Type: sun-synchronous

Orbit Height: 814.5 km

Inclination: 98.65°

Repeat Cycle: 27 days.

Payload:

- OLCI (Ocean and Land Colour Instrument)
- SLSTR (Sea and Land Surface Temperature Radiometer)
- SRAL (Synthetic Aperture Radar Altimeter)
- MWR (Microwave Radiometer)
- DORIS (Doppler Orbitography and Radiopositioning Integrated by Satellite)
- LRR (Laser Retroreflector)
- GNSS (Global Navigation Satellite System).

Resolution and Swath Width:

- OLCI - 1 270 km
- SLSTR - 1 420 km

Launch vehicle:

- ROCKOT vehicle (SENTINEL-3A)
- VEGA rocket (SENTINEL-3B)

Satellite Operators: ESA and EUMETSAT

Satellite Contractors:

Thales Alenia Space France (TAS-F) is the prime contractor, responsible for the overall. TAS-F is also the prime contractor of OLCI and SRAL instruments.

The prime contractor of SLSTR is SELEX Galileo, with the involvement of several European companies. A major sub-contractor is Jena-Optronik, in charge of the optomechanical assembly.

EADS CASA Espacio is contracted to provide the MWR instrument.

DORIS instrument is provided by CNES under a specific ESA-CNES cooperation agreement.

Eurockot and Arianespace are contracted to launch the spacecraft.

1.2 Mission Objectives

Primary Objectives

1. SENTINEL-3 provides continuity of an ENVISAT-type ocean measurement capability with consistent quality, very high level of availability (>95%), high accuracy and reliability, and in a sustained operational manner including:

- ocean, inland sea and coastal zone colour measurements to at least the level of quality of the MERIS instrument on ENVISAT

- sea surface temperature measurements to at least the level of quality of the AATSR instrument on ENVISAT
- sea surface topography measurements to at least the level of quality of the ENVISAT altimetry system, including an along track SAR capability of CRYOSAT heritage for improved measurement quality in coastal zones and over sea-ice.

2. SENTINEL-3 provides continuity of medium resolution ENVISAT-type land measurement capability in Europe to determine land surface temperature and land surface colour.

3. SENTINEL-3 provides, in a near real-time operational and timely manner, Level-1B visible, shortwave and thermal infra-red radiances and Level-2 topography products.

4. SENTINEL-3 provides, in a near real-time operational and timely manner, a generalised suite of high level primary geophysical products such as:

- global coverage Sea Surface Height (SSH) for ocean and coastal areas
- enhanced resolution SSH products in coastal zones and sea-ice regions
- global coverage Sea Surface Temperature (SST) and sea-Ice Surface Temperature (IST)
- global coverage ocean colour and water quality products
- global coverage ocean surface wind speed measurements
- global coverage significant wave height measurement
- global coverage atmospheric aerosol consistent over land and ocean
- global coverage total column water vapour over land and ocean
- global coverage vegetation products
- global coverage land ice/snow surface temperature products
- ice products (e.g., ice surface topography, extent, concentration).

Secondary Objectives

1. SENTINEL-3 provides continuity of medium resolution SPOT satellite vegetation P-like products by providing similar products over land and ocean.

2. SENTINEL-3 provides, in an operational and timely manner, a generalised suite of high level secondary geophysical products such as:

- global coverage fire monitoring products (e.g. fire radiated power, burned area, risk maps)
- inland water (lakes and rivers) surface height data.

The SENTINEL-3 [Mission Requirements Document](#) (MRD) and the SENTINEL-3 [Mission Requirements Traceability Document](#) (MRTD) describe all mission specific requirements in detail.

1.3 Satellite Description

SENTINEL-3 is a low Earth-orbit moderate size satellite compatible with small launchers including VEGA and ROCKOT. SENTINEL-3 is designed for a 7 year operational lifetime with 120 kg of hydrazine propellant allowing up to 12 years of continuous operations, including de-orbiting at the end of mission. The satellite layout is driven by the need to provide a large face viewing cold-space for thermal control, a modular design for payload accommodation and simplified management of all on-board interfaces. The satellite mechanical configuration and its flight attitude have been optimised through intensive mission analysis studies and system trade-offs performed during the mission definition, resulting in significant improvements in comparison to ENVISAT.

The main subsystems of the satellite are:

- Electrical Power System (EPS), comprising one solar array wing providing power to the spacecraft and payload.

- Attitude and Orbit Control System (AOCS) composed of a coarse sun sensor, magnetometers, coarse rate sensors, star trackers, a GNSS receiver and control actuators including thrusters, magneto-torquers and reaction wheels.
- Satellite management unit for satellite commanding and monitoring.
- Data handling and mass memory unit for payload data handling.
- Mass memory units for the satellite and its payload.
- Satellite telecommunication subsystems including an S-band subsystem for both telecommand (TC) uplink and telemetry (TM) downlink, and a dedicated high volume X-band subsystem for mission data downlink.

The main satellite platform characteristics are:

- Gyroless, three-axis stabilised platform with three star tracker heads, four reaction wheels and magnetic off-loading.
- Geodetic pointing and yaw steering.
- Eight 1 N hydrazine thrusters for in-plane and out-plane manoeuvres.
- Real-time on-board orbit accuracy determination of 3 m based on GPS and Kalman filtering.
- Launch Mass: 1 250 kg (with maturity and system margins, and fuel).
- Stowed dimensions (mm): (H) 3 710, (W) 2 202, (L) 2 207.
- Power: 2.1 kW rotary wing with 10 m² triple junction GaAs European solar cells; Li Ion Battery Capacity: 160 Ah.
- Autonomy: position timeline and on-board sun ephemeris for greater than 2 weeks nominal autonomous operations.

Communication links:

- 64 kbps uplink, 1 Mbps downlink S-band command and control link (with ranging).
- x 280 Mbps X-band science data downlink.
- 384 Gbit solid state mass memory.

1.3.1 Orbit

The SENTINEL-3 orbit is similar to the orbit of ENVISAT allowing continuation of the ERS/ENVISAT time series.

SENTINEL-3 uses a high inclination orbit (98.65°) for optimal coverage of ice and snow parameters in high latitudes. The orbit inclination is the angular distance of the orbital plane from the equator.

The SENTINEL-3 orbit is a near-polar, sun-synchronous orbit with a descending node equatorial crossing at 10:00 h Mean Local Solar time. In a sun-synchronous orbit, the surface is always illuminated at the same sun angle.

The orbital cycle is 27 days (14+7/27 orbits per day, 385 orbits per cycle). The orbit cycle is the time taken for the satellite to pass over the same geographical point on the ground.

The two in-orbit SENTINEL-3 satellites enable a short revisit time of less than two days for OLCI and less than one day for SLSTR at the equator.

The orbit reference altitude is 814.5 km.

SENTINEL-3B orbit is identical to SENTINEL-3A orbit but flown 180° out of phase with SENTINEL-3A.

The KML data files displaying the SENTINEL-3A and SENTINEL-3B orbit ground tracks for a complete cycle with a time step of 10 seconds are available [here](#).

1.3.2 Geographical Coverage

Following ENVISAT AATSR, the SLSTR instrument is a conical scanning imaging radiometer employing the along track scanning dual view technique. SLSTR provides data continuity with respect to these previous missions but with a substantial improvement due to its **higher swaths (740 km in dual view and 1 400 km in single view)**.

The OLCI push-broom instrument swath is 1 270 km. The OLCI swath is not centred at nadir (as in the MERIS design) but is tilted 12.6° westwards to mitigate the negative impact of sun-glint contamination. Fully overlapping with SLSTR instrument swath and simultaneous acquisitions facilitates the use of OLCI and SLSTR in synergy.

The altimeter instrument (SRAL) does not have a swath like SENTINEL-3 OLCI and SLSTR instruments. Across track, it receives a single measurement of the range (no image) every time a pulse is emitted.

Data is acquired systematically based on a pre-set nominal mission scenario, as defined [in the Sentinel High Level Operations Plan \(HLOP\)](#) :

- Operations for OLCI and the visible channels of the SLSTR are based on specific solar illumination conditions (SZA < 80 deg)
- MWR acquires data over the whole orbit.
- SRAL will operate in 100% SAR mode.

Figure 1-3: SENTINEL-3 Ground Track Resolution (Credit: ESA)

1.4 Ground Segment

The ground segment is composed of the [Core Ground Segment](#), the [Collaborative Ground Segment](#) and the Copernicus contributing missions' ground segments.

The Core ground segment monitors and controls the Sentinels spacecraft ensures the measurement data acquisition, processing, archiving and dissemination to the final users. In addition, it is responsible for performing conflict-free mission planning according to a pre-defined operational scenario, and it ensures the quality of the data products and the performance of the space borne sensors by continuous monitoring, calibration and validation activities, guaranteeing the overall performance of the mission.

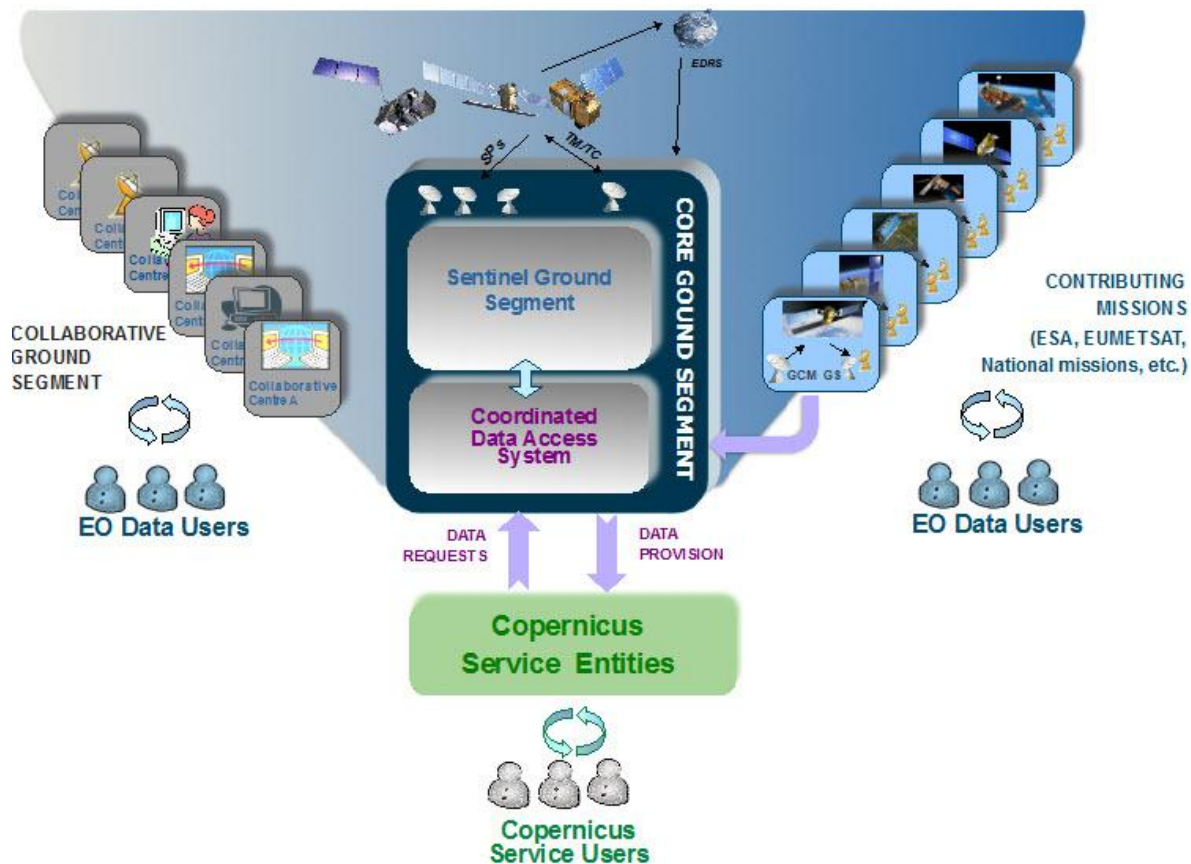

Figure 1-4: Copernicus Ground Segment Architecture

The Copernicus Ground Segment is complemented by the **Sentinel Collaborative Ground Segment**, which was introduced with the aim of exploiting the Sentinel missions even further. This entails additional elements for specialised solutions in different technological areas such as data acquisition, complementary production and dissemination, innovative tools and applications, and complementary support to calibration & validation activities.

The Copernicus contributing mission ground segments, with their own specific control functions, data reception, data processing, data dissemination and data archiving facilities, deliver essential data complementary to the Sentinels missions.

1.4.1 Core Ground Segment

The Sentinel Core Ground Segment allows all Sentinel data to be systematically acquired, processed and distributed. It includes elements for monitoring and controlling the Sentinel satellites and for downloading, processing and disseminating the data to the users. It also has mechanisms for monitoring and controlling the quality of the data products, as well as for data archiving. The infrastructure is 'distributed', meaning that various centre's are in different locations but linked together and coordinated. Despite the complexity of the system, users are offered a single virtual access point for locating and downloading the products.

The main facilities of the Sentinel Core Ground Segment are:

- The Flight Operations Segment (FOS) - responsible for all flight operations of the Sentinel satellites, including monitoring and control, execution of all platform activities and commanding of the payload schedules.
- The Core Ground Stations - where the Sentinel data are downlinked and products are generated in near-real time. A network of X-band ground stations allows the downlink of all Sentinel data. These are complemented by the utilisation of the European Data Relay Satellite (EDRS) for additional downlink of Sentinel data to EDRS ground stations.
- The Processing and Archiving Centre's (PACs) - where systematic non-time-critical data processing is performed. All data products are archived for online access by users. A network of PACs supports all the processing and archiving of Sentinels data.
- The Mission Performance Centre's (MPCs) - responsible for calibration, validation, quality control and end-to-end system performance assessment. The MPCs include expert teams for specific calibration/validation, off-line quality control and algorithm correction and evolution activities.
- The Sentinel Precise Orbit Determination (POD) facility - makes use of the GNSS receiver data on the Sentinels to deliver the orbital information needed to generate the data products.
- The Copernicus Space Component Wide Area Network (CSC WAN) - allows all products and auxiliary data to be carried across the various ground segment facilities and provides disseminated data products to the end users.

All Sentinel data are systematically processed up to the designated level and according to different timelines, ranging from near-real time to non-time-critical, available typically within 3-24 hours of being sensed by the satellite.

1.4.1.1 Payload Data Ground Segment (PDGS)

The Payload Data Ground Segment (PDGS) is responsible for exploitation of the instrument data. The PDGS is operated from ESA's Centre for Earth Observation also known as the European Space Research Institute ([ESRIN](#)) in Frascati, Italy. The PDGS operationally generates the [user products](#) and distributes raw Level-0 products, processed Level-1 products and derived Level-2 products.

The PDGS includes the facilities responsible for mission control (mission planning, production planning), quality control (calibration, validation, quality monitoring, instrument performance assessment), precise orbit determination, user services interface and acquisition, processing and archiving.

Real-time sensed data as well as data played back from on-board saved data are downlinked directly to ground or via the European Data Relay Satellite (EDRS), received, down-converted, demodulated and transferred to the processing facilities for systematic generation and archiving of Level-0 and Level-1/2 data products.

The PDGS is expected to receive and process 0.6 TBytes of uncompressed raw data per day for the two satellites in addition to data from all other ESA missions. All [S3-instrument](#) Level-0 data are processed to produce Level-1 and Level-2 products applying all the necessary processing algorithms and formatting techniques.

The PDGS is distributed over several core centres including Core Ground Stations (CGS), Processing and Archiving Centres (PAC), Mission Performance Centres (MPC) and Precise Orbit Determination (POD) facilities.

Core Ground Stations

The X-band Core Ground Stations located in Svalbard, Norway, is responsible for data acquisition and near real-time processing.

•

Processing and Archiving Centres

PACs perform long-term data archiving, data access and systematic non-time-critical data processing. Archiving and long-term preservation of data is ensured for all Level-0 data and for a set of configurable systematic higher level products.

Mission Performance Centres

MPCs are responsible for calibration, validation, quality control and end-to-end system performance assessment. The MPCs include expert teams for specific cal/val, off-line quality control and algorithm correction activities.

Precise Orbit Determination

POD facilities make use of the GNSS receiver data on-board the SENTINEL satellites to deliver the orbital information needed for generation of mission products.

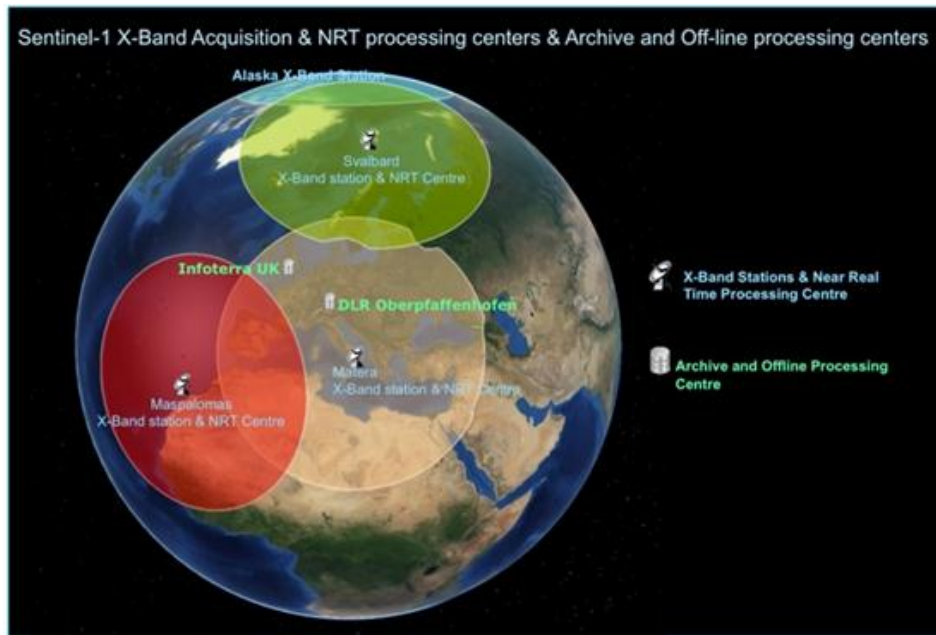

Figure 1-5: Sentinel-3 receiving stations offline processing and archiving centers

Coordination between the centres is provided through the Payload Data Management Centre (PDMC) at ESRIN in Frascati, Italy.

SENTINEL-3 products are provided to the user through online access. Near real-time dissemination is allocated to the receiving stations and less time-critical data dissemination is allocated to the assembly, processing and archiving centers.

1.4.1.2 Flight Operations Segment (FOS)

The Flight Operation Segment (FOS) is responsible for command and control of the satellite and will be operated from ESA’s European Space Operations Centre (ESOC) in Darmstadt Germany for the duration of the Sentinel-3 commissioning phase, and during routine operations by [EUMETSAT](#) in Darmstadt Germany.



Figure 1-6: ESA's European Space Operations Centre (Left) and EUMESAT's Mission Control Center (Right)

The FOS consists of the Ground Station and Communications Network, Flight Operations Control Centre and a General Purpose Communication Network.

The FOS provides the capability to monitor and control the satellite during all mission phases including the Flight Dynamics System facility responsible for orbit determination and prediction, and for the generation of attitude and orbit control tele-commands.

The main functions of the FOS include:

- **Mission planning** - Long term planning of spacecraft and payload activities, covering the complete orbit cycle and repeating indefinitely. Short term planning, nominally every 2 weeks, in the form of updated mission schedules.
-
- **Spacecraft status monitoring** - Taking control actions by means of tele-commands, based on the spacecraft monitoring and following the mission plan.
-

Spacecraft control

Processing housekeeping telemetry, providing information about the status of all spacecraft subsystems and altitude.

Orbit determination and control

Using tracking data and implementing orbit manoeuvres, ensuring required orbital conditions are achieved.

Attitude determination and control

Using processed attitude sensor data from spacecraft monitoring and by commanded updates of control parameters through the on-board attitude control system.

On-board software maintenance

Integrating software images received from the spacecraft manufacturer (pre-launch and post-launch) into the tele-command process.

Communications

Communicating (TM/TC) with one satellite at a time.

1.5 Observation scenario

The SENTINEL-3 observation scenario implements a pre-defined SENTINEL High Level Observation Plan (HLOP), and is focused on delivering the observation requirements for the Copernicus services. The SENTINEL HLOP can be found [here](#).

The SENTINEL-3 instruments provide the sensing of the data autonomously on-board the spacecraft on the basis of predefined geographic data and selection of observation mode depending on the surface over which the spacecraft is flying. This mode of operation does not require any specific request from users, and ground-based routine operations planning of the spacecraft is extremely simple. The SENTINEL-3 instruments autonomously perform systematic and continuous sensing as follows:

- The OLCI instrument, in observation mode, acquires data over daylight part of the orbit (i.e. for a sun zenith angle below 80 deg).

In addition, and in order to maintain the performance of the instrument during the mission lifetime, at regular intervals throughout the Mission, the instrument is placed in [calibration mode](#).

For more information on the OLCI coverage please visit the [Coverage](#) section of the [User Guide](#).

- The SLSTR instrument, in observation mode, operates the infra-red and SWIR channels over the whole orbit, and the visible channels out of eclipse only. In addition to maintain the performance of the instrument, a [calibration mode](#) is also used.

For more information on the SLSTR coverage please visit the [Coverage](#) section of the [User Guide](#).

- The SRAL instrument acquires data over the whole orbit in 100% SAR mode.
- The MWR instrument operates over the whole orbit.

1.6 Mission status

- [Mission Status Report 30: 23 November - 15 December 2016](#)
- [Mission Status Report 29: 20 October - 23 November 2016](#)
- [Mission Status Report 28: 13 - 20 October 2016](#)
- [Mission Status Report 27: 07 September - 12 October 2016](#)
- [Mission Status Report 26: 31 August - 07 September 2016](#)
- [Mission Status Report 25: 13 - 28 August 2016](#)
- [Mission Status Report 24: 28 July - 12 August 2016](#)
- [Mission Status Report 23: 21 - 27 July 2016](#)
- [Mission Status Report 22: 13 - 20 July 2016](#)
- [Mission Status Report 21: 02 - 08 July 2016](#)
- [Mission Status Report 20: 25 June - 01 July 2016](#)
- [Mission Status Report 19: 18 - 25 June 2016](#)
- [Mission Status Report 18: 11 - 17 June 2016](#)
- [Mission Status Report 17: 04 - 10 June 2016](#)
- [Mission Status Report 16: 28 May - 03 June 2016](#)
- [Mission Status Report 15: 21 - 27 May 2016](#)
- [Mission Status Report 14: 14 - 20 May 2016](#)
- [Mission Status Report 13: 07 - 13 May 2016](#)
- [Mission Status Report 12: 30 April - 06 May 2016](#)
- [Mission Status Report 11: 23 - 29 April 2016](#)
- [Mission Status Report 10: 16 - 22 April 2016](#)
- [Mission Status Report 9: 09 - 15 April 2016](#)
- [Mission Status Report 8: 02 - 08 April 2016](#)
- [Mission Status Report 7: 26 March - 01 April 2016](#)
- [Mission Status Report 6: 19 - 25 March 2016](#)
- [Mission Status Report 5: 12 - 18 March 2016](#)
- [Mission Status Report 4: 05 - 11 March 2016](#)
- [Mission Status Report 3: 27 February - 04 March 2016](#)
- [Mission Status Report 2: 20 - 26 February 2016](#)
- [Mission Status Report 1: 16 - 19 February 2016](#)

1.7 Operation ramp-up phase

The operations ramp-up phase refers to the period starting at the completion of the first spacecraft launch and commissioning, and continues until the Full Operational Capacity (FOC) is reached with the constellation. Major milestones are listed below:

16 February 2016	Successful Launch of S3A from Plesetsk, Russia.
18 February 2016	LEOP phase concluded successfully <ul style="list-style-type: none"> ✓ Perfect orbit injection from the launcher ✓ Rapid and smooth Solar Array deployment ✓ Only one minor anomaly encountered (Star Tracker depointing due to incorrect quaternion data), rapidly identified and corrected
26 February 2016	Platform In-Orbit Verification completed
04 March 2016	Payload In-Orbit Verification completed <ul style="list-style-type: none"> ✓ All instrument ON and operating (except SLSTR in decontamination mode, as planned) ✓ Level-0 products being generated
07 March 2016	Cal/Val Phase of S3A commences
April/May 2016	Mid-Term-Reviews for OLCI, SLSTR and SRAL
mid- May 2016	Release of Level 1 and Level 2 sample data products to expert users for all instruments
28-30 June 2016	Expert users meeting – first feedback from S3 validation teams
11/12 July 2016	In-Orbit Commissioning Review (IOCR)– successful completion of commissioning phase, start of ramp-up phase (initial operational)
13 July 2016	ESA internal handover from development to operations team; Handover of flight operations from ESA to EUMETSAT
10 October 2016	Handover of Marine PDGS from ESA to EUMETSAT
20 October 2016	Release of OLCI Level 1 core data to all users
w/c 14 November 2016 (TBC)	Release of SLSTR Level 1 core data to all users
Early December 2016 (TBC)	Release of SRAL L1A, L1B and L2 NRT and STC core data to all users
January 2017	Release of SRAL L1B core data to all users
Early 2017	Release of OLCI Level 2 and SLSTR Level 2
IOCR + 9 months	RORR: Routine Operation Readiness Review. End of S3A ramp-up phase.
Q3 2017	Release of Aerosol Optical Depth (AOD) and Fire Radiative Power (FRP) products
End 2017	Launch of Sentinel-3B

1.8 Instrumental Payload

The SENTINEL-3 satellite carries the following payload instruments:

- a push-broom imaging spectrometer instrument called the [Ocean and Land Colour Instrument](#) (OLCI)
- a dual view (near-nadir and backward views) conical imaging radiometer called the [Sea and Land Surface Temperature Radiometer](#) (SLSTR) instrument
- a dual-frequency SAR altimeter called the [SAR Radar Altimeter](#) (SRAL) instrument
- a [Microwave Radiometer](#) (MWR) instrument, supporting the SRAL in achieving overall altimeter mission performance by providing wet atmosphere correction
- a [Precise Orbit Determination](#) package including a Global Navigation Satellite Systems (GNSS) instrument, a Doppler Orbit determination and Radio-positioning Integrated on Satellite (DORIS) instrument and a Laser Retro-Reflector (LRR).

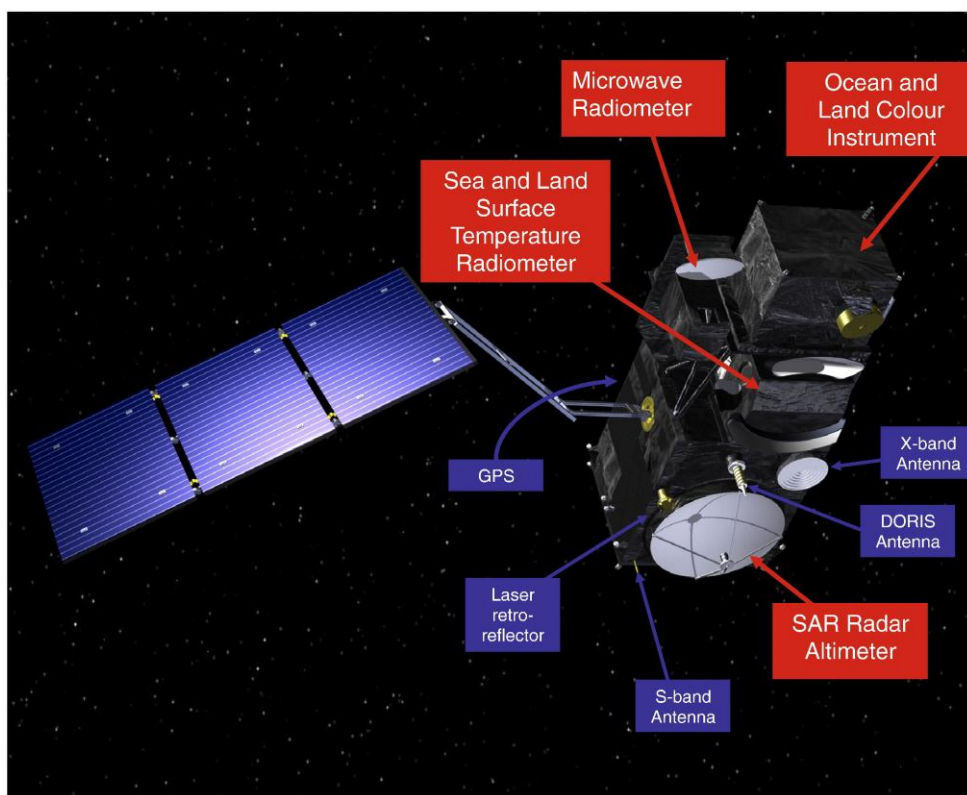

Figure 1-7: Sentinel-3 Payloads (credit:ESA)

1.8.1 OLCI Instrument Payload

The SENTINEL-3 [Ocean and Land Colour Instrument \(OLCI\)](#) is based on the opto-mechanical and imaging design of ENVISAT MERIS. The main characteristics of the OLCI are:

- swath width: 1 270 km

- push-broom imaging spectrometer with five cameras, mitigation of sun-glint contamination by tilting cameras in westerly direction
- spatial sampling: 300 m @ SSP
- spectrum: 21 bands [0.4-1.02] μm
- radiometric accuracy: 2% abs, 0.1% rel
- launch mass: 153 kg
- size: 1.3 m³
- design lifetime: 7.5 years.



Figure 1-8: SENTINEL-3 OLCI Instrument (Credit: ESA)

1.8.2 SLSTR Instrument Payload

Following ENVISAT AATSR, the SLSTR instrument is a conical scanning imaging radiometer employing the along track scanning dual view technique.

The main characteristics of the SLSTR are:

- swath width: dual view scan, 1 420 km (nadir) / 750 km (backwards)
- spatial sampling: 500 m (VIS, SWIR), 1 km (MWIR, TIR)
- spectrum: nine bands [0.55-12] μm
- noise equivalent dT: 50 mK (TIR) at 270 K
- launch mass: 90 kg
- size: 2.116 m³
- design lifetime: 7.5 years.



Figure 1-9: SENTINEL-3 SLSTR Instrument (Credit: Selex-Galileo & Jena-Optronik)

1.8.3 Altimetry Instruments Payload

The main characteristics of the [SRAL](#) (SENTINEL-3 Ku/C Radar Altimeter) are:

- radar measurement modes: LRM and SAR
- tracking modes: closed and open-loop
- pulse repetition frequency: 1.9 KHz (LRM), 17.8 KHz (SAR)
- total range error: 3 cm
- launch mass: 60 kg.

The main characteristics of the [MWR](#) (MicroWave Radiometer) are:

- dual frequency, 23.8 / 36.5 GHz
- radiometric accuracy, 3 K absolute (0.6 K relative)
- launch mass: 26 kg.

Precise Orbit Determination (POD) including:

- [GNSS](#) receiver (Global Navigation Sat. System)
- [DORIS](#) Doppler Orbitography and Radiopositioning Integrated by Satellite
- [LRR](#) Laser Retro reflector

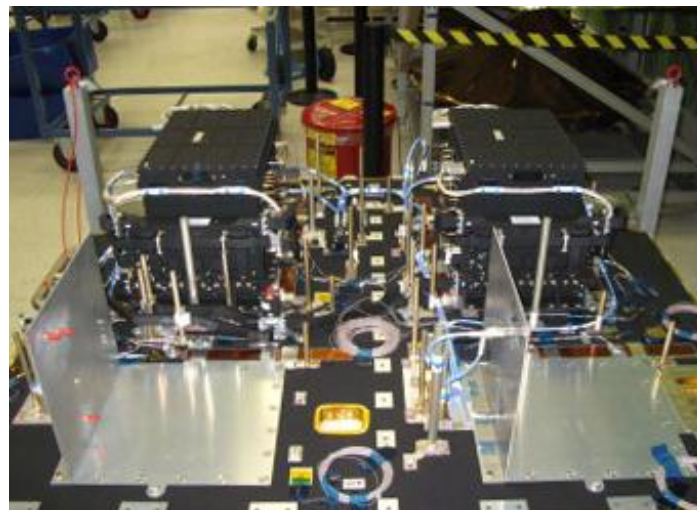

Figure 1-10: SRAL Instrument (Credit: ESA)

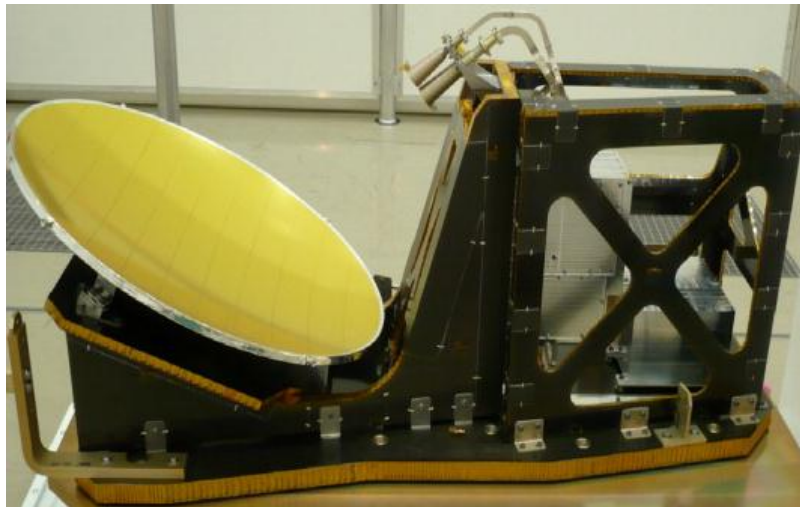

Figure 1-11: MWR Instrument (Credit: ESA)



Figure 1-12: DORIS Instrument (Credit: ESA)

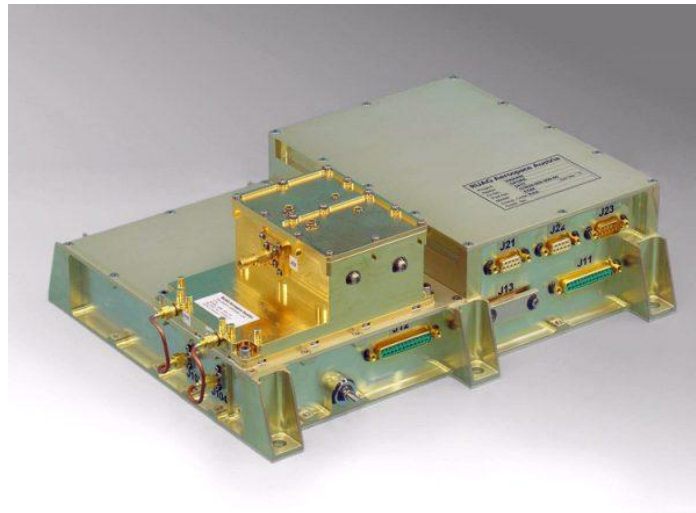

Figure 1-13: GNSS Instrument (Credit: ESA)



Figure 1-14: LRR Instrument (Credit: ESA)

1.9 Data Products

The SENTINEL-3 PDGS implements complete processing chains for generating ocean colour and land reflectance, land and sea temperature and ocean and land topography products as shown in the figure below.

SENTINEL-3 processing derives SPOT Vegetation-like data products using the combined OLCI and SLSTR instrument data.

The SENTINEL-3 synergy products replicate the attributes and quality of standard 1 km SPOT Vegetation products through innovative spectral remapping and co-location techniques.

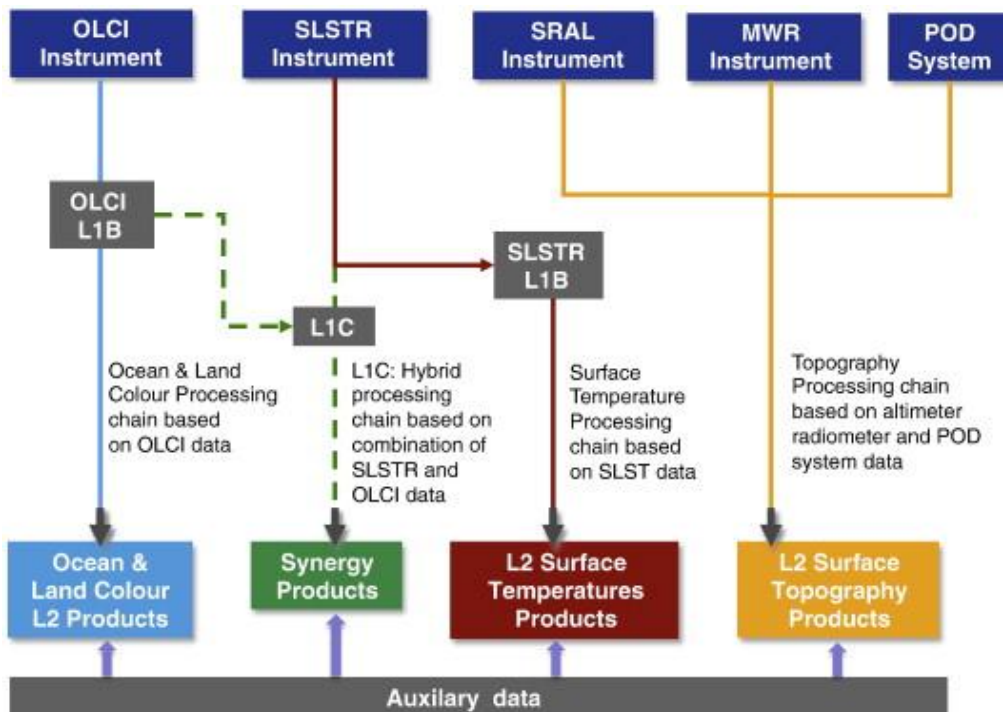
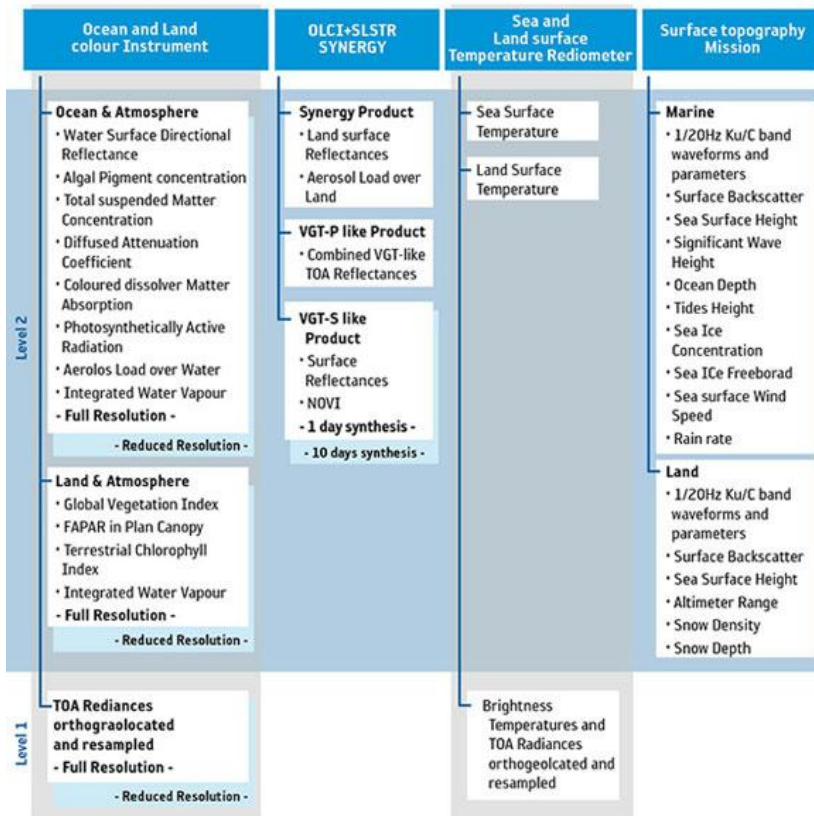

Figure 1-15: Graphical Representation of SENTINEL-3 Core Products.

1.9.1 User Products Dissemination Concept

The Sentinel-3 user products are disseminated in Product Dissemination Units (PDU), in order to ease the online dissemination and data handling for the users.

The PDU is a portion of data and is defined per product type. Three kinds of PDU are defined for Sentinel-3 products: “frame”, “stripe” (see Figure 1-16) and “tile”.

- A frame is identified by means of a fixed reference system based in along track coordinates and along orbit cycle coordinate. The along-track coordinate identifies the product frame start point with respect to a fixed orbit position (like the ANX). Each frame is stepped by a constant time interval along the orbit track. The along orbit cycle coordinate identifies the relative orbit number within the orbit cycle.
- A stripe coincides either with the acquisition dump or with a defined acquisition time segment whose length may differ according to the instrument type (for example full orbit pole to pole, half orbit etc...). A special case of stripe is provided by the Vegetation like product (called VGT-P) where the stripe is mapped on a Plate Carrée geographical projection
- Tiles are defined only for Vegetation-like 1 or 10 days synthesis products, VGT-S1 (SY_2_VG1) and VGT-S10 (SY_2_V10), provided on a Plate Carrée map projection. A tile corresponds to a geographical subset of the synthesis image as shown in Figure 1-17.

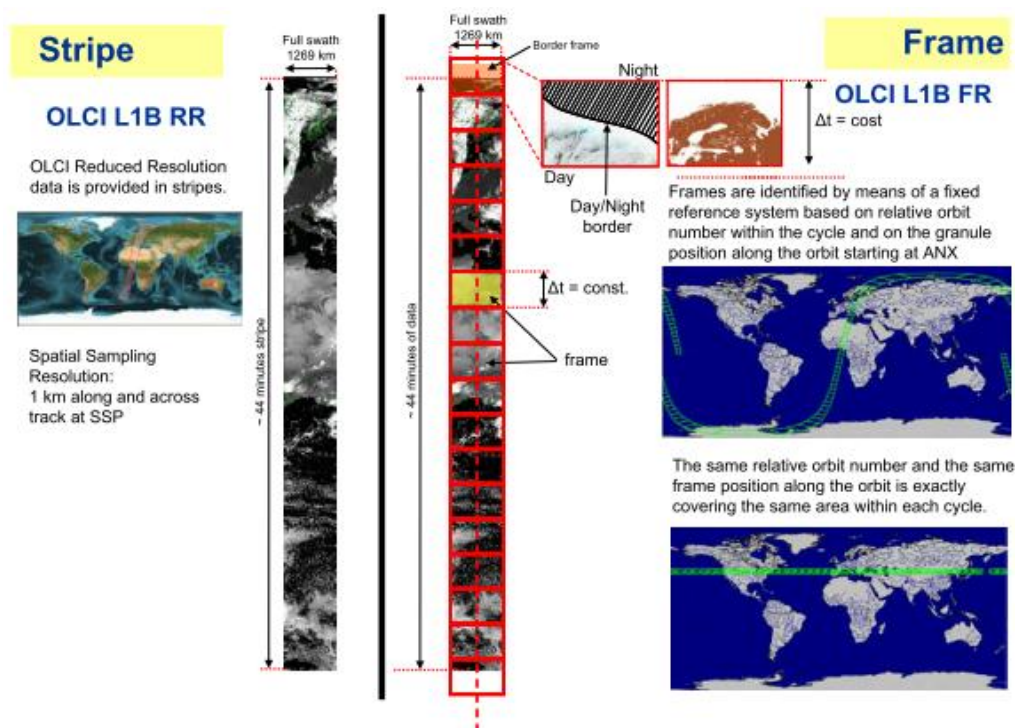

Figure 1-16: Example of PDUs for OLCI L1B products : stripe and frame concept

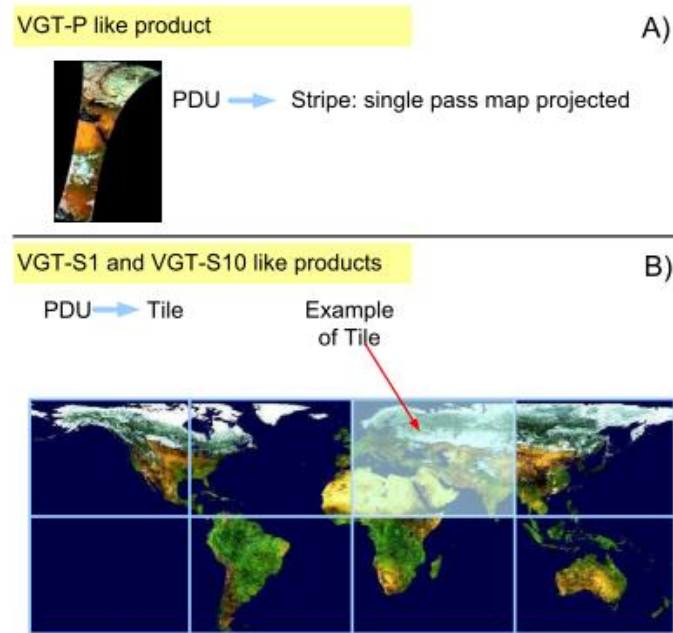

Figure 1-17: Example of PDUs for Vegetation-like products

1.9.2 OLCI

There are different data products associated with the three levels of processing of OLCI:

- [Level-0](#) is the reconstructed and time-sorted Instrument Source Packet (ISP) at full space-time resolution. All communications artefacts (e.g. synchronisation frames, communications headers and duplicate data) and invalid packets are removed. OLCI data is always sensed in full resolution mode (300 m resolution).
- [Level-1](#) includes Top-Of-Atmosphere (TOA) radiometric measurements, radiometrically corrected, calibrated and spectrally characterised. It is quality controlled, ortho-geolocated (latitude and longitude coordinates, altitude) and annotated with satellite position and pointing, landmarks and preliminary pixel classification (e.g. land/water/cloud masks). Products are generated in FR (300 m) and in RR (1.2 km) for the whole globe with the same coverage.
- [Level-2](#) products consist of geophysical quantities derived from the processing of measurement data provided in the Level-1 product. Level-2 products specifically for marine and land application domains are generated separately by the SENTINEL-3 PDGS, with each containing the parameter relevant for the specific field of application. Level-2 atmospheric information relevant for both application domains, such as water vapour, is reported in both data streams.

OLCI Level-1 and 2 data products are available to the general public.

The OLCI files are collected into a SAFE container. Level-1 and 2 products will be encapsulated in free-standing netCDF 4 product files.

The timeframe for delivery of products is dependent on the specific application:

- Near Real-Time (NRT) products are delivered to the users less than 3 hours after acquisition of the data by the sensor

- Non-Time Critical (NTC) products are delivered not later than 1 month (commitment) after acquisition or from long-term archives. Typically, the product should be available within 24h or 48h (but this is not guaranteed).

For further information about OLCI products see [Product Types](#).

For further information about OLCI geometric and radiometric resolutions see: [Resolution](#).

For further information about OLCI data formats see: [Data Formats](#).

1.9.3 SLSTR

There are different data products associated with the three levels of processing of SLSTR:

- [Level-0](#) is the reconstructed and time-sorted Instrument Source Packet (ISP), at full space-time resolution. All communications artefacts (e.g. synchronisation frames, communications headers and duplicate data) and invalid packets are removed.
- [Level-1](#) includes Top-Of-Atmosphere (TOA) radiometric measurements, radiometrically corrected, calibrated and spectrally characterised. It is quality controlled, ortho-geolocated (latitude and longitude coordinates, altitude) and annotated with satellite position and pointing, landmarks and preliminary pixel classification (e.g. land/water/cloud masks).
- [Level-2](#) products consist of geophysical quantities derived from the processing of the measurements data provided in the Level-1 product. Level-2 products specifically for marine and land application domains are generated separately by the SENTINEL-3 PDGS, with each containing the parameter relevant for the specific field of application.

SLSTR Level-1 and 2 data products are available to the general public.

The SLSTR files are collected into a SAFE container. Level-1 and 2 products will be encapsulated in free-standing netCDF 4 product files.

The timeframe for delivery of products is dependent on the specific application:

- Near Real-Time (NRT) products, delivered to the users in less than 3 hours after acquisition of data by the sensor.
- Non-Time Critical (NTC) products delivered not later than 1 month (commitment) after acquisition or from long-term archives. Typically, the product should be available within 24h or 48h (but this not guaranteed).

For further information about SLSTR products see [Product Types](#).

For further information about SLSTR geometric and radiometric resolutions see: [Resolution](#).

For further information about SLSTR data formats see: [Data Formats](#).

1.9.4 Synergy

There are four main data products and two internal products associated with the two levels of Synergy processing.

- SYN Level-1 processing aims to retrieve the OLCI and SLSTR radiances and brightness temperature in their acquisition geometry. The same computation is done for their associated annotations. In addition, this processing aims to compute the correspondence grids between OLCI reference channel and all other OLCI and SLSTR channels.

- SYN Level-2 processing aims to combine information from the OLCI and SLSTR instruments to provide improved data for land surface analysis.

For further information about SYN products see [Product Types](#).

For further information about SYN geometric and radiometric resolutions see: [Resolution](#).

For further information about SYN data formats see: [Data Formats](#).

1.9.5 Altimetry

There are different data products associated with the three levels of processing of the altimeter data:

- [Level-0](#) is the raw telemetered data, geolocated and dated.
- [Level-1](#) is the Level-0 data corrected for instrumental effects.
- [Level-2](#) is the Level-1 data corrected for geophysical effects.

SRAL/MWR Level-2 products are available to the general public.

The SRAL/MWR files are collected into a SAFE container. Level-1 and 2 products will be encapsulated in free-standing netCDF 4 product files.

There are different data product types depending on delivery time to users and the available consolidated auxiliary or ancillary data:

- Near Real-Time (NRT): delivered less than 3 hours after data acquisition, and mainly used for marine meteorology and ocean-atmosphere gas transfer studies (and possibly for operational oceanography depending on orbit accuracy)
- Slow Time Critical (STC): delivered within 48 hours after data acquisition, due mainly to the consolidation of some auxiliary or ancillary data (e.g. preliminary restituted orbit data) and the data are mainly used for geophysical studies and operational oceanography.
- Non Time Critical (NTC): typically delivered within 1 month after data acquisition. This additional delay allows consolidation of some auxiliary or ancillary data (e.g. precise orbit data) and the data are mainly used for geophysical studies and operational oceanography.

For further information about SRAL/MWR Level-2 products see [Product Types](#)

For further information about delivery time latency see: [Near Real-Time or Non Time Critical?](#)

For further information about SRAL/MWR Level-2 products data formats see: [Data Formats & Size](#)

2 SENTINEL-3 ALTIMETRY USER GUIDE

The **SENTINEL-3 Altimetry User Guide** provides a high level description of the available instrument operating modes and products. It also covers an introduction to relevant application areas, product types, processing levels, resolutions, coverage, product formatting and software tools available from ESA.

The categories are:

- [Overview](#)
Gives a brief description of the altimetry principles, precursor missions, operating modes and the geophysical parameters measured.
- [Applications](#)
The main application of the SENTINEL-3 topography mission is the study of ocean topography including mean sea level, wave height, wind speed over the surface, sea-ice, ocean currents, Kelvin and Rossby waves, eddies and tides.
- [Product Types](#)
Describes the three types of SENTINEL-3 altimetry products as well as the latency products (Near Real-Time, Short Time Critical or Non-Time Critical).
- [Processing Levels](#)
Illustrates the processing steps from Level-0 to Level-2 of SENTINEL-3 altimetry products.
- [Resolutions](#)
Defines the transmitting pattern, sampling and resolution cells of the SENTINEL-3 altimetry mission.
- [Coverage](#)
Describes the geographical coverage, orbit characteristics and revisit time.
- [Naming Conventions](#)
Describes the data naming conventions used for the Level-1 and Level-2 altimetry products made available to users.
- [Data Formats & Size](#)
Outlines the format of the Level-1 and Level-2 products: netCDF and SAFE.
- [Software Tools](#)
Describes the Basic Radar Altimetry Tool (BRAT) used for reading and visualising Level-2 altimetry products.
- [Data Access](#)
Describes data access to SENTINEL-3 data.
- [Definitions](#)
Provides information on definitions, units and conventions used in SENTINEL-3 altimetry mission.

For an in-depth description of the SENTINEL-3 mission altimetry products and algorithms and details of the SRAL instrument and its performance, refer to the **SENTINEL-3 Altimetry Technical Guide**. The Technical Guide will provide a point of engagement for ESA and the SENTINEL technical user community. The detailed information available in the Technical Guide is intended for users such as academics and industrial software engineers who have previous experience of similar EO missions, and in-depth experience of data manipulation and management.

2.1 Overview

The main application of the **SENTINEL-3 topography mission is the study of ocean topography** including mean sea level, wave height, wind speed over the surface, sea-ice, ocean currents, Kelvin and Rossby waves, eddies and tides.

The geophysical parameters to be measured by the SENTINEL-3 topography mission are:

- **Sea Surface Height (SSH)**

- **Significant Wave Height (SWH)**
- **Wind speed over ocean** surface.

The goal of the SENTINEL-3 mission is to provide operational measurements for 20 years using robust and stable altimetry technology already proven in previous ESA missions. The minimum baseline altimeter performance required shall be the same as ENVISAT and CRYOSAT altimeters.

The SENTINEL-3 orbit (altitude, inclination and coverage) is almost the same as ENVISAT, allowing continuation of the ERS/ENVISAT time series.

In the SENTINEL-3 SRAL mission, there are two main modes of operation:

- **High Resolution Mode** commonly called Synthetic Aperture Radar (SAR).
- **Low Resolution Mode (LRM)**

The SRAL mission is always operated at High Resolution Mode. Low Resolution Mode is back-up mode only.

A Level-2 SRAL/MWR complete product contains three data files:

- a **"reduced"** (Red) data file, containing a subset of the main 1 Hz Ku band parameters
- a **"standard"** (Std) data file containing the standard 1 Hz and 20 Hz Ku and C-band parameters
- an **"enhanced"** (Enh) data file containing the standard 1 Hz and 20 Hz Ku and C-band parameters, the waveforms and the associated parameters necessary to reprocess the data (at least in LRM mode).

The SRAL/MWR Level-2 products are generated in **Standard Archive Format for Europe (SAFE)** format. All the information relevant to the product is gathered into a single package. Inside this package, the specific objects containing measurement data are encoded in **netCDF format**.

There are different levels of **data latency** related to the availability of the auxiliary or ancillary data:

- Near Real-Time (NRT): delivered less than 3 hours after data acquisition
- Slow Time Critical (STC): delivered within 48 hours after data acquisition
- Non-Time Critical (NTC): delivered within typically 1 month after data acquisition.

There are different data products associated with the **three levels of processing** of altimeter data:

- Level-0 (L0) is the raw telemetered data, geolocated and dated
- Level-1 (L1) is the Level-0 data corrected for instrumental effects
- Level-2 (L2) is the Level-1 data corrected for geophysical effects.

Level-1 and Level-2 products are available to users. Level-0 products are not available to users and are considered only as inputs to Level-1 processing.

The SENTINEL-3 SRAL geophysical error estimates for the altimeter are shown in Table 1.

Table 1: Major error terms for altimeter height estimation. All data in this table are derived using a 1 Hz integration time and a 2 m Hs. Reference: ESA

Parameter	NRT	NRT	STC	STC	NTC	NTC
- (cm)	Threshold	Goal	Threshold	Goal	Threshold	Goal
Range Noise	3.0	2.0	3.0	2.0	3.0	2.0

Sea State bias	5.0	2.0	3.0	2.0	2.0	1.4
Ionosphere	3.0	2.0	1.4	1.0	1.0	0.7
Dry Troposphere	3.0	2.0	1.4	1.0	1.4	1.0
Wet Troposphere	4.0	3.0	2.0	1.4	1.0	1.0
RSS Range Error	8.3	6.0	5.0	3.5	4.1	2.9
Radial Orbit Error	10.0	8.0	4.0	3.0	3.0	2.0
RSS SSH Error	13.0	10.0	6.5	4.6	5.1	3.5

The ESA [S3 Altimetry toolbox](#) tool is used to visualise and operate Level-1 and Level-2 products.

2.1.1 Altimetry principles

Altimetry satellites are able to measure the distance between the satellite and the surface of the Earth. This distance is called range.

Altimetry satellites transmit a radar signal to the Earth. This signal is reflected by the Earth's surface and the satellite receives the reflected signal. The time elapsed between transmission and reception of the radar signal is the key parameter in calculating the distance between the satellite and the ground surface.

In SENTINEL-3, the SRAL instrument measures this elapsed time.

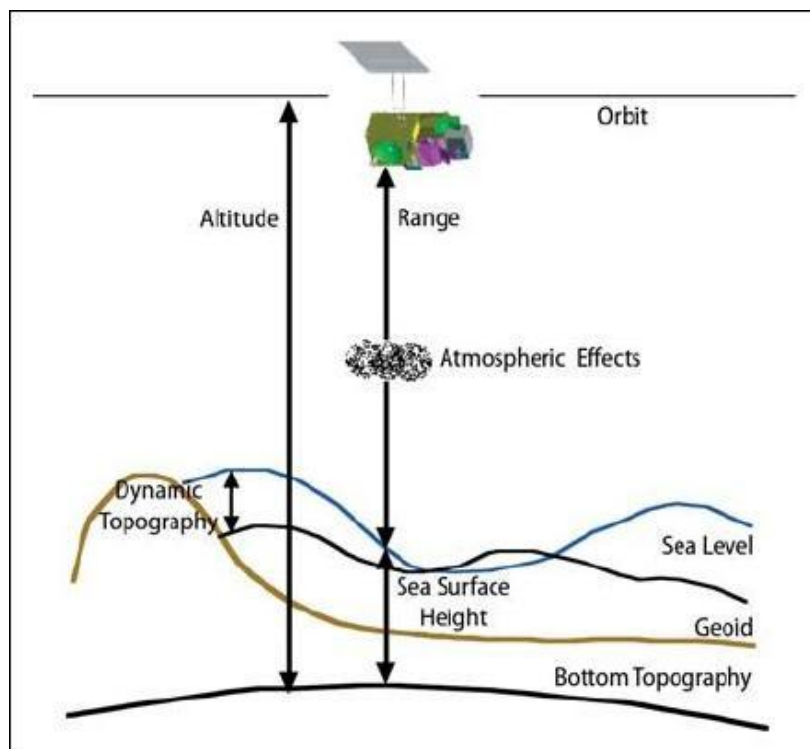

Figure 2-1: Range, Altitude and Sea Surface Height Measurements

Precise orbit altitude is needed to calculate the range. The SENTINEL-3 instruments, GNSS and DORIS, retrieve the orbit altitude. The orbit altitude is the distance between the satellite and an arbitrary reference surface (the reference ellipsoid or the geoid).

The scientific community is usually interested in the surface height in relation to this reference surface (the reference ellipsoid or the geoid) instead of being referenced to the position of the satellite. The surface height can be approximately derived from range and altitude using the following equation:

$$\text{Surface Height} = \text{Altitude} - \text{Range}$$

The complete calculation of surface height should also include all corrections due to environmental conditions. Examples of these corrections are atmospheric propagation corrections (ionosphere and troposphere) and geophysical corrections (tides and atmospheric pressure loading).

2.1.2 Operating modes

In the SENTINEL-3 SRAL mission, there are two main modes of operation:

- **High Resolution Mode**, also known as Synthetic Aperture Radar mode (SAR)
- **Low Resolution Mode (LRM)**

The SRAL mission is always operated at High Resolution Mode (commonly called SAR mode). Low Resolution Mode (LRM) is back-up mode only.

SAR mode is designed to achieve high along-track resolution over relatively flat surfaces. This property can be exploited to increase the number of independent measurements over a given area and is a prerequisite for sea-ice thickness measurements, coastal waters, ice sheet margins, land and inland waters. The scientific justification of High Resolution Mode 100% coverage over the Earth is also applicable to open ocean surfaces because studies have shown that the best performance of this mode is over open ocean surfaces where topography is homogeneous (areas at least as large as the antenna footprint).

LRM employs conventional pulse-limited altimeter operation, as used in the ERS and ENVISAT satellites.

To facilitate autonomous operations, LRM and SAR modes use one of two on-board tracking modes. Traditional autonomous, **closed loop tracking** of range and gain may be used where the altimeter range window is autonomously positioned based on on-board NRT analysis of previous SRAL waveforms. Alternatively, an **open loop tracking** mode is available where the altimeter range window is positioned using a priori knowledge of the surface height stored on-board the instrument in a one-dimensional along track Digital Elevation Model (DEM).

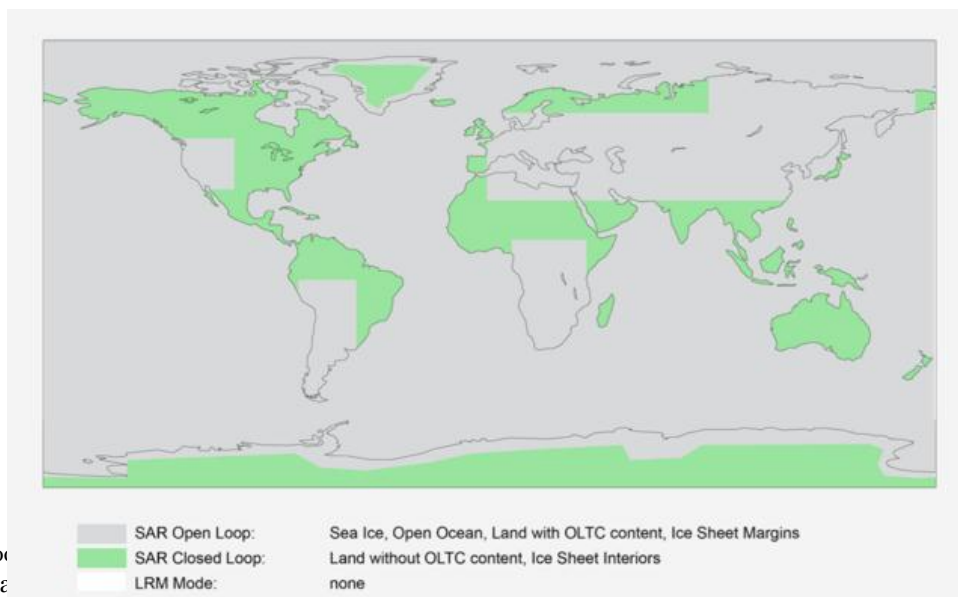

Figure 2-2: SENTINEL-3 operating modes (LRM/SAR) and tracking modes (open loop/closed loop) per observed surface (Credit: ESA)

In the SENTINEL-3 mission, SRAL transmits pulses alternatively at Ku-band (13.575 GHz, bandwidth=350 MHz) main frequency for altimeter range measurements complemented by a C-band frequency (5.41 GHz, bandwidth=320 MHz) that is used to correct range delay errors due to the varying density of electrons in the ionosphere.

2.1.3 Geophysical Measurements

The main geophysical parameters to be measured by the SENTINEL-3 topography mission are:

- **Sea Surface Height (SSH)**
- **Significant Wave Height (SWH)**
- **Wind speed** over ocean surface.

These parameters are retrieved from the physical characteristics of the altimeter waveforms received by the SRAL instrument.

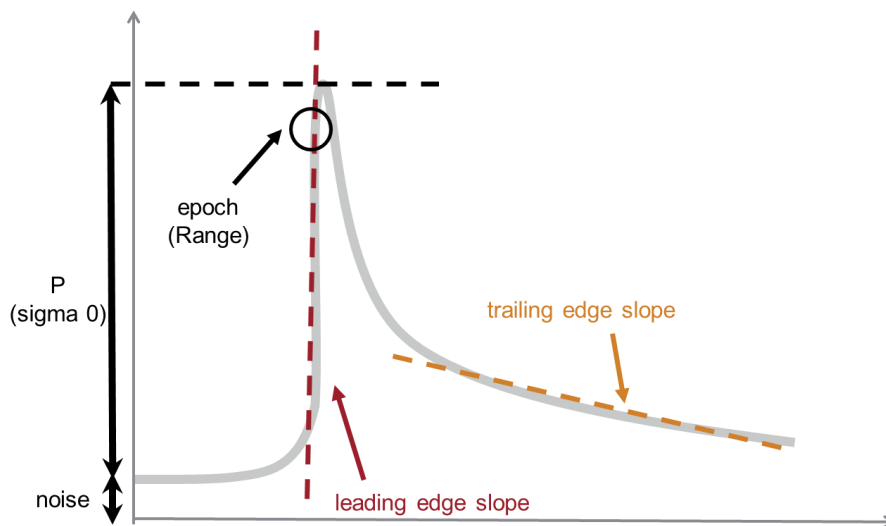

Figure 2-3: Physical Characteristics of the Altimetry Waveforms (Credit: isardSAT)

- Epoch: this is related to the range. SSH is computed from it.
- P: power of the useful signal. This power, with respect to the emitted power, gives the backscatter coefficient, sigma0. Sigma0 (together with the SWH) is used to estimate wind speed.
- Leading edge slope: this can be related to the Significant Wave Height (SWH).
- Trailing edge slope: this is linked to antenna miss-pointing

Parameter	Range	NRT delivery	NTC delivery
SSH	-	10 cm	3.5 cm
SWH	0.5 - 20 m	4%	1%
Wind Speed	0-20 m/s	2 m/s	1.5 m/s

Table 2-1: Measurement requirements for altimetry specified for 1 Hz averaged along track samples

An ensemble of Test Data Sets using simulated data, has been created for different surfaces (e.g. ocean, ice sheets, inland waters), different processing levels (Level-1 and Level-2) and timeliness (NRT, STC and NTC).

2.1.3.1 Sea Surface Height

At present, only altimeter systems are capable of measuring Sea Surface Height (SSH), with which information on ocean circulation patterns and sea levels are determined on a global scale.

SSH is the height of the sea surface with respect to the reference ellipsoid. SSH measurement includes dynamic contributions from ocean circulation and variations in the geoid with respect to the reference ellipsoid. Dynamic topography is the variation in SSH with respect to the geoid.

Sea level anomalies (a variable part of SSH) are usually derived by subtracting the Mean Sea Level (MSL) from the SSH. MSL is SSH, averaged across all the oceans of the globe. An increase in MSL is an indicator of possible global warming.

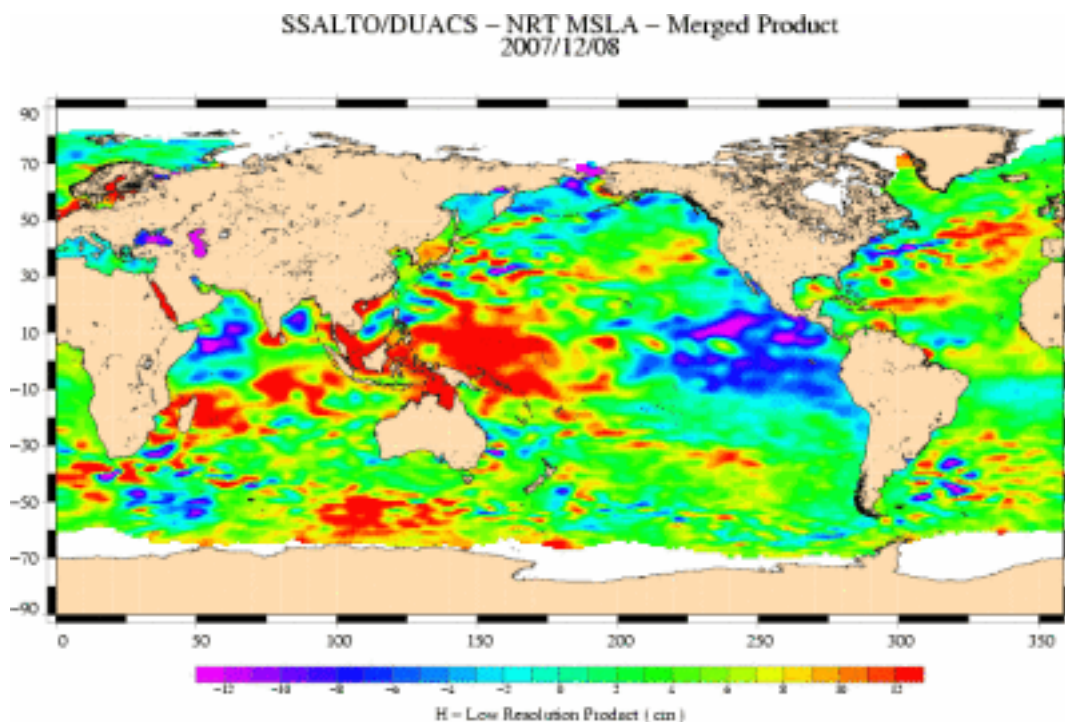

Figure 2-4: The variation of MSL anomalies on a global scale. Positive anomalies indicate more heat content (warmer waters, a deeper thermocline) whereas negative anomalies indicate less heat content (cooler waters, a shallower thermocline). Generally, sea level is higher than average in the northern hemisphere in July and August when waters are warmed by more direct solar radiation and is lower than average in February and March when the incoming solar flux reduces. These sea level anomalies maps derive from a combination of data coming from altimeters on-board JASON-1 and ENVISAT. Feb 2007-Dec 2008 (Credit: CNES/CLS)

The SENTINEL-3 mission SSH goal accuracy is 10 cm for Near Real-Time (NRT) products and 3-5 cm for Slow Time Critical (STC) products.

2.1.3.2 Significant Wave Height

The Significant Wave Height (SWH) is the average wave height (from trough to crest) of the highest third (33.33%) of the waves in a given sample period.

The SENTINEL-3 mission is able to monitor wave heights from 0 to 20 m.

The SENTINEL-3 mission SWH goal accuracy is 4% (8 cm at 2 m SWH) for Near Real-Time (NRT) products and 1% (2 cm at 2 m SWH) for Slow Time Critical (STC products).

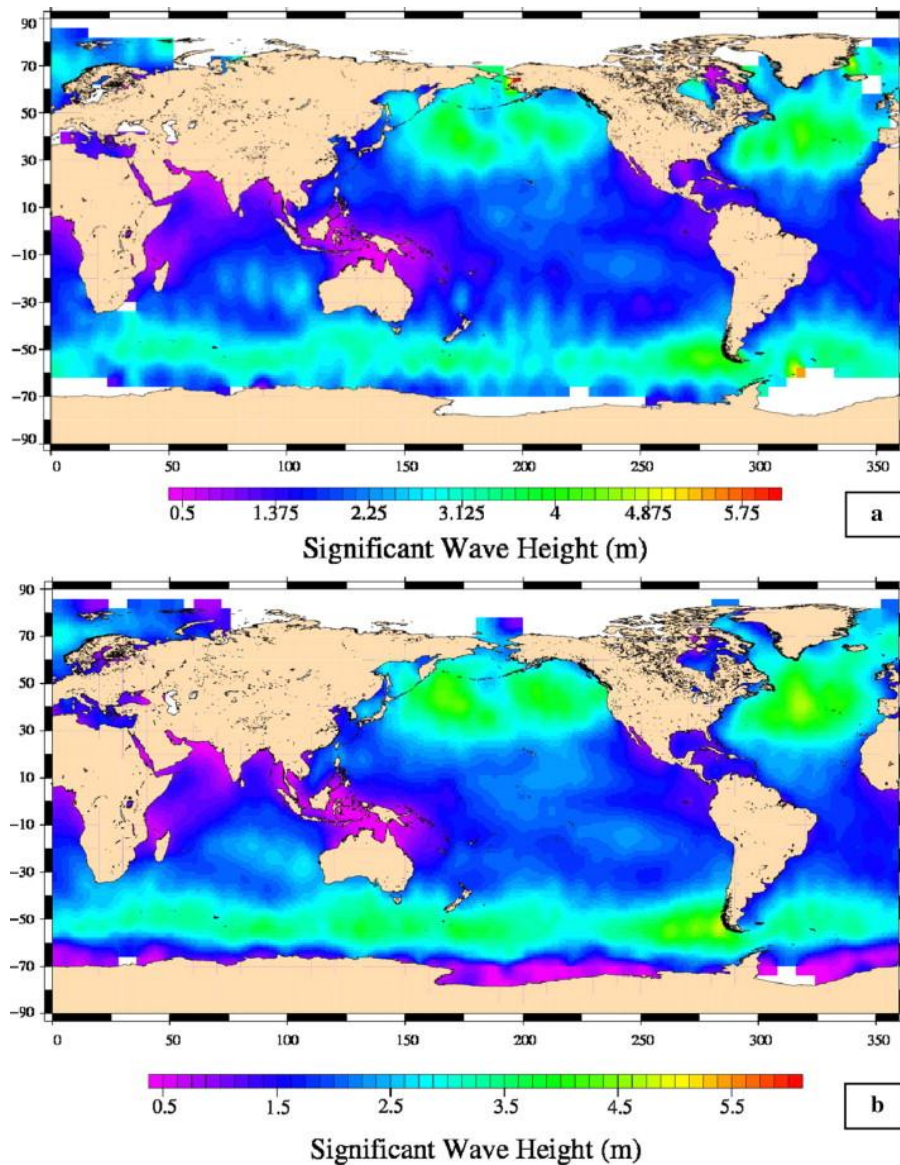

Figure 2-5: CRYOSAT SWH in (m), (a) and ENVISAT SWH in (m), (b), for December 2010

The marine sea state (SWH or H_s) product is a critical product for all maritime safety and rescue operations.

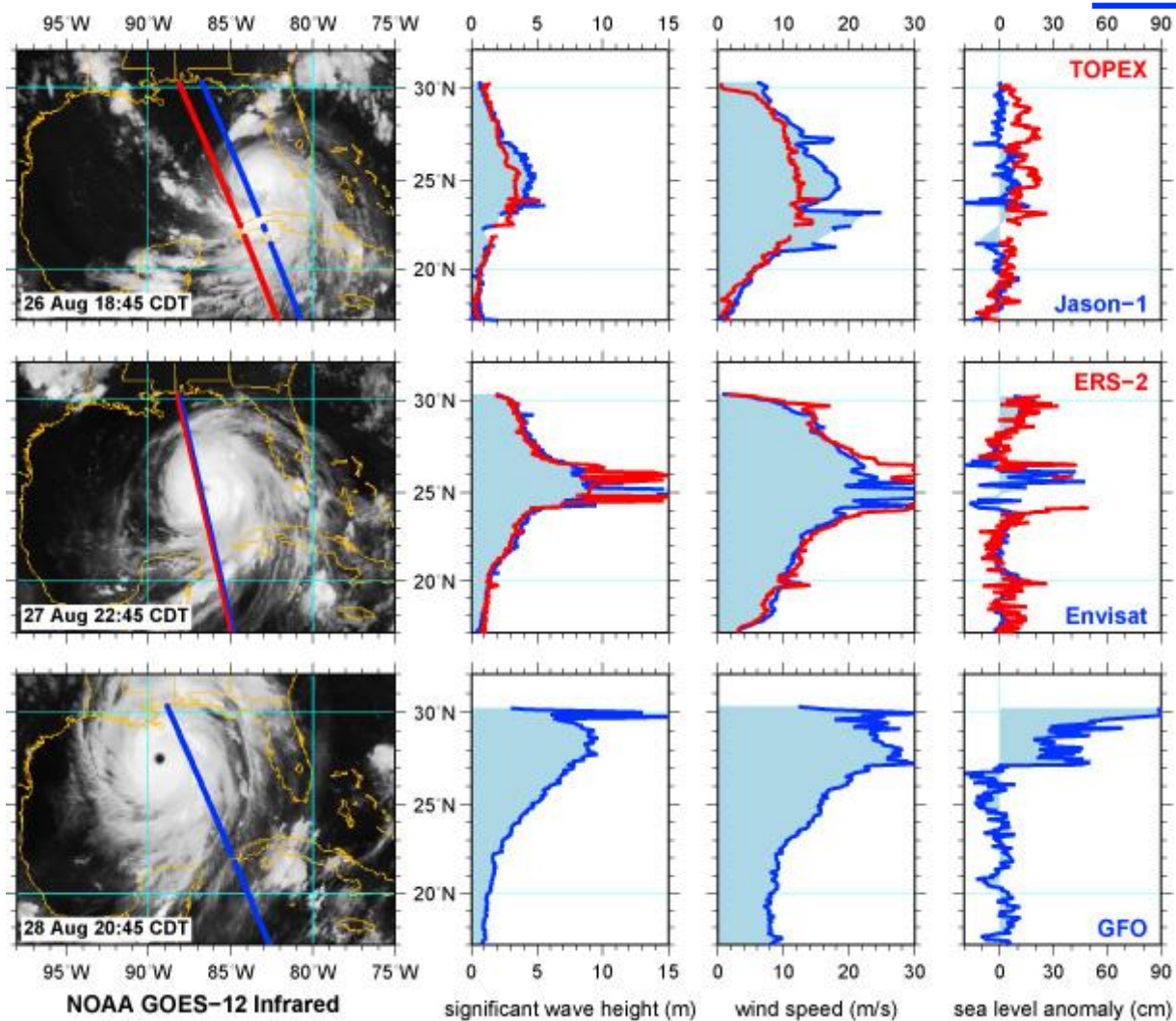

Figure 2-6: SWH (m), wind speed (m/s) and sea level anomalies (cm) as observed by the different altimetry satellites (TOPEX, JASON-1, ERS-2, ENVISAT and GFO – GEOSAT Follow-On mission) during hurricane Katrina August 26-28 2005 (Credit: NOAA/Altimetrics LLC)

2.1.3.3 Wind Speed

The wind speed is the SRAL derived surface wind speed modulus over ocean.

The SENTINEL-3 mission is able to monitor wind speed from 0 to 20 m/s.

The SENTINEL-3 mission wind speed goal accuracy is 2 m/s for Near Real-Time (NRT) products and 1.5 m/s for Slow Time Critical (STC) products.

The SRAL instrument provides estimates of wind speed through relatively well understood geophysical inversion algorithms, based on peak backscattered power and the shape of waveforms.

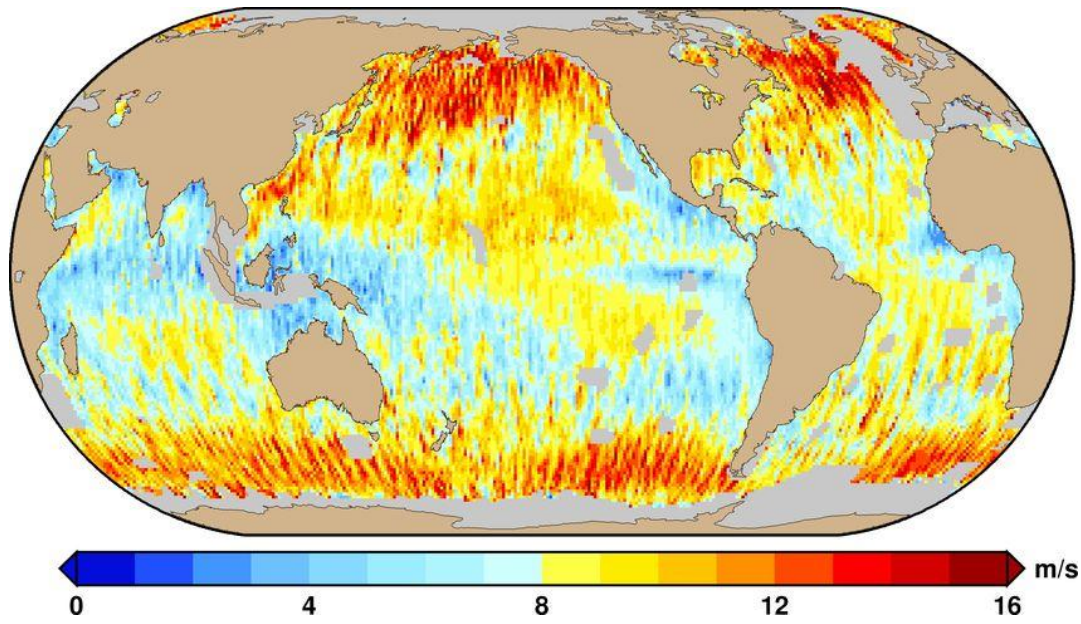

Figure 2-7: Wind Speed (m/s) Over Ocean Using CRYOSAT Data from November 17th to December 13th 2011 (Credit: NOAA)

The wind information (surface wind speed modulus) product is a critical product for all maritime safety and rescue operations.

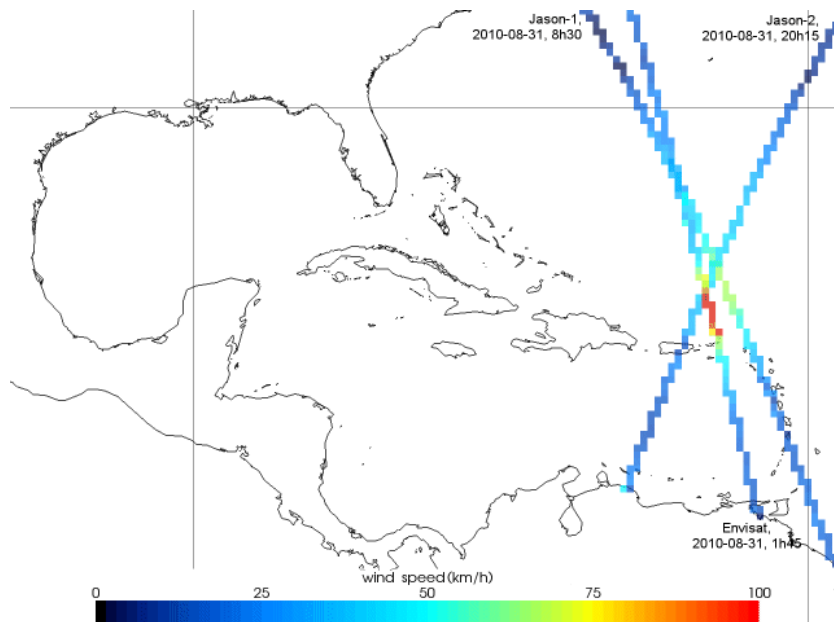

Figure 2-8: Wind Speed (km/h) Measured by ENVISAT, JASON-1 and JASON-2 Missions Close to Hurricane Earl, August 31st 2010 (Credit: AVISO)

2.1.4 Heritage and Future



Figure 2-9: ESA Altimetry Missions: ERS, ENVISAT and CRYOSAT. NASA/CNES Altimetry Missions: GEOSAT, TOPEX-POSEIDON, GFO, JASON-1 and JASON-2.

ESA Altimetry Missions

Since 1991, there has been a continuous series of ESA altimetry missions, starting with [ERS-1](#) (1991) and followed by [ERS-2](#) (1995), [ENVISAT](#) (2002) and [CRYOSAT](#) (2010).

The **objective of the SENTINEL-3 mission is to provide operational measurements for 20 years** using robust and stable altimetry technology already proven in previous ESA missions. The minimum baseline altimeter performance required shall be the same as ENVISAT and CRYOSAT altimeters.

The **altimetry instrument is similar to that of the CRYOSAT mission but with the interferometry mode not included**. CRYOSAT is ESA's dedicated mission to monitor changes in the thickness of marine ice floating in the polar oceans, and to monitor variations in the thickness of the ice sheets covering Greenland and Antarctica. The SENTINEL-3 mission continues the monitoring of the sea state, wind speed, sea-ice and ice thickness as started by the ERS, Envisat and CryoSat mission.

The operating modes available to the SENTINEL-3 mission are High Resolution Mode (commonly called SAR) and Low Resolution Mode (LRM). High Resolution Mode is set for 100% of the coverage for all types of surfaces. LRM is a back-up mode only. LRM is the operating mode used in ENVISAT. High Resolution Mode was also used by CRYOSAT but only operated over sea-ice areas and over some ocean basins and coastal zones. Continuity of the ENVISAT mission is guaranteed by the generation of pseudo-LRM data products from High Resolution Mode data products at Level-1 processing.

The SENTINEL-3 **orbit** (altitude and inclination) is almost the same orbit as ENVISAT, allowing continuation of the ERS/ENVISAT time series.

The C-band **frequency** is a standard chosen in almost all altimetry missions. The S-band frequency was chosen for ENVISAT because the SAR instrument (ASAR) was working on C-band frequencies and the radar altimeter instrument could produce interference to the SAR instrument (ASAR).

The **revisit time** has improved from 35 days (ENVISAT) to 27 days (SENTINEL-3) due to the inclination (98.65° instead of 98.55°) and altitude (815 km instead of 800 km) parameters chosen for the SENTINEL-3 mission.

Mission	Lifetime	Altimetry instrument	Altitude	Inclination	Frequency	Revisit time
ERS-1	July 1991 - June 1996	RA	785 km	98.52°	Ku-band	35 days
ERS-2	April 1995 - June 2003	RA	785 km	98.52°	Ku-band	35 days
ENVISAT	March 2002 - April 2012	RA	800 km	98.55°	Ku-band S-band	35 days
CRYOSAT	April 2010 - Ongoing	SIRAL	717 km	92°	Ku-band	369 days (30 day sub-cycle)
SENTINEL-3	2014 - 2034	SRAL	814.5 km	98.65°	Ku-band C-band	27 days

Table 2-2: ESA altimetry missions' main characteristics

Other Altimetry Missions

The next ESA altimetry mission is SENTINEL-6 in 2020.

See the [Radar Altimeter Tutorial](#) for further information about past, present and future altimetry missions.

2.2 Applications

The first application of the SENTINEL-3 topography mission is the **study of ocean topography** including mean sea level, wave height, wind speed over the surface, sea-ice, ocean currents, Kelvin and Rossby waves, eddies and tides.

The SENTINEL-3 along track SAR capability will improve measurement quality in coastal zones and over sea-ice due to its higher spatial resolution (SAR).

The second application of the SENTINEL-3 topography mission is the **study of land topography** including land-ice, land and inland waters.

Examples of these applications and further descriptions can be found in the blue portlet on the right.

2.2.1 Oceanography

The main applications related to oceanography are:

- **large scale ocean circulation:** studying the ocean currents at the global sea surface ("Mean Dynamic Topography" maps show oceanic relief corresponding to permanent ocean circulation)
- **mesoscale circulation:** studying the sea currents and eddies at spatial scales of approximately 10 - 300 km
- **tides:** due to the combined attraction of the moon and sun, accounting for some of the most significant variations in sea level.

The SENTINEL-3 topography mission is able to provide 100 km resolution maps (large scale) every 10 days with an accuracy of 1 - 2 cm, and 25 km resolution maps (mesoscale) every 7 days with an accuracy of 2 cm.

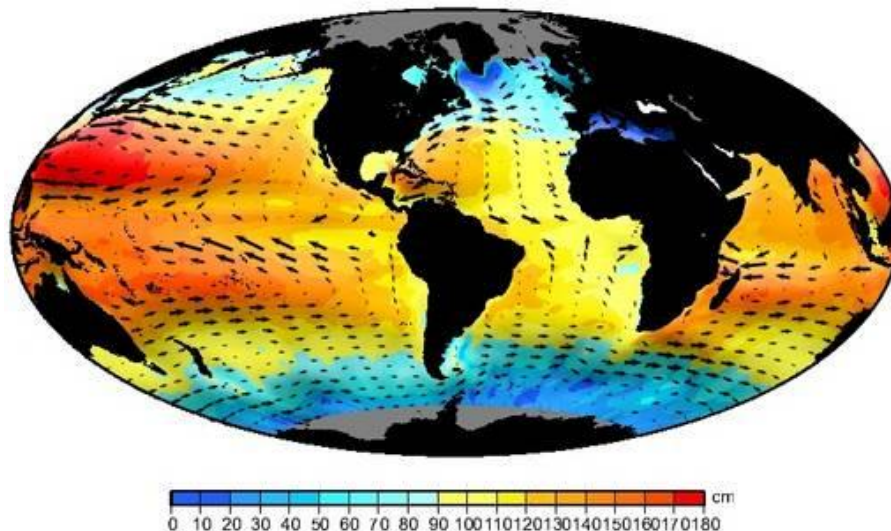

Figure 2-10: Large-scale ocean circulation. Mean Dynamic Topography in cm (i.e. oceanic relief corresponding to permanent ocean circulation). Arrows are proportional to current speed. (Credit: CLS)

Quicktime Animation - Ierapetra gyre at South-East of Crete September-December 2010.

The Ierapetra gyre is a Mediterranean oceanic feature that occurs regularly. This anticyclonic, warm, gyre (turning clockwise, since it is in the Northern hemisphere) forms as a result of northerly wind interactions with the relief on Crete and of ocean circulation in the Kasos strait. The mountains cause the wind to change course, generating swirling movements, which the wind transfers to the sea to form what is known as the Ierapetra gyre.

The strength of this gyre depends on the speed and direction of the wind. This gyre appears, or not, depending on the periods. Variations from year to year are thought to be due to the winds and the mid-Mediterranean jet along the coast of North Africa. In September-December 2010 (see animation), it clearly appears in the sea surface temperature data. It is also tracked by an Argo float trajectory (platform 6900679) that matches the contours of the highest temperatures in the centre of the gyre. (Credit: MyOcean)

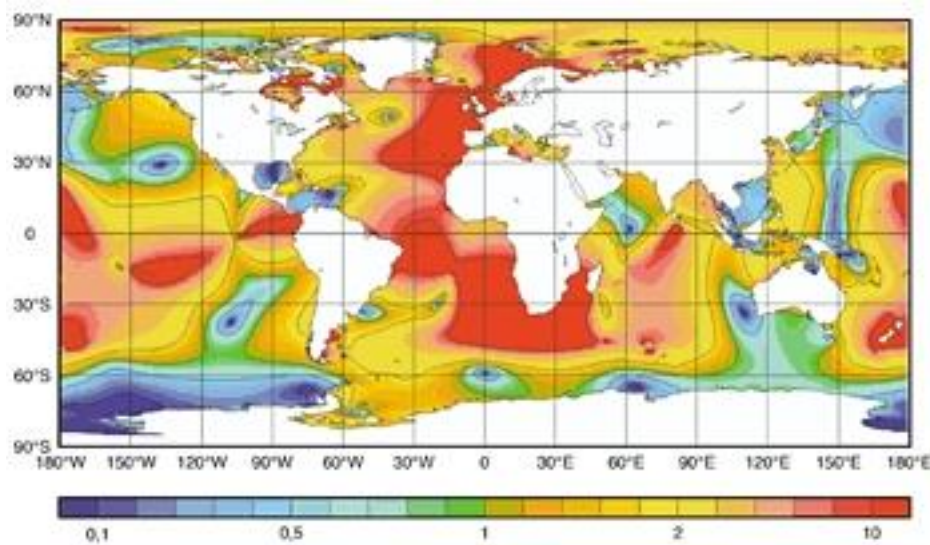

Figure 2-11: Comparison of semi-diurnal and diurnal tides in the world. The blue/violet areas correspond to dominant, diurnal tides, while the yellow/red areas are semi-diurnal. (Credit: CLS/Legos)

For further information about ocean applications related to altimetry, visit the [AVISO](http://www.aviso.oceanobs.com) website.

For further information about ocean applications and services available, see: [Copernicus](http://www.copernicus.eu) website.

2.2.2 Coastal Zones

Altimetry over open ocean is a mature discipline, useful for process studies and operational forecasting. In coastal zones (the strip of land within a few tens of kilometres from a coast) data are often discarded because it is not known how to interpret or model land contamination effects on altimetric waveforms.

There are intrinsic difficulties in making corrections especially in the wet tropospheric component, high-frequency atmospheric and oceanic signals and tides.

The **SENTINEL-3 SRAL improved along track resolution (approximately 250 m) in SAR mode facilitates sea surface height measurement close to the coast.** The SRAL instrument is in SAR mode over coastal zones. The Level-2 SRAL/MWR products have a parameter indicating the distance to the coast as well as dedicated coastal geophysical corrections (e.g. Composite wet tropospheric correction).

New disseminated Level-1 products (Level-1A, Level-1B-s and Level-1B) will allow improving sea surface height measurement over the coast through the possibility of improving and customising land contamination and retracking techniques.

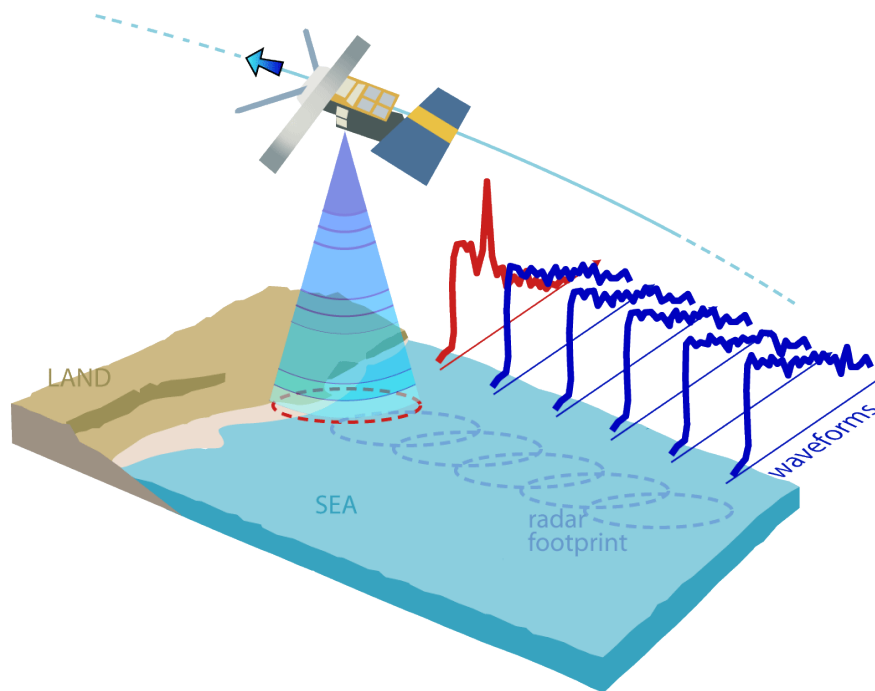

Figure 2-12: Modification of the shape waveforms (in red) when a satellite altimeter approaches the coast entering the radar footprint, making the estimate of range and other derived quantities more difficult. (Credit: COASTALT)

For further information about ocean applications related to coastal altimetry visit the SCOOP project, the CP4O project, the COASTALT project and the PISTACH project websites.

For further information about ocean applications and services available, see: Copernicus website.

2.2.3 Ice and Sea-Ice

The cryosphere plays an important role in moderating the global climate, and as such, the consequences of receding ice cover due to global warming are far-reaching and complex. While evidence suggests that ice sheets are relatively stable, there are indications that rapid changes are occurring around their margins, where the ice reaches the sea: changes that could weaken the ice sheet.

Altimetry is one of the most powerful tools for observing sea ice and ice sheets. For sea ice, altimetry provides a unique way of measuring its thickness. For ice sheets, their topography can be measured by altimeters, at least by those that can reach high latitudes such as Sentinel-3 or CryoSat. Moreover, altimeters also provide other parameters such as backscatter coefficient and waveform shape that give information on surface roughness and snow pack characteristics such as stratification or ice grain size. These parameters are related to relevant unknown quantities affecting the climate, such as snow accumulation rate or snow drift caused by wind.

The SENTINEL-3 improved along track resolution (approximately 250 m) in SAR mode facilitates measurement over sea-ice and land-ice. **The SRAL instrument will be in SAR Open Loop mode over the ice sheet margins, in SAR Closed Loop mode over sea-ice areas and in SAR mode over interior ice sheets.** The Level-2 SRAL/MWR products will have three dedicated outputs for ice sheets, ice and sea-ice.

New disseminated Level-1 products (Level-1A, Level-1B-s and Level-1B) allow improved measurements over the ice-sheets, ice and sea-ice through of improved and customised retracking techniques for these surfaces. The SENTINEL-3 SRAL instrument does not support SAR-In operating mode.

The Sentinel-3 mission shall provide continuity with the ERS, Envisat and CryoSat missions to derive with high resolution the sea-ice thickness and ice sheet topography.

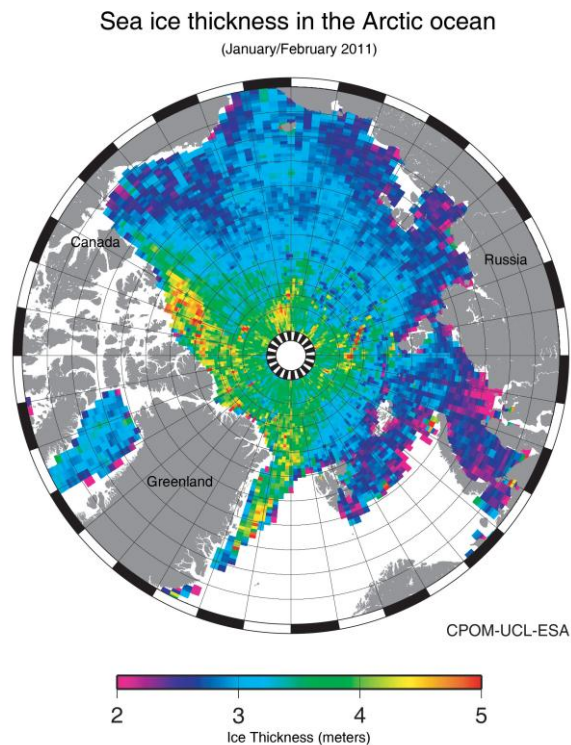

Figure 2-13: Sea-Ice Thickness (m) in the Arctic Ocean (Credit: CPOM/UCL/ESA)

CRYOSAT's exceptionally detailed data have been used to generate the map of sea-ice thickness in the Arctic shown in Figure 2-13. The sea-ice thickness map is based on data from January and February 2011 and shows thicker, rough, multi-year ice north of Canada and Greenland, stretching to the North Pole and slightly beyond.

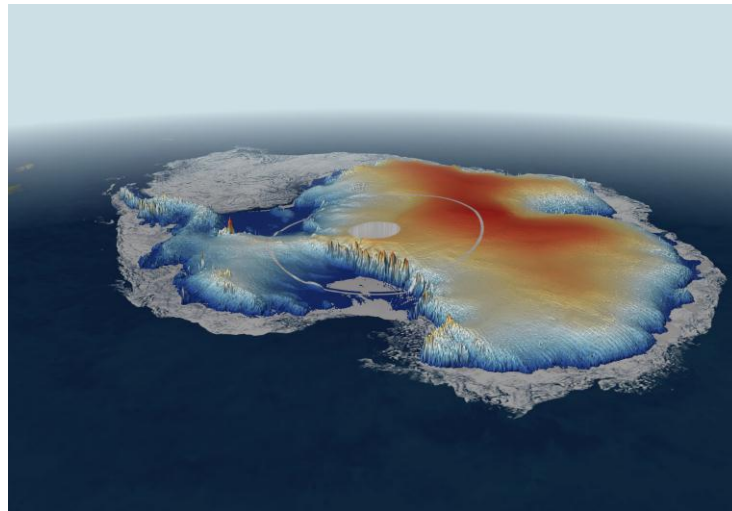

Figure 2-14: Antarctic Ice Thickness Model Based on CRYOSAT Satellite Data (Credit: CPOM/ESA/Planetary Visions)

Data from ESA's CRYOSAT mission have been used to map the height of the ice sheet that blankets Antarctica as shown in Figure 2-14. The data used here are from February and March 2011. CRYOSAT's ability to map the edges of the ice sheet is demonstrated by the detail that can be seen of the flow from east Antarctica onto the Ronne-Filchner ice shelf in the west. Orbiting closer to the poles than other Earth observation missions, CRYOSAT offers additional coverage. The outer white circle represents the limits of earlier missions and the inner circle shows that CRYOSAT is collecting data up to 88° latitude.

For further information about applications related to ice see: Center for Polar Observation and Modelling (CPOM), Ice Sheet Climate Change Initiative, SPICE project and Sea Ice Climate Change Initiative.

For further information about ice and sea-ice applications and services available, see: Copernicus website.

2.2.4 Inland Waters and Land

Rivers and Lakes

The need to globally understand fresh water resources has increased the use of radar altimetry data for measuring river and lake water levels. The advantages of altimetry measurements are the continuity, global coverage and accuracy of the measurements available.

The SENTINEL-3 improved along track resolution (approximately 250 m) in SAR mode facilitates the measurement of narrow rivers and small lakes. The Level-2 SRAL/MWR products will have a field (surface type) indicating whether the records are for enclosed seas or lakes.

New disseminated Level-1 products (Level-1A, Level-1B-s and Level1B) allow improved water level retrieval through improved and customised land contamination and retracking techniques over inland waters.

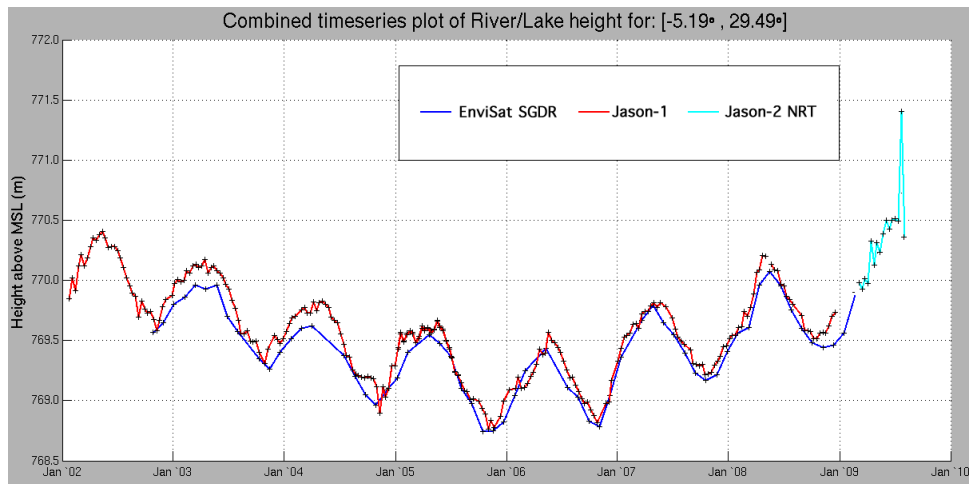

Figure 2-15: Tanganika river water height from January 2002 to January 2010 using ENVISAT, JASON-1 and JASON-2 satellite data. The measurement location is at -5.19 degrees latitude and 29.49 degrees longitude. The height reference is the mean sea level (MSL) surface (Credit: ESA/DMU).

For further information about applications related to river and lake monitoring see: [Rivers and Lakes](#) (ESA), [Hydroweb](#) (LEGOS), [Global Reservoir and Lake Monitoring](#) (US Dept. of Agriculture), [CRUCIAL](#) project and [DAHITI](#) project.

Digital Terrain Models

Detailed and accurate Digital Terrain Models (DTM) are widely used in earth sciences. DTM data derived from in situ and aircraft measurements have historically been available on a regional scale.

Satellite altimeter measurements can be used to derive DTM products and will be of use to Copernicus services. Satellite radar altimetry height estimation, over land targets, requires careful classification of each waveform according to shape, followed by the application of re-tracking algorithms to obtain the best range to surface measurement.

The first altimeter-informed Global Digital Terrain Model (GDTM), Altimeter Corrected Elevations (ACE), was created by fusing altimeter derived heights produced using a system of multiple altimeter re-trackers, with ground-truth from a range of publicly available datasets to create an enhanced GDTM. A new ACE2 dataset was created by synergistically merging the Shuttle Radar Topography Mission (SRTM) dataset together with satellite radar altimetry.

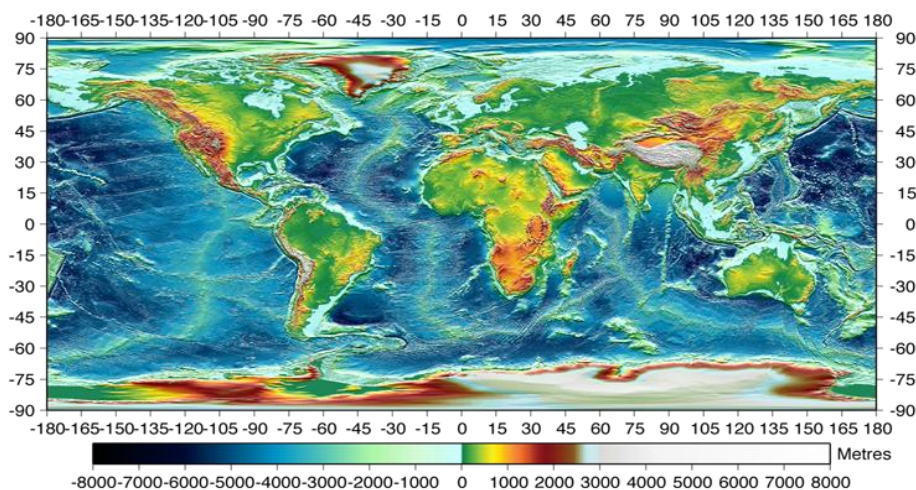

Figure 2-16: ACE2 Digital Terrain Model. (Credit: ESA/DMU)

For further information about applications related to land monitoring see: [ACE2 project](#) (ESA).

For further information about land applications and services available, see: [Copernicus](#) website.

2.2.5 Climate

The main application of SENTINEL-3 in relation to climate is in **determining mean sea level rise due to global warming**. As the ocean warms in response to global warming, sea waters expand and, as a result, sea level rises. When mountain glaciers melt in response to increasing air temperature, sea level rises because more freshwater glacial run-off discharges into the oceans. Similarly, ice mass loss from the ice sheets causes sea level to rise. The increased amount of freshwater flowing into the oceans reduces salinity, decreasing density and affecting ocean circulation patterns, which in turn affects sea level spatial variability.

The global mean level of the oceans is an indicator of climate change. It incorporates the reactions from several different components of the climate system. Precise monitoring of changes in the mean level of the oceans is vitally important for understanding not just the climate, but also the socio-economic consequences of any rise in sea level.

Mean sea level is an average, over all the oceans, of sea surface height, with respect to a reference. However, what is really sought, is the variation in this mean sea level over time.

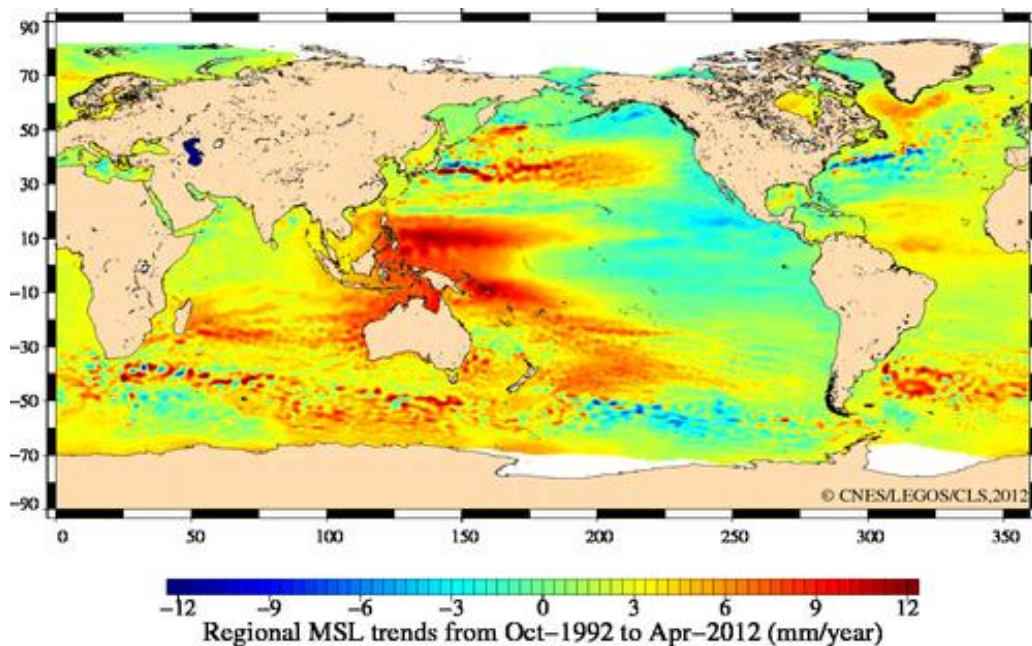

Figure 2-17: Regional Mean Sea Level Trends from October 1992 to April 2012 (Credit: CNES/LEGOS/CLS)

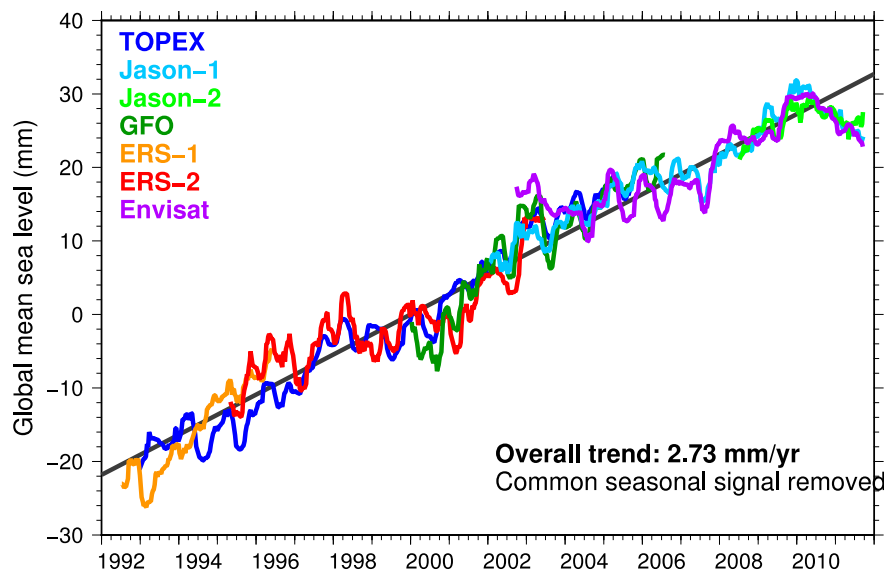

Figure 2-18: Global Mean Sea Level Trend from 1992 to 2012 Derived from SSH (Credit: Altimetrics LLC)

[Quicktime animation](#) - El Nino event March 2009 - February 2010. Cyclones have increased in the Pacific, whereas the 2009-2010 Atlantic hurricane season showed a decrease in events. El Nino, the ocean/climate phenomenon, is back. (Credit: MyOcean)

For further information about mean sea level rise see: ESA [CCI Sea Level](#) website.

For further information about climate change applications and services available, see: [Copernicus](#) website.

2.2.6 Geodesy and Geophysics

The SENTINEL-3 topography mission could be useful for the study of the Earth's shape and size, gravitational anomalies or sea floor relief.

Bathymetry

Satellite altimeter measurements, in combination with sparse measurements of sea floor depth, can be used to construct a uniform resolution map of the sea floor topography. These maps do not have sufficient accuracy and resolution to be used to assess navigational hazards but are useful for diverse applications such as locating obstructions or constrictions to the major ocean currents, and locating shallow seamounts where sea life is abundant.

Geodesy

Geodesy is the science of the Earth's shape and size. Altimetry makes it possible to compute Mean Sea Surface. Such a surface includes the geoid, i.e. the shape of the sea surface, assuming a complete absence of any perturbing forces (e.g. tides, winds, currents). The geoid reflects the Earth's gravitational field. It varies in height by as much as 100 m over distances of several thousand kilometres due to uneven mass distribution within the planet's crust, mantle and core. Other less pronounced irregularities are also visible over smaller distances. These mostly reflect the bathymetry (ocean bottom topography).

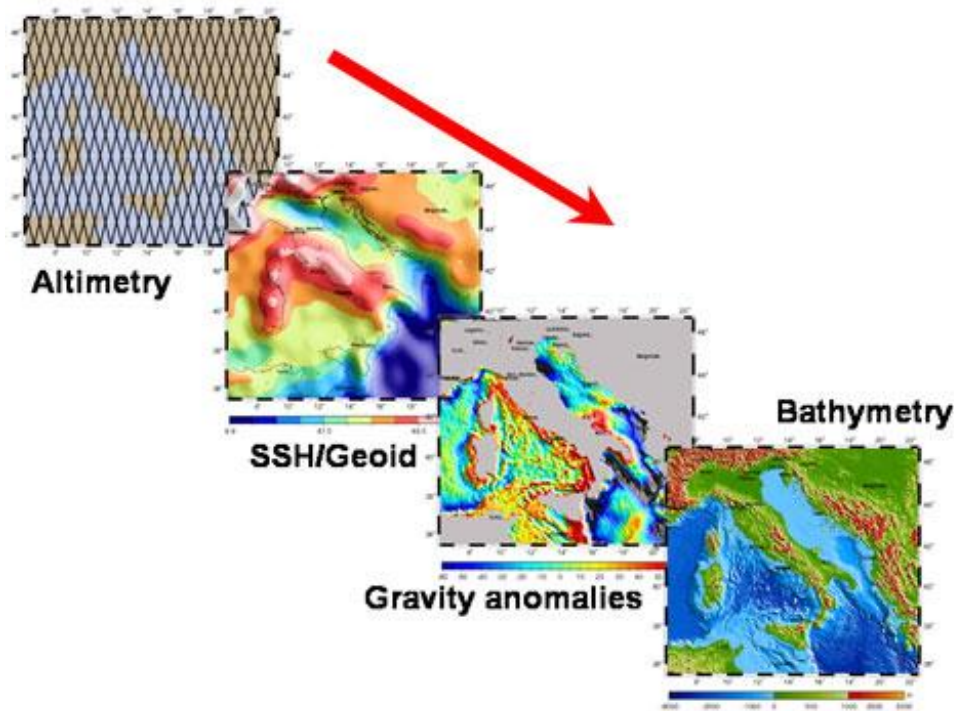

Figure 2-19: Geophysical Information Extracted from Altimetry (Credit: University of Calgary)

For further information about applications related to geodesy and geophysics see: [Radar Altimetry Tutorial](#) by ESA/CNES.

For further information about land applications and services available, see: [Copernicus](#) website.

2.3 Product Types

There are two types of Level-2 products according to the surface covered: water (WAT) and land (LAN) products, respectively, generate by the Marine Centre and the Land Centres. The processing baseline is identical at all processing centres. Only the geographical coverage is different.

The [Level-2 SRAL/MWR](#) complete product contains three files in netCDF format: one reduced data file, one standard data file and one enhanced data file.

The Sentinel-3 STM Level-1 and Level-2 NRT data products generated at the Core Ground Station (Svalbard) are today 10 minutes length, instead of being dump based, as originally specified. This is part of the new Product Definition. The Level-1 and Level-2 STC and NTC data products corresponds half orbit information (pole to pole).

There are three types of Level-1 products available to users: Level-1A products, Level-1B-S products and Level-1B products. Level-1A products contain geo-located bursts of echoes with all calibrations applied. Level-1B-S products contain fully SAR-processed and calibrated High Resolution complex echoes arranged in stacks after range correction and prior to echo multi-look. Level-1B products contain geo-located and fully calibrated multi-looked High Resolution power echoes.

SENTINEL-3 is the first Earth Observation altimetry mission to provide 100% SAR altimetry coverage where LRM is

maintained as a back-up operating mode.

For further information about SRAL/MWR Level-2 products see: [SENTINEL-3 Technical Guide](#).

2.3.1 Level-2 SRAL/MWR

A Level-2 SRAL/MWR complete product contains three files in netCDF format:

- one "reduced" (Red) data file, containing a subset of the main 1 Hz Ku band parameters
- one "standard" (Std) data file containing the standard 1 Hz and 20 Hz Ku and C-band parameters
- one "enhanced" (Enh) data file containing the standard 1 Hz and 20 Hz Ku and C-band parameters, the waveforms and the associated parameters necessary to reprocess the data (at least in LRM mode).

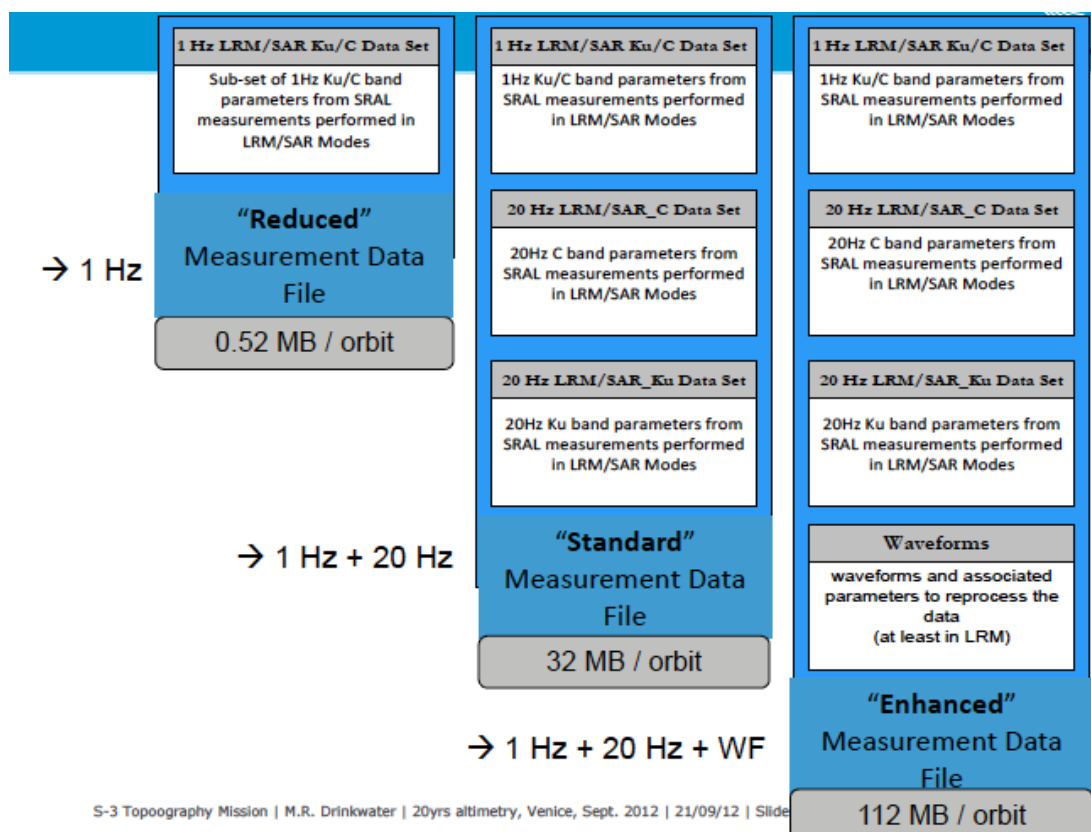

S-3 Topography Mission | M.R. Drinkwater | 20yrs altimetry, Venice, Sept. 2012 | 21/09/12 | Slide

Figure 2-20: Level-2 Product Types (Credit: ESA)

Each of these three files contains one or more data sets from among the following:

- "20-Hz LRM/SAR_Ku" data set: set of 20 Hz Ku-band parameters issued from SRAL tracking measurements performed in LRM and SAR modes
- "20-Hz LRM/SAR_C" data set: set of 20 Hz C-band parameters issued from SRAL tracking measurements performed in LRM and SAR modes
- "1-Hz LRM/SAR_Ku/C" data set: set of 1 Hz Ku/C-band parameters issued from SRAL tracking measurements performed in LRM and SAR modes.

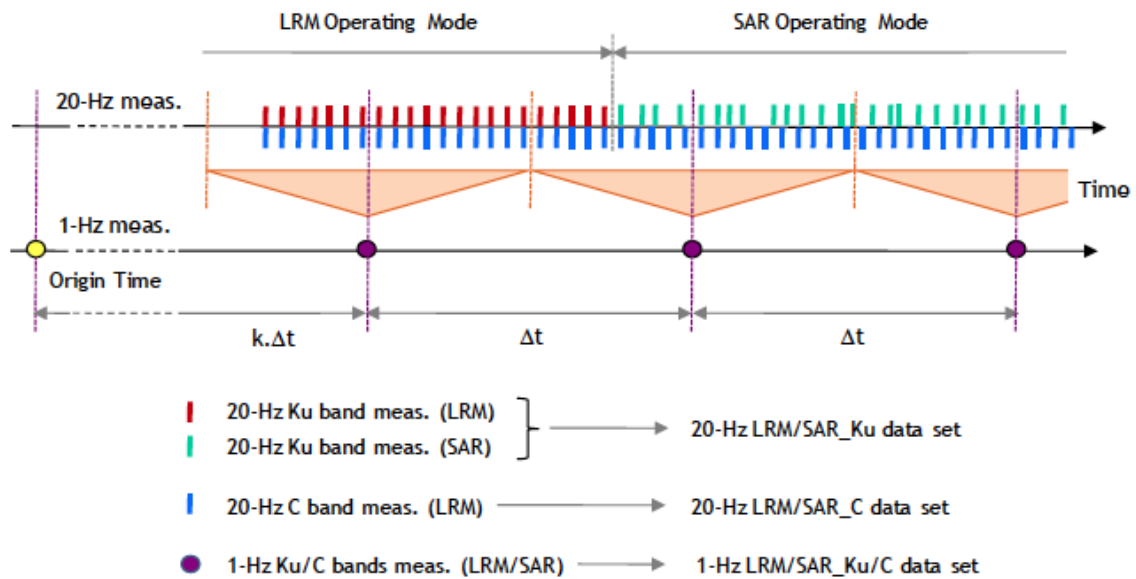

Figure 2-21: Level-2 Products Versus Operating Mode (LRM/SAR), Band (Ku/C) and Measurement Rhythm (1Hz/20Hz) (Credit: CLS)

2.3.2 Near Real-Time or Non Time Critical?

There are different data product types depending on delivery time to users and the available consolidated auxiliary or ancillary data.

- **Near Real-Time (NRT):** delivered less than 3 hours after data acquisition and mainly used for marine meteorology and ocean-atmosphere gas transfer studies (and possibly for operational oceanography depending on orbit accuracy).
- **Slow Time Critical (STC):** delivered within 48 hours after data acquisition, due mainly to the consolidation of some auxiliary or ancillary data (e.g. preliminary restituted orbit data) and the data are mainly used for geophysical studies and operational oceanography.
- **Non-Time Critical (NTC):** typically delivered within 1 month after data acquisition. This additional delay allows consolidation of some auxiliary or ancillary data (e.g. precise orbit data) and the data are mainly used for geophysical studies and operational oceanography.

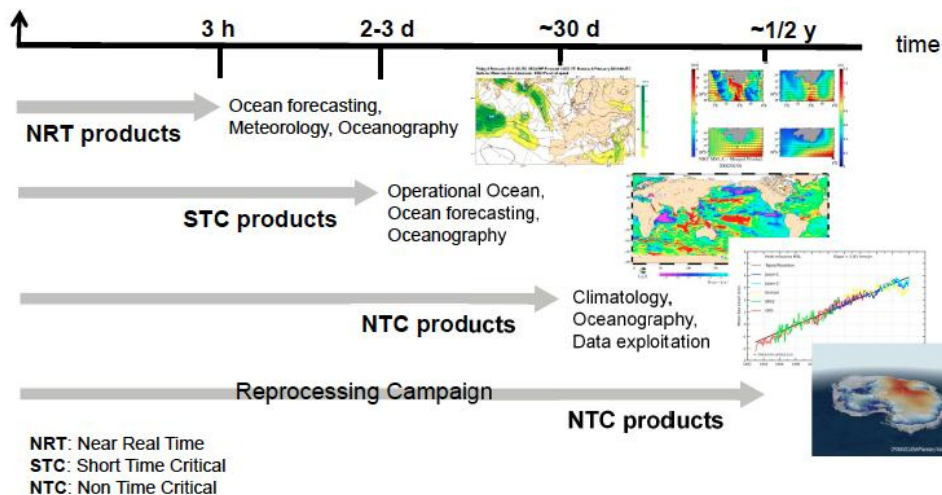

Figure 2-22: SRAL/MWR Level-2 Product Timeliness (Credit: ESA)

The selection of a product type in terms of delivery time (NRT, STC and NTC) is a trade-off between real-time needs and the final accuracy needed. Some Level-2 parameters depend on consolidating auxiliary and ancillary data such as orbit, platform or wet and dry tropospheric corrections.

2.4 Processing Levels

There are different data products associated with the three levels of processing of altimeter data:

- **Level-0** is the raw telemetered data, geolocated and dated
- **Level-1** is the Level-0 data corrected for instrumental and geometrical effects
- **Level-2** is the Level-1 data corrected for geophysical effects.

Level-0

The input data for [Level-0](#) processing is the Instrument Source Packet (ISP). The ISP contains raw data expressed in instrument engineering units, not in international system (SI) units. The first function of the Level-0 processing chain is to extract and decode the ISP raw data and convert it to SI units. The second function of the Level-0 processing chain is to correct the date and time of the measurements and to locate these measurements on the Earth (satellite position and measurement location on the Earth's surface).

Level-1

The input data for [Level-1](#) processing are the Level-0 products. The main function of the Level-1 processing chain is to calculate the tracker range, the sigma₀ scaling factor and the Level-1 waveforms, applying instrumental corrections to all of them. The Level-1 processing chain outputs three types of products: Level-1A, Level-1B-s and Level-1B products.

Level-2

The input data for [Level-2](#) processing are the Level-1 products. The first function of the Level-2 processing chain is to apply different re-tracking algorithms to the Level-1 waveforms to calculate the final altimeter range, backscatter coefficient, wind speed over ocean and SWH. There are different types of re-tracking algorithms according to the type of waveforms re-tracked (ocean, ice, sea-ice).

The Level-2 processing chain inputs are:

- one Level-1B SRAL product
- one Level-1B MWR product
- a set of dynamic ancillary or auxiliary data.

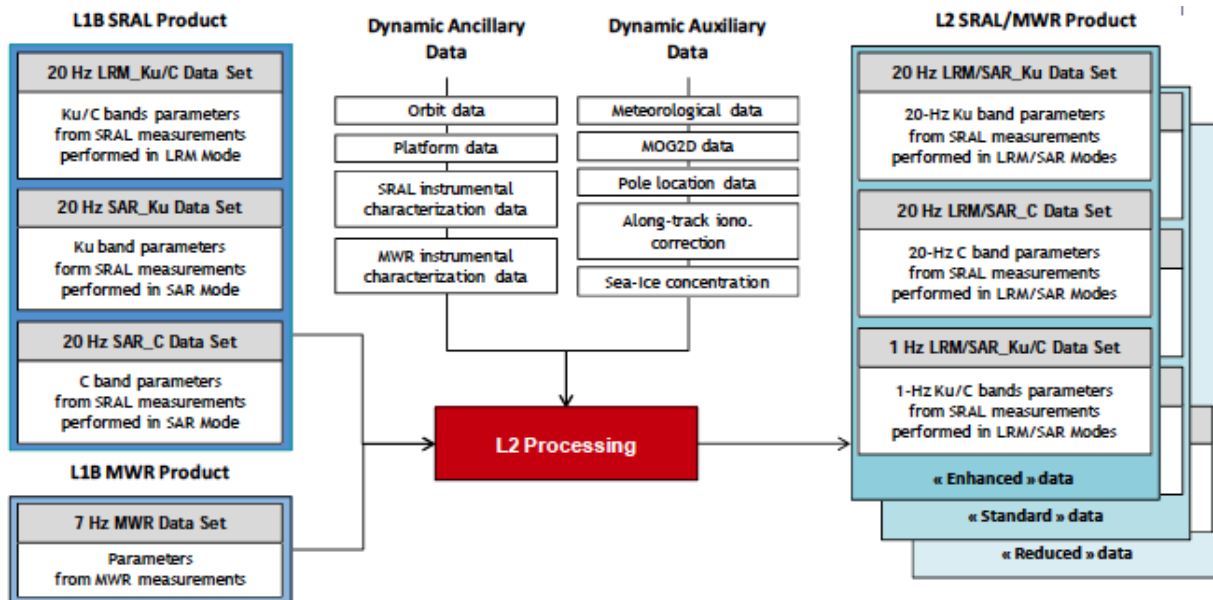

Figure 2-23: : SRAL and MWR Level-1B Inputs and SRAL/MWR Level-2 Outputs (Credit: CLS)

The second function of the Level-2 processing chain is to compute and apply all geophysical corrections to the measurements. Examples of geophysical corrections are the tides or the reference surface used (e.g. geoid).

2.4.1 Level-0

The Level-0 product is an output from Level-0 processing and is an internal product only. It is not available to users and is considered only as an input to Level-1 processing.

The satellite sends all data measured to the ground stations in the form of Instrument Source Packets (ISP). The data in ISPs are categorised and packaged according to their type:

- TM_ACQ: telemetry packets generated during acquisition mode
- TM_CAL1: telemetry packets generated during CAL1 calibration mode
- TM_CAL2: telemetry packets generated during CAL2 calibration mode
- TM_ECHO_LRM: telemetry packets generated during LRM tracking mode
- TM_ECHO_SAR: telemetry packets generated during SAR tracking mode.

2.4.2 Level-1

The Level-1 product is an output from Level-1 processing and is an internal product only. It is not available to users and is considered only as an input to Level-2 processing.

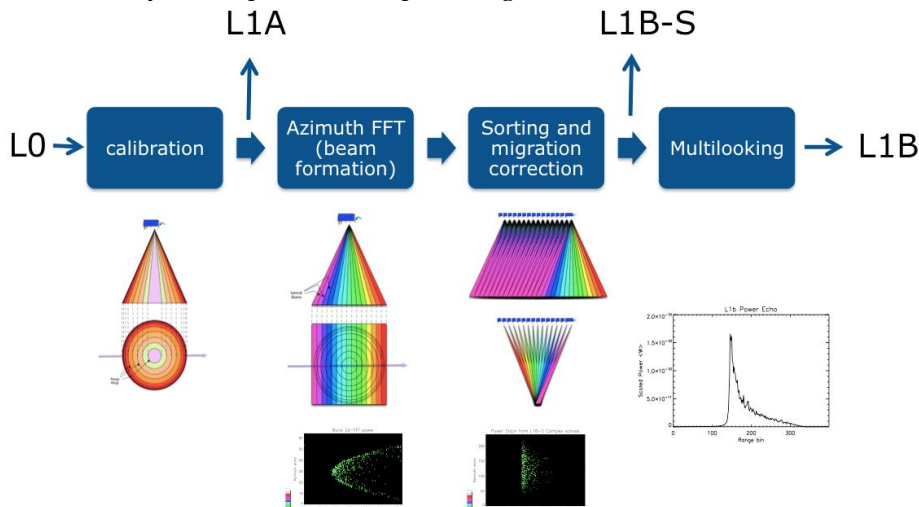

Figure 2-24: Level-1 High Resolution (SAR) Processing steps (Credit: ESA)

The Level-1 calibration chain computes all calibration corrections. One part of these calibration corrections is characterised on the ground and one part is measured in flight.

There are three types of calibrations:

- **calibration due to internal calibration of the instrument (CAL1)**
- **calibration due to the gain profile range window (CAL2)**
- calibration due to the calibration of the Automatic Gain Control (AGC) correction tables.

These calibration corrections are applied in the Level-1 measurement chains

There are two types of Level-1 processing measurement chains: one to process SAR-Ku band data SAR-C band data and another to process SAR-Ku band data. The main processing steps of the LRM and SAR-C Level-1 measurement chains are:

1. Determine surface type.
2. Correct tracker ranges for USO frequency drift.
3. Compute internal path correction.
4. Correct the AGC for instrumental errors.
5. Compute Sigma0 scaling factor.
6. Compute Doppler correction.
7. Correct waveforms by CAL2.

The main processing steps of the SAR-Ku Level-1 measurement chain are:

1. Determine surface type.
2. Correct tracker ranges for USO frequency drift.
3. Compute internal path correction.
4. Correct the AGC for instrumental errors.
5. Correct waveforms by CAL1 and CAL2.
6. Compute surface locations.
7. Apply Doppler correction.
8. Apply slant range correction.
9. Align the waveforms.

10. Perform the Doppler beams stack multi-looking.
11. Compute σ_0 scaling factor.

2.4.3 Level-2

There are three main steps in the Level-2 processing chain:

1. Compute time-derived geophysical/environmental parameters.
2. Perform re-tracking and compute physical parameters.
3. Compute Level-2 altimeter/radiometer geophysical processing.

Computing time-derived geophysical parameters involves:

- re-computing altitude, orbital altitude rate, location and Doppler correction, accounting for updated orbit data
- computing ionospheric corrections
- computing non-equilibrium and equilibrium ocean tide heights, tidal loading, solid earth tide height, equilibrium long period ocean tide height and pole tide height (using pole locations)
- computing the height of the mean sea surface above the reference ellipsoid
- computing the mean dynamic topography, the height of the geoid and the ocean depth/land elevation.

Performing retracking and computing physical parameters (LRM mode) involves:

- performing ocean re-tracking to waveforms, estimating waveform altimetric parameters such as epoch, composite sigma, amplitude or square of the mis-pointing angle
- computing 20 Hz altimeter range and backscatter coefficient
- computing 1 Hz estimates of the altimeter range, composite sigma, backscatter coefficients and square of the off-nadir angle (Ku-band only)
- computing 1 Hz physical parameters (SWH and modelled corrections for both bands) and correcting 1 Hz physical parameters.

Performing retracking and computing physical parameters (SAR mode) involves:

- discriminating echoes (ocean/lead, sea-ice, ice sheet margin or ocean/coastal)
- performing retracking (ocean/lead, sea-ice, ice sheet margin or ocean/coastal)
- computing physical parameters
- merging snow depth (ocean/lead and sea-ice only)
- performing a short-arc, along track ocean interpolation (ocean/lead and sea-ice only)
- estimating freeboards (ocean/lead and sea-ice only)
- performing a latitude limit check (ocean/lead and sea-ice only)
- performing modified slope correction (ice sheet margin and ocean/coastal only).

Level-2 altimeter/radiometer geophysical processing involves:

- inputting and checking Level-1 MWR products
- computing and correcting physical parameters according to platform data
- interpolating MWR data and computing MWR geophysical parameters
- computing altimeter wind speed and rain/ice flags
- computing wind, tropospheric corrections and inverted barometer according to meteorological data
- computing HF fluctuations of the sea surface topography
- computing sea state bias
- computing dual frequency ionospheric corrections
- building and checking Level-2 SRAL/MWR products.

2.5 Resolutions

Two radar modes are provided by the SRAL instrument.

In **SAR Mode**, patterns of 64 coherent Ku-band pulses are emitted in a burst (PRF of 18 kHz) surrounded by two C-band pulses. The burst cycle duration is approximately 12.5 ms so that a four-burst cycle is equal to the LRM cycle of 50 ms. The echo received from each pulse is sampled on 128 complex points. SAR processing on-ground then enhances the azimuth (along-track) resolution of the altimeter for each burst of pulses.

In **Low Resolution Mode (LRM)**, SRAL operates as a conventional pulse-limited altimeter with regular transmitting and receiving sequences, at a Pulse Repetition Frequency (PRF) of 1 920 Hz. Patterns of six Ku-band pulses surrounded by one C-band pulse, are used to ensure ionospheric bias correction. The echo received from each pulse is sampled on 128 points corresponding to a 60 m range window. C and Ku-band echoes are accumulated separately over a 50 ms cycle of the radar cycle (i.e. 84 Ku-band pulses and 14 C-band pulses accumulated over that cycle). Further ground processing produces 20 Hz Ku-band and C-band waveforms and the associated parameters for user applications.

The main difference between LRM and Nadir SAR mode, is that the Ku-band pulses within a burst are correlated, due to the selection of a high PRF and the phase coherence from pulses.

SENTINEL-3 will be the first Earth Observation altimetry mission to provide 100% SAR altimetry coverage where LRM is maintained as a back-up operating mode.

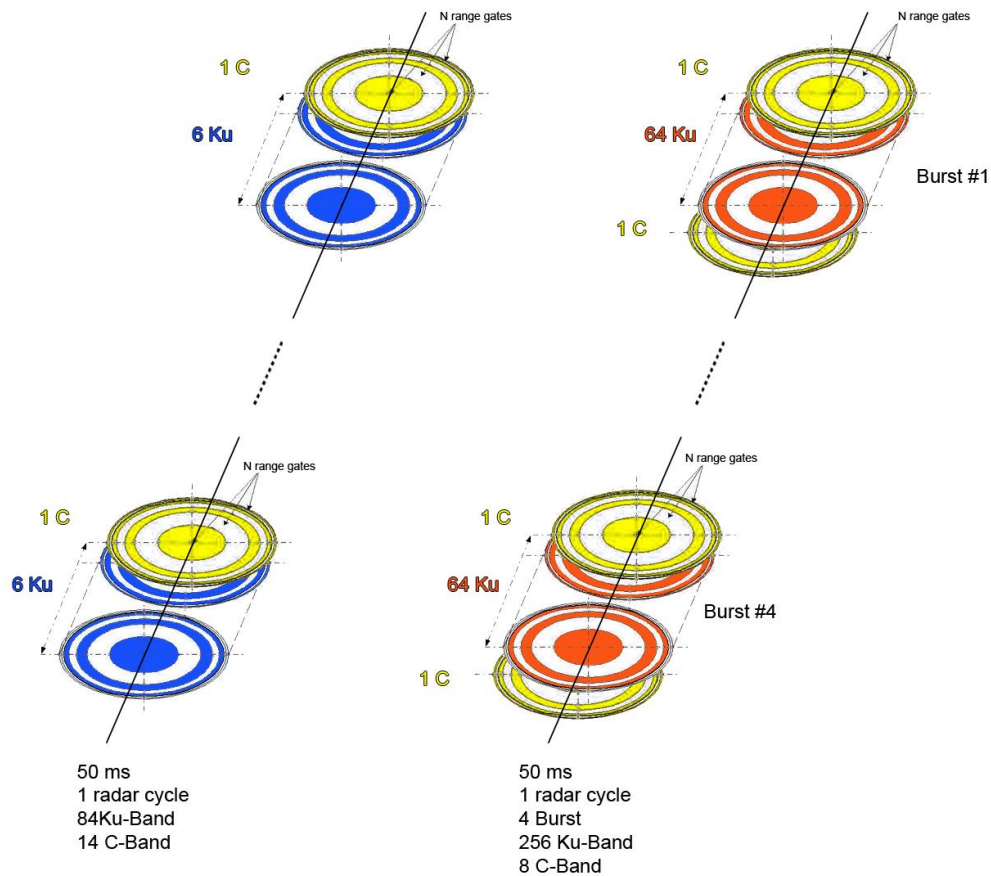

Figure 2-25: LRM radar cycle transmitting pattern (left) and SAR radar cycle transmitting pattern (right) LRM radar cycles contain 96 pulses (84 Ku-band and 14 C-band) structured in transmitting sequences of 1 C - 6 Ku pulses. SAR radar cycles contain four bursts, each of these bursts structured in transmitting sequences of 1 C - 64 Ku - 1 C pulses. (Credit: Thales Alenia Spazio).

2.5.1 Sampling

The spatial sampling of the altimeter measurements can be divided into two dimensions. The **along track sampling** is the along track distance between two measurements. The **range sampling** is the distance between two samples within a waveform.

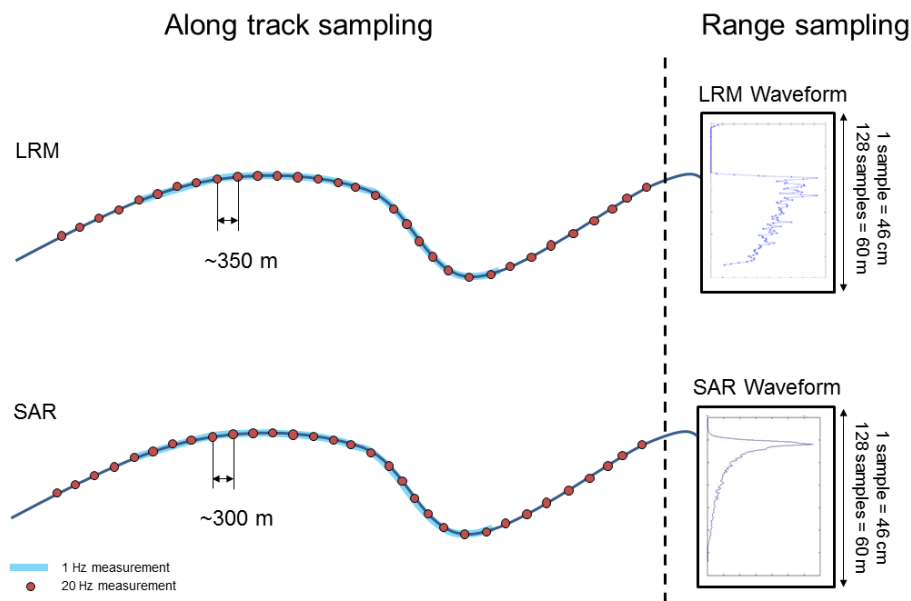

Figure 2-26: LRM and SAR Along Track Sampling at 1 Hz and 20 Hz Measurement Rate (left) and Range Sampling (right) (Credit: Thales Alenia Spazio)

To facilitate autonomous operations, LRM and SAR modes use one of two on-board tracking modes. Traditional, autonomous, closed-loop tracking of range and gain may be used where the altimeter range window is autonomously positioned based on on-board NRT analysis of previous SRAL waveforms.

Alternatively, an open-loop tracking mode is available where the altimeter range window is positioned using a priori knowledge of the surface height, stored on-board the instrument in a one-dimensional along track Digital Elevation Model (DEM). This mode facilitates acquisition over rough terrain and ensures continuous acquisitions across sea/land and sea/ice transition zones. A key advantage of open-loop tracking is that the data loss, typical of conventional closed-loop tracking due to mode switching, and loss of track during transitions or over variable terrain, are minimised.

2.5.2 Resolution Cells

LRM	SAR
Each emitted pulse is reflected by the surface and is returned to the altimeter a few milliseconds later. As the illuminated area grows, the return signal strength grows rapidly until an annulus is formed. It then remains constant until the growing annulus (or ring) reaches the edge of the radar antenna beam, and then starts to diminish.	The signal acquired by the altimeter at each Ku-band burst is initially the same as in LRM. It is made up of a series of 64 elementary range measurements that correspond to ground resolution cells (i.e. concentric rings).

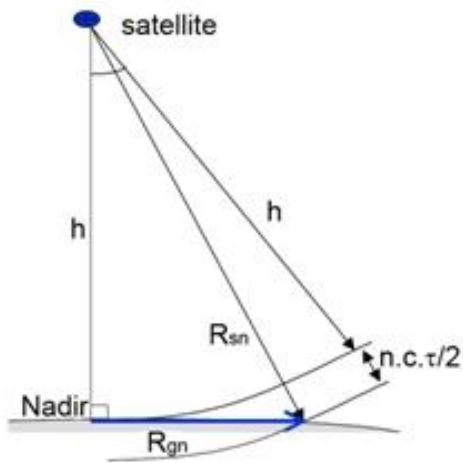

Figure 2-27: LRM Footprint (Credit: TAS-F)

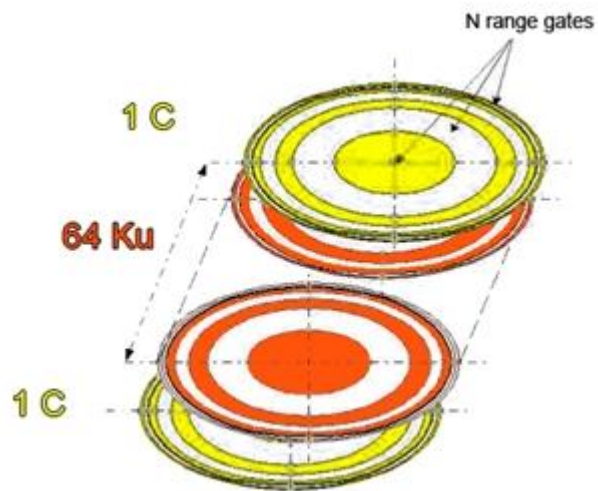

Figure 2-28: LRM Resolution Cell (Credit: TAS-F)

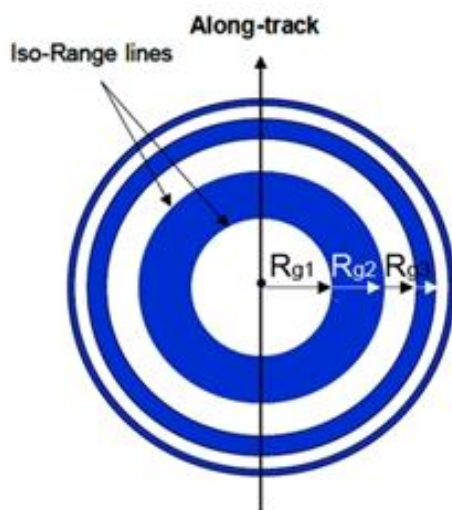

Figure 2-29: SAR Range Gates (Credit: TAS-F)

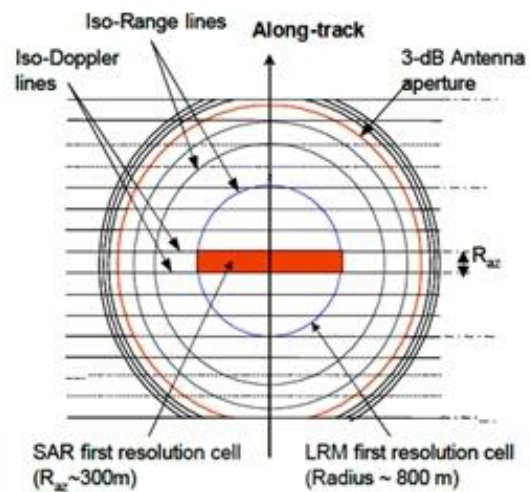

Figure 2-30: SAR Resolution Cell (Credit: TAS-F)

LRM along track resolution $\approx 1,6$ km
 LRM across track resolution $\approx 1,6$ km

SAR along track resolution ≈ 300 m
 SAR across track resolution $\approx 1,64$ km

2.6 Coverage

The choice of orbit for SENTINEL-3 is a compromise between the requirements of the topography mission and those of the optical mission. The SENTINEL-3 topography mission, as a single altimeter mission, cannot address these requirements alone and must consider other altimeter systems "in constellation" where synergy provides optimum spatial sampling, cross-calibration and reference altimetry. An example of synergy missions with the SENTINEL-3 mission is the entire JASON series of missions (JASON-2, JASON-3, JASON-CS) with a reference orbit in a low-inclination (66°).

It is appropriate for SENTINEL-3 to maintain an ENVISAT-type high-inclination polar orbit. This choice provides optimal SRAL coverage of the ocean, ice surfaces in high latitudes and of the European shelf seas that is fully in line with GMES recommendations.

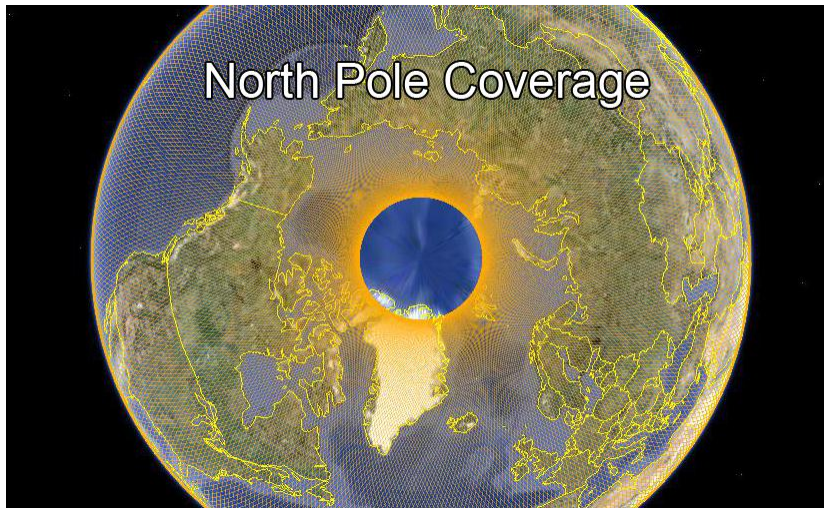

Figure 2-31: SENTINEL-3 Mission North Pole Coverage (Credit: isardSAT)

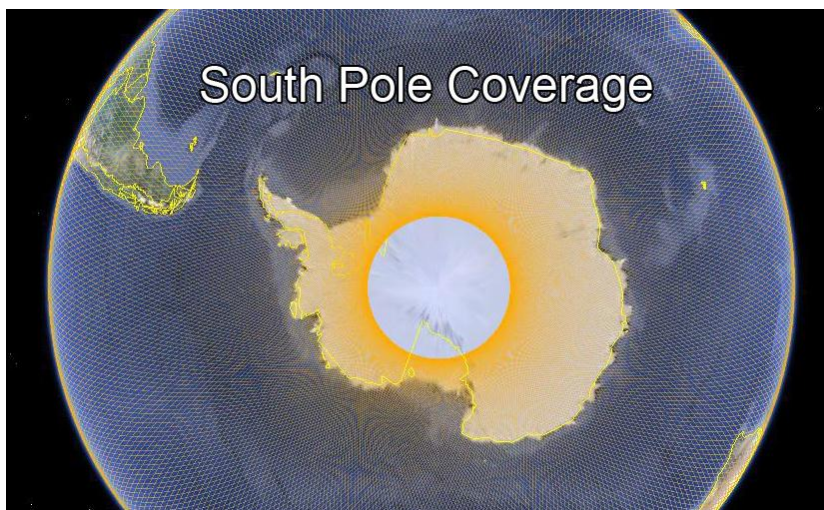

Figure 2-32: SENTINEL-3 Mission South Pole Coverage (Credit: isardSAT)

The configuration of two SENTINEL-3 satellites in constellation provides a 180° in-plane separation between the two spacecraft, driven by optical ocean and land coverage requirements. With the launch of SENTINEL-3B, the repeat cycle will be the same but the SRAL coverage will be increased.

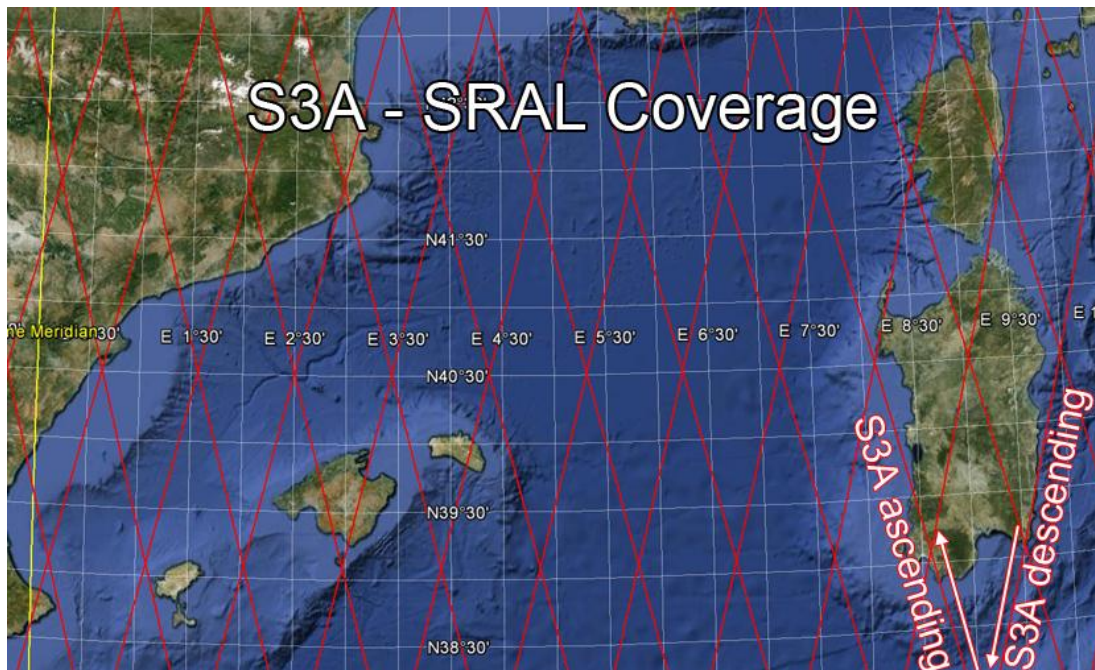

Figure 2-33: SENTINEL-3A Satellite Coverage Over the Balearic Islands in the Mediterranean Sea (Credit: isardSAT)

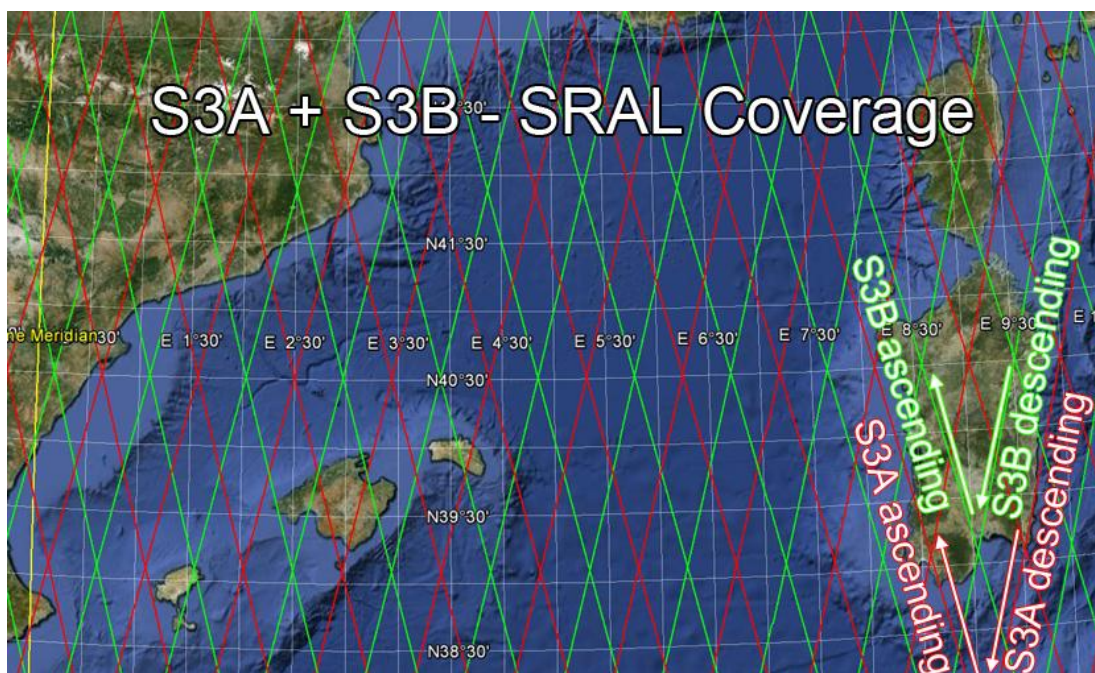

Figure 2-34: SENTINEL-3A (red) and SENTINEL-3B (green) Constellation Satellite Coverage (Credit: isardSAT)

In a two-satellite configuration, after one complete cycle, the inter-track separation is reduced from 104 km to 52 km at the equator.

For further information about orbit coverage, visit the [ESO](http://www.eso.int) website.

2.6.1 Orbit Characteristics

The SENTINEL-3 orbit is almost the same orbit as ENVISAT, allowing continuation of the ERS/ENVISAT and CRYOSAT time series.

The main parameters for the reference orbit are:

- type: near-polar frozen sun-synchronous
- inclination: 98.65°
- mean local solar time at descending node: 10:00 h
- repeat cycle: 27 days (14 + 7 / 27)
- reference altitude: 814.5 km
- cycle length: 385 orbits
- ground track separation at the Equator: 104 km with SENTINEL-3A, and 52 km with SENTINEL-3A and SENTINEL-3B.

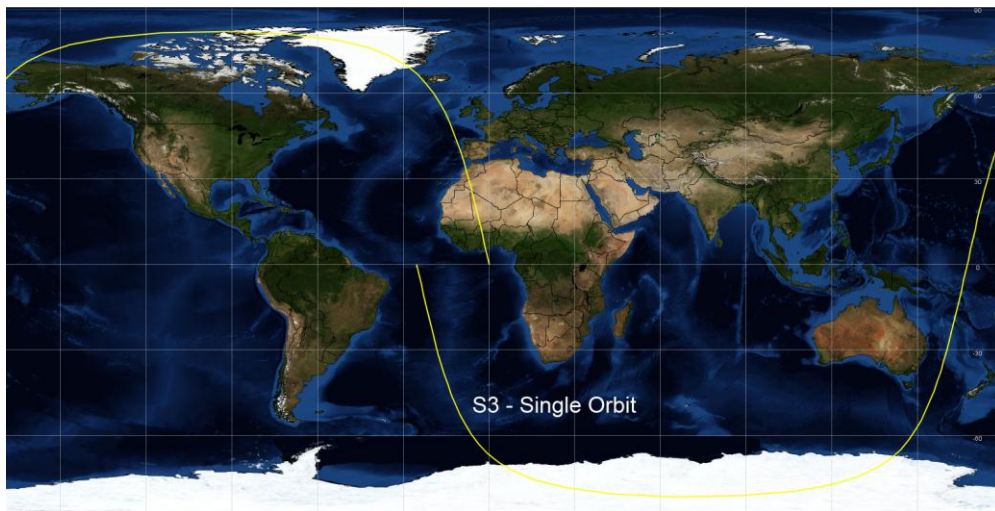

Figure 2-35: Example of SENTINEL-3 Single Orbit Ground Track (Credit: isardSAT)

The mean local solar time at descending node at 10:00h still provides complementary local time coverage while optimising the viewing conditions for the imager and allowing continuity with the existing ERS and ENVISAT climate products.

Having a high inclination provides important extra information about sea level variations in high latitudes not properly sampled before by a TOPEX type altimeter.

2.6.2 Revisit Time

The SENTINEL-3 orbit has a revisit time of 27 days providing global coverage of topography data at mesoscale (inter-track distance at the Equator 104 km using one satellite), with a primary orbit sub-cycle of approximately 4 days, as

described in Table 1. In a two-satellite configuration, after one complete cycle, the inter-track separation is reduced to 52 km at the Equator.

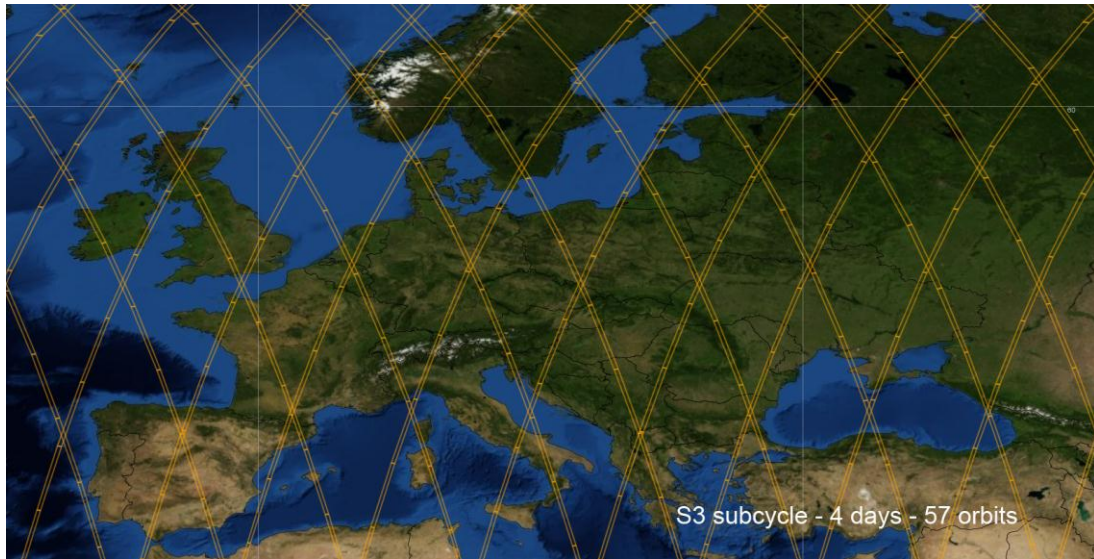

Figure 2-36: SENTINEL-3 Subcycle - 4 days - 57 orbits. Europe Map (Credit: isardSAT)

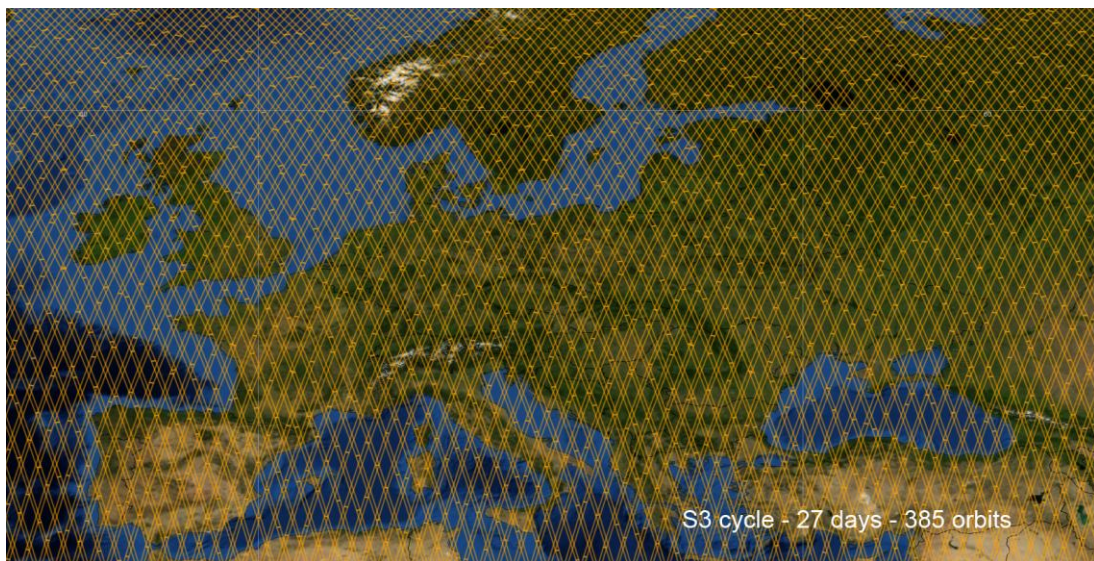

Figure 2-37: SENTINEL-3 Subcycle - 27 days - 385 orbits. Europe Map (Credit: isardSAT)

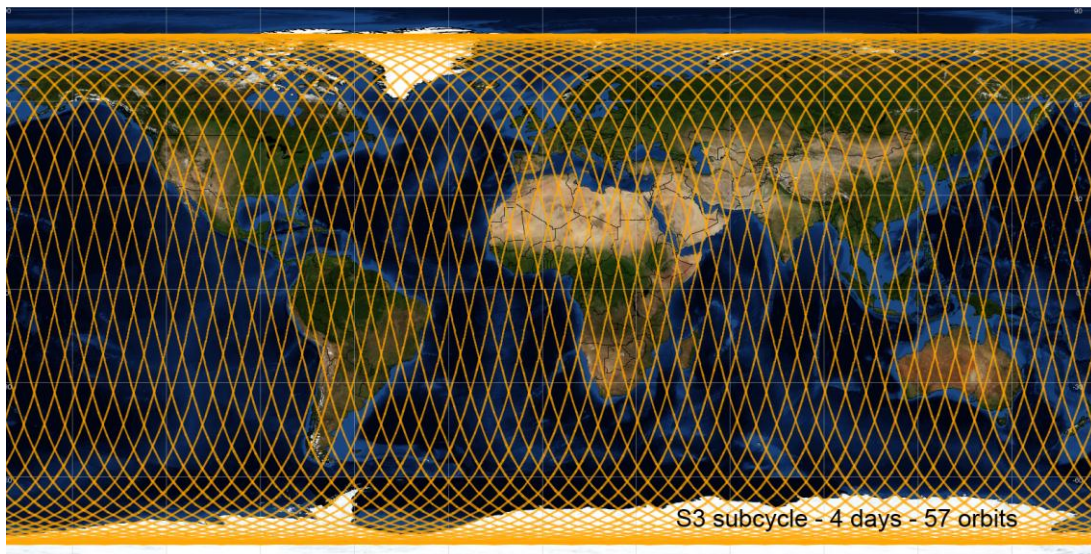

Figure 2-38: SENTINEL-3 Subcycle - 4 days - 57 orbits. World Map (Credit: isardSAT)

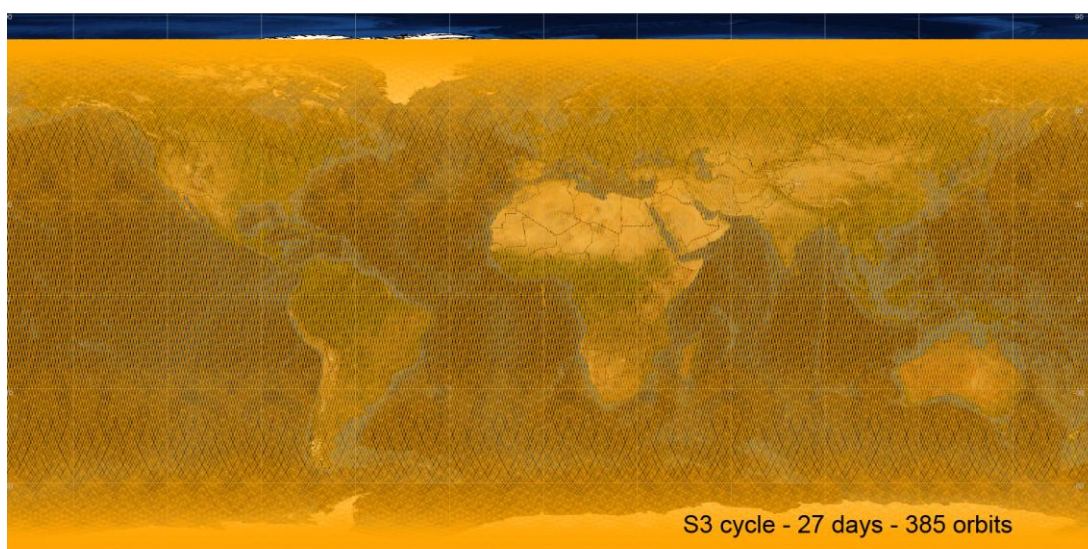

Figure 2-39: SENTINEL-3 Subcycle - 27 days - 385 orbits. World Map (Credit: isardSAT)

Constellation	Ground track separation at Equator	
	4 days	27 days
SENTINEL-3A	min= 104 km max= 728 km	104 km
SENTINEL-3A and B	min= 57 km max= 671 km	52 km

Table 2-3: Ground track separation at the Equator

2.7 Naming Conventions

The SRAL/MWR Level-2 product file name ([see this document for more details](#)) is defined according to the following convention:

MMM_SS_L_TTTTTT_yyyymmddThhmmss_YYYYMMDDTHHMMSS_YYYYMMDDTHHMMSS_<instance ID>_GGG_<class id>.<extension>

- **MMM:** mission ID: (e.g. S3A for SENTINEL-3A mission, S3B for SENTINEL-3B mission, S3_ for both SENTINEL-3A and SENTINEL-3B missions).
- **SS:** data source for the instrument data (e.g. SR for SRAL, DO for DORIS, MW for MWR and GN for GNSS) or the data consumer of the auxiliary data (e.g. AX for multi instrument auxiliary data).
- **L:** processing level: one digit or one underscore "_" (e.g.: "2" for Level-2 products, "1" for Level-1 products, "0" for Level-0 products or underscore "_" if processing level is not applicable.).
- **TTTTTT:** data type ID:
 - Level2 SRAL data: "LAN____" for Land products and "WAT____" for water products.
 - Level 1 SRAL data: "SRA____" for LRM, SAR Ku and SAR C L1B products, "SRA_A_" for LRM, SAR Ku and SAR C L1A products, "SRA_BS" for LRM, SAR Ku and SAR C L1B-S products and "CAL____" for calibration products
 - The last 2 digits suffix indicates "AX" for an auxiliary data and "BW" for a browse product.
- **yyymmddThhmmss:** Data Start time.
- **YYYYMMDDTHHMMSS:** Data Stop time.
- **YYYYMMDDTHHMMSS** is the creation date of the product
- **<instance ID>:** DDD_CCC_LLL_____, either upper-case letters or digits or underscores "_".
 - DDDD: orbit duration sensing data time interval in seconds.
 - CCC: cycle number at the start sensing time of the product
 - LLL: relative orbit number within the cycle at the start sensing time of the product
 - 4 underscores "_"
- **GGG:** product generating centre: three characters (e.g. "LN3" for Land Surface Topography Mission Processing and Archiving Centre and "MAR" for Marine Processing and Archiving Centre).
- **<class id>:** platform, eight characters, either upper-case letters or digits or underscores: P_XX_NNN, where:
 - P = one upper-case letter indicating the platform (e.g. O for operational, F for reference, D for development, R for reprocessing or one underscore "_" if not relevant).
 - XX = two upper-case letters/digits indicating the timeliness of the processing workflow (e.g. NR for NRT, ST for STC, NT for NTC or two underscores "_" if not relevant).
 - NNN: three letters/digits. Free text for indicating the baseline collection (001, 002,...) or data usage(e.g. test, GSV, etc) or three underscores "_" if not relevant.
- **<extension>:** the adopted filename extension is "SEN3"

Examples of filenames:

- S3A_SR_2_WAT____20150101T102500_20150101T114000_20150101T115000_4500_050_215____MAR_O_ST_002.SEN3
- S3A_SR_2_LAN____20150101T102500_20150101T114000_20150101T115000_4500_050_215____LN3_O_ST_003.SEN3
- S3A_SR_1_SRA____20150101T102500_20150101T114000_20150101T115000_4500_030_215____SVL_O_NR_001.SEN3
- S3A_SR_1_CAL____20150101T102500_20150101T114000_20150101T115000_4500_030_215____MAR_O_NR_001.SEN3

2.8 Data Formats & Size

SENTINEL data products are distributed using a **SENTINEL-specific variation of the Standard Archive Format for Europe (SAFE) format specification**. All the information relevant to the product is gathered into a single package. Inside this package, the specific objects containing measurement data are encoded in netCDF format.

The SENTINEL-SAFE format has been designed to act as a common format for archiving and conveying data within ESA Earth Observation archiving facilities.

SENTINEL-SAFE is based on the XML Formatted Data Units (XFDU) standard under development by the Consultative Committee for Space Data Systems (CCSDS). SENTINEL-SAFE is a profile of XFDU, and it restricts the XFDU specifications for specific utilisation in the EO domain, providing semantics in the same domain to improve interoperability between ground segment facilities.

The sizes of SRAL/MWR products (Level-1, Level-2 WAT and Level-2 LAN) are based on a duty cycle with 100% SAR mode. An orbit represents a time span of two consecutive crossings of the Ascending Node (ANX). For SENTINEL-3 it equates to $\approx 6\ 060$ seconds.

The sizes of L1 SRAL products are:

- Level-1A product: 17.5 GB/orbit
- Level-1B-S product: 18.1 GB/orbit
- Level--1B product: 290MB/orbit

The sizes of Level-2 WAT products are:

- Reduced file: 1.7 MB/orbit
- Standard file: 46 MB/orbit
- Enhanced file: 250 MB/orbit

The sizes of Level-2 LAN products are:

- Reduced file: 0.740 MB/orbit
- Standard file: 43 MB/orbit
- Enhanced file: 240 MB/orbit

2.8.1 SAFE Logical Model

Using the SENTINEL-SAFE format, information can be categorised in two main categories:

- data: the information contained in the product which causes the existence of the product itself
- metadata: stored information which is not data.

SENTINEL-SAFE is designed to manage any kind of data and data can be contained in a single file or in multiple files.

The model of a SAFE product is a logical tree of "content units" forming an "information package map".

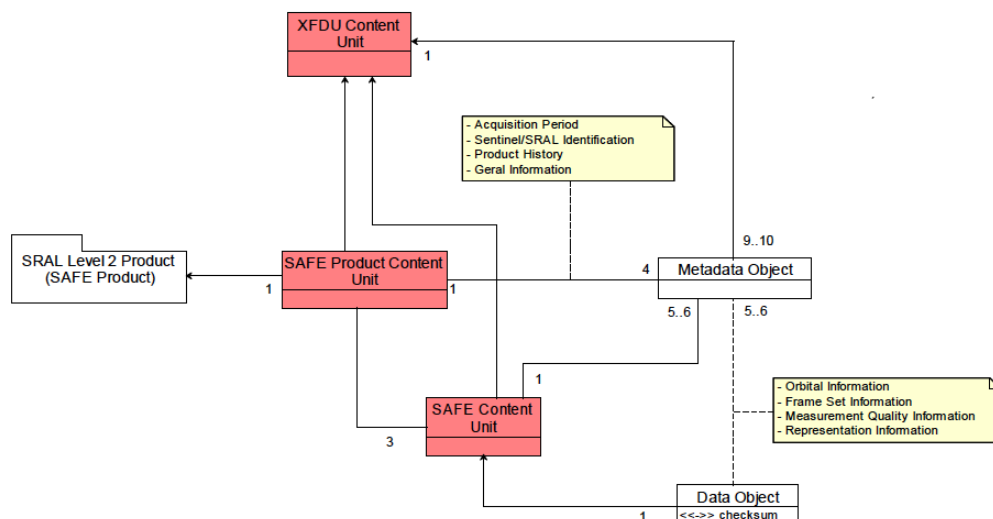

Figure 2-40: : Logical model - SRAL/MWR Level-2 Product (Credit: CLS)

The root content unit has predefined associations to the information applicable to the overall product, i.e. at least the "acquisition period", the "platform/sensor identification" and the "product history".

The structure of child content units is less constrained and depends mainly on the logical structure of the wrapped data. In most cases, one content unit matches one EO dataset and its accompanying metadata. Several content units may, however, share the same metadata.

2.8.2 SAFE Components

A SENTINEL-SAFE format product contains the following components:

- Manifest file: an XML document conforming to the XFDU manifest file specifications. It contains the definition of the information package map, wrapped metadata objects, wrapped data objects and references to the files containing the metadata and data objects.
- Binary or XML files: the data or metadata object contents. Currently, in the SAFE core specifications, only two types of files have been identified, i.e. binary matching MIME octet stream definition and XML documents.
- XML schema files: the representation information of the data held by a SAFE format product. To represent the binary information, the SAFE format also defines specific mark-ups to annotate XML schema documents, providing information on the physical structure (SDF mark-ups).

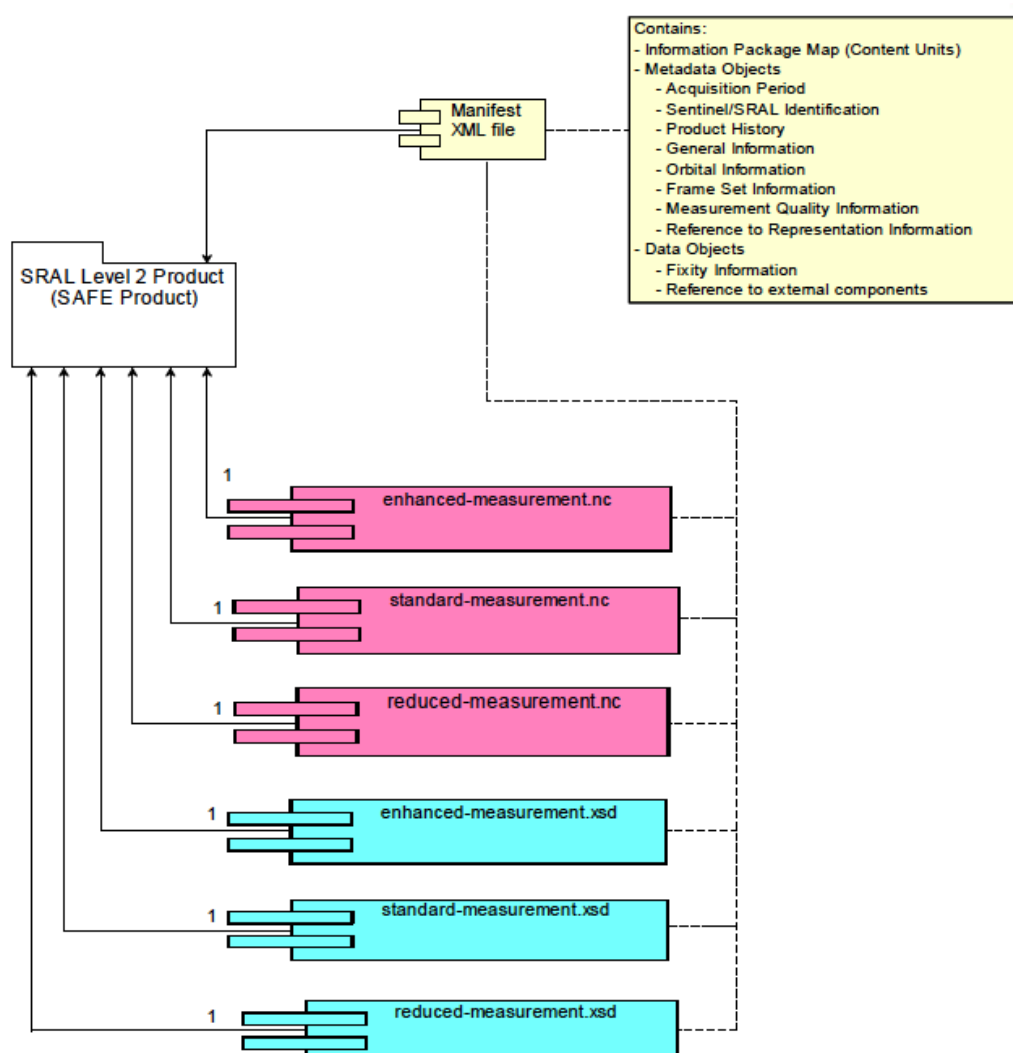

Figure 2-41: Physical Model - SRAL/MWR Level-2 Product (Credit: CLS)

A SRAL Level-2 product is composed of three main data objects (enhanced, standard and reduced) and their representation information:

- The measurement netCDF file enhanced-measurement.nc.
- The measurement representation information enhanced-measurement.xsd.
- The measurement netCDF file standard-measurement.nc.
- The measurement representation information standard-measurement.xsd.
- The measurement netCDF file reduced-measurement.nc.
- The measurement representation information reduced-measurement.xsd.

2.8.3 NetCDF Format

The netCDF format is extremely flexible and self-describing. It has been adopted as a de facto standard for many operational oceanography systems. The SRAL/MWR Level-2 product files will also follow the climate and forecast netCDF conventions CF-1.4.

A netCDF file contains dimensions, variables and attributes.

A dimension may be used to represent a real physical dimension (e.g. time, latitude, longitude, or height). A dimension might also be used to index other quantities (e.g. waveforms index).

Variables are used to store the bulk of the data in a netCDF file. A variable represents an array of values of the same type. A variable has a name, a data type and a shape described by its list of dimensions, specified when the variable is created. A variable may also have associated attributes, which may be added, deleted or changed after the variable is created.

NetCDF attributes are used to store information about the data (ancillary data or metadata). Most attributes provide information about a specific variable. These are identified by the name of the variable, together with the name of the attribute. Examples of attributes are units, scale factor, offset to be added and reference time calendar.

An example of a netCDF file:

```
netcdf example {
dimensions:
time = 2680; // dimensions name are declared first
variables:
double time(time); // variable [type] [name]([dimension])
time:long_name = "time"; // variable attributes
time:units = "seconds since 2000-01-01 00:00:00.0";
```

The Common Data Language (CDL) will be used to describe the content of a data set. The CDL is textual notation that describes the netCDF object and it is readable by a human. The netCDF utility 'ncdump' converts netCDF objects binary to CDL text. The netCDF utility 'ncgen' creates netCDF binary files from CDL text files.

2.9 Definitions

2.9.1 Units

Time

The units used in the SRAL/MWR Level-2 products are SI units, except for angles which use degrees as opposed to radians.

Quantity	Unit	Symbol
Length	meter	m
Mass	kilogram	kg
Time	second	s
Angle	degree	°
Frequency	Hertz	Hz

Table 2-4: SRAL/MWR Level-2 products units

The SRAL/MWR Level-2 product variables may have an offset and/or a scale factor applied in the netCDF output files to maintain maximum precision using an integer data type variable. They shall be considered when reading the values of these variables. An example is shown below for the altitude variable at 1 Hz:

```
int alt(time);
```

```
alt:long_name = "1 Hz altitude of satellite";
alt:_FillValue = 2147483647;
alt:units = "m";
alt:add_offset = 1.30e+06;
alt:scale_factor = 1.00e-04;
alt:coordinates = "lon lat";
```

The data are stored in 32-bit integers (long). The value of the altitude expressed in metres (SI) of the satellite can be recovered using:

```
alt_si = (alt * scale_factor) + add_offset
```

2.9.2 Conventions

Time

The time reference system in the SRAL/MWR Level-2 products is the Universal Time Coordinated (UTC). The UTC system is piecewise uniform and continuous, i.e. the time difference between UTC and TAI is equal to an integer number of seconds and is constant except for occasional jumps from inserted integer leap seconds. The leap seconds are inserted to cause UTC to follow the rotation of the Earth, which is expressed by means of the non-uniform time reference Universal Time UT1.

On-board, the time reference system is the Global Positioning System (GPS). GPS time is an atomic clock time similar to, but not identical to, UTC time. It is synchronised to UTC but the main difference is that GPS time does not introduce leap seconds. The introduction of UTC leap seconds causes GPS time and UTC time to differ by a known integer number of cumulative leap seconds, i.e. the leap seconds that have been accumulated since GPS epoch at midnight on January 5th 1980.

The conversion from GPS time to UTC time is implemented in the Level-1 processing chain.

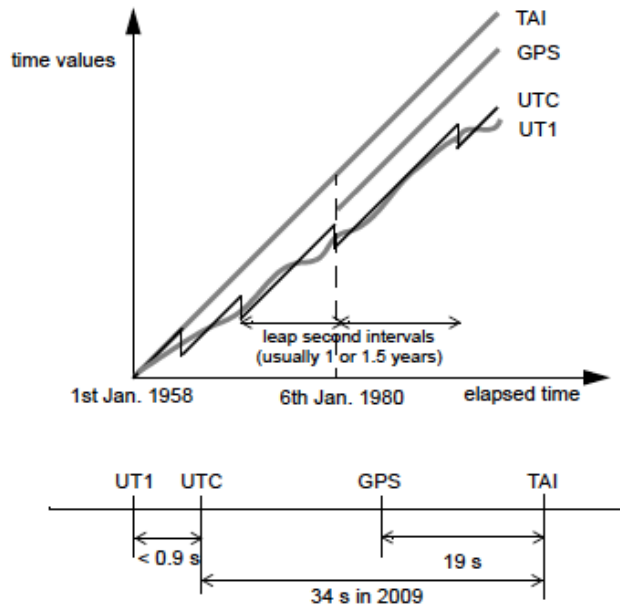

Figure 2-42: Relationship Between Time Reference Systems (Credit: DEIMOS)

The time format of SRAL/MWR products is Modified Julian Day 2000 (MJD2000): interval of time in days and fractions of days since January 1st 2000 at 00:00:00.

The time resolution is one microsecond.

Position Reference Frames

Earth fixed: the reference frame used for input and output of the satellite state vector (i.e. orbit definition), and for the output for geolocation. The Earth fixed reference frame in use is the IERS Terrestrial Reference Frame (ITRF).

Satellite Orbital: a reference frame centred on the satellite and is defined by the Xs, Ys and Zs axes, which are specified relatively to the reference inertial reference frame, namely the True of Date (TOD). The Zs axis points along the radial satellite direction vector, positive from the centre of the TOD reference frame towards the satellite. The Ys axis points along the transversal direction vector within the osculating orbital plane (i.e. the plane defined by the position and velocity vectors of the satellite), orthogonal to the Zs axis and opposed to the direction of the orbital motion of the satellite. The Xs axis points towards the out-of-plane direction vector completing the right hand reference frame.

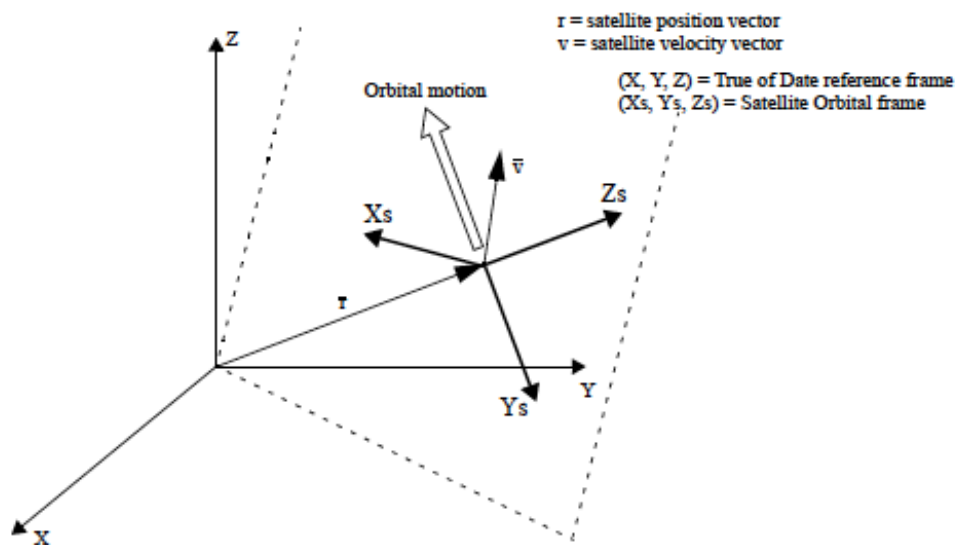

Figure 2-43: Satellite Orbital Frame (Credit: DEIMOS)

Reference ellipsoid: the geometry of the Earth is modelled by a reference ellipsoid. The reference ellipsoid model in the SENTINEL-3 mission is WGS84. The geodetic coordinates (longitude, latitude and altitude) of each point measurement are referenced to WGS84 reference ellipsoid.

2.9.3 Notations

Absolute Dynamic Topography: sea surface height with respect to the geoid.

Along track data: data chronologically ordered, following the satellite "ground track".

Altitude: distance from the satellite to the reference ellipsoid.

Ascending node: the ascending node of an orbit is the intersection of that orbit, when the satellite goes from the southern to the northern hemisphere, with the x-y plane of the Earth fixed reference frame.

Cycle: in geo/helio-synchronous orbits, the ground track repeats precisely after a constant integer number of orbits and a constant duration. The duration in days of that period is called the repeat cycle, whereas the corresponding number of orbits is called the cycle length.

Geoid: the shape of the sea surface assuming a complete absence of perturbing forces (tides, wind, currents, etc.). The geoid reflects the Earth's gravitational field.

Geophysical corrections: the radar pulse used to measure altimetry is subjected to a number of disturbances as it passes through the atmosphere and when it is reflected by the sea surface.

Ground track: the trace made by the sub-satellite point on the surface of the Earth's Reference Ellipsoid due to the motion of the satellite along its orbit.

Mean Sea Level: the sea surface height averaged across all the oceans of the globe. An increase in mean sea level is an indication of possible global warming.

Mean Sea Surface: a permanent component of sea surface height. The mean sea surface comprises a geoid contribution (approximately 100 m) and a permanent circulation contribution (approximately 1 m).

Orbit Number: the absolute orbit number considers the orbits elapsed since the first ascending node crossing after launch. The relative orbit number is a count of orbits from 1 to the number of orbits contained in a repeat cycle. The relative orbit number 1 corresponds to the orbit whose ascending node crossing is closest to the Greenwich Meridian (eastwards).

Range: distance from the satellite to the Earth's surface.

Reference ellipsoid: an arbitrary reference surface that is a raw approximation of the Earth's shape, which is basically a sphere "flattened" at its poles. The length of one of the axes at the Equator is chosen so that the ellipsoid coincides at this latitude with the mean sea level.

Satellite altimetry: a technique for measuring height. Satellite altimetry measures the time taken by a radar pulse to travel from the satellite antenna to the surface and back to the satellite receiver. Combined with precise satellite location data, altimetry measurements yield sea-surface heights.

Sigma o (or sigma-naught): backscatter coefficient of the radar wave on the surface.

Sea Level Anomaly: variations in the sea surface height with respect to mean sea level. SLAs include seasonal variability.

Sea State Bias: bias due to the sea-surface state, consisting of two components (electromagnetic bias and tracker bias).

Sea Surface Height: height of the sea surface with respect to a reference. In altimetry, usually the sea surface height with respect to the reference ellipsoid.

Significant Wave Height: average wave height (from trough to crest) of the highest third (33.33%) of the waves in a given sample period.

Sub-satellite Point: the normal projection of the position of the satellite in orbit on to the surface of the Earth's reference ellipsoid. It is also referred to as nadir.

Waveform: the magnitude and shape of the radar altimetry return echoes.

2.10 S3-ALT Document Library

[Sentinel-3A Product Notice - STM Level-2 Land NRT, STC and NTC](#)

This is a Product Notice for the public release of Sentinel-3 Surface Topography Mission (STM) Level-2 Land products at Near Real Time (NRT), Short Time Critical (STC) and Non Time Critical (NTC) timeliness. The notice describes the S-3A STM current status, processing baseline, product quality and limitations, and product availability status.

[Read more...](#) [PDF](#)

[Sentinel-3A Product Notice - STM Level-1 NRT and STC](#)

This is a Product Notice for the public release of Sentinel-3 Surface Topography Mission (STM) Level-1B products at Near Real Time (NRT) and Short Time Critical (STC) timeliness. The notice describes the Level-1B current status, processing baseline, product quality and limitations, and product availability status.

[Read more...](#) [PDF](#)

[GSC Sentinel-3 PDGS Products Definition](#)

This document is intended to provide the description of the Sentinel-3 products that will be generated within the Sentinel-3 Payload Data Ground Segment by the Sentinel-3 Instrument Processing Facilities (IPFs).

[Read more...](#) [PDF](#)

[Sentinel-3 Product Data Format Specification - SRAL/MWR Level 1 and 2 Instrument Products](#)

This document aims to identify and specify the format of the Sentinel-3 SRAL and MWR products for Level 1 and Level 2.

The Metadata Specification, as referenced in the product specification is available for [download](#).

[Read more...](#) [PDF](#)

[Sentinel-3 User Handbook](#)

The Sentinel-3 Mission Guide provides a high-level description of the mission objectives, satellite description and ground segment. It also covers an introduction to heritage missions, thematic areas and services, orbit characteristics and coverage, instrument payloads and data products.

[Read more...](#) [PDF](#)

[Sentinel-3 Product Data Format Specification - Product Structures](#)

This document aims to identify and specify the common definitions, structures and conventions of the Sentinel-3 products from Level 0 up to Level 2.

[Read more...](#) [PDF](#)

[Sentinel-3 Test Data Set Generation report for Level 2 SRAL/MWR IPF](#)

This document is a technical note describing the work performed in the framework of the AD 2 proposal, that is to say the generation of a Sentinel-3 Level 2 Test Data Set within the Sentinel-3 Core Payload Data Ground Segment Instrument Processing Facility Implementation project.

[Read more...](#) [PDF](#)

[Sentinel-3 PDGS File Naming Convention](#)

This Technical Note provides the File Naming Convention adopted by the Sentinel-3 PDGS for the following data classes:

- Instrument data products, including
 - Level-0 products
 - Higher level data products
- Auxiliary data

[Read more...](#) [PDF](#)

[Sentinel-3 SRAL/MWR Surface Topography Mission \(STM\) Level-2 ATBD](#)

This document is aimed at defining and specifying the "scientific" algorithms used in the Level-2 processing of the Sentinel-3 Surface Topography Mission SRAL and MWR data, which is defined in the L2 Processing Specification document (AD 10).

[Read more...](#) [PDF](#)

[Sentinels POD Product Handbook](#)

This document describes the Sentinels POD Product Handbook. It describes the products generated as part of the provisioning of the Sentinels POD Service. This includes the products generated at the Sentinels POD Service Centre itself, and, those generated by the Sentinel-3 POD Instrument Processing Facility running at the S-3 Core PDGS.

[Read more...](#) [PDF](#)

[Sentinels POD Service File Format Specifications](#)

The purpose of this document is to define the product structure and the content of each file generated and delivered by the POD Service Centre and the Sentinel-3 NRT POD Instrument Processing Facility (IPF) across its interfaces to the Sentinels (1, 2 and 3) Payload Data Ground Segments (PDGSs).

[Read more...](#) [PDF](#)

3 SENTINEL-3 OLCI USER GUIDE

3.1 Introduction

The SENTINEL-3 OLCI User Guide provides a high level description of the available instrument modes and products. It also provides an introduction to relevant application areas, information on data distribution, product formatting and software tools available from ESA.

The categories are:

- **[Overview](#)**
Gives a brief overview of the [OLCI heritage and new instrument features](#). This also describes the main characteristics in terms of [geophysical measurements](#).
- **[Applications](#)**
Describes the support of the SENTINEL-3 OLCI mission to [maritime monitoring](#), [land mapping and monitoring](#), [atmospheric monitoring](#) and [climate change monitoring](#).
- **[Product Types](#)**
Describes the granularity of SENTINEL-3 OLCI products distributed to the users: [Level-1B](#), [Level-2 land](#) and [Level-2 water](#).
- **[Processing Levels](#)**
Illustrates the processing steps from [Level-0](#), [Level-1](#) to [Level-2](#).
- **[Resolutions](#)** and **[Coverage](#)**
Defines the [spatial full or reduced resolutions](#), the [radiometric resolutions](#) and describes the revisit frequency and coverage.
- **[Naming Convention](#)** and **[Data Formats](#)**
Describes the data naming conventions used and introduces the formatting used for [Level-0](#), [Level-1](#) and [Level-2](#) products.
- **[Definitions](#)**
Provides information on the [units](#), [notations](#) and [product grids](#) used in the acquisition and processing of OLCI products.

For an in-depth description of the mission's products and algorithms, as well as details on the SAR instrument and its performance, please refer to the [SENTINEL-3 OLCI Technical Guide](#). The detailed information available in the Technical Guide is focused upon users such as academics and industrial software engineers who have previous experience of similar EO missions, and in-depth experience of data manipulation and management.

3.2 Overview

OLCI is an optical instrument used to provide data continuity for ENVISAT's MERIS. OLCI is a push-broom imaging spectrometer that measures solar radiation reflected by the Earth, at a ground [spatial resolution](#) of 300 m, in 21 spectral bands.

The [primary objective](#) of [OLCI products](#) is to screen the ocean and land surface to harvest information related to biology. OLCI also provides information on the atmosphere and contributes to climate study.

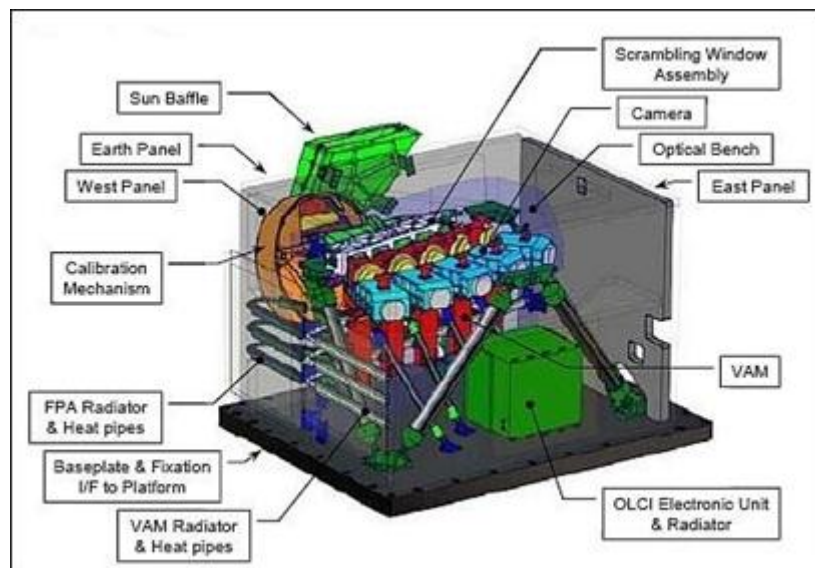

Figure 3-1: Schematic View of the OLCI Instrument

3.2.1 Heritage

Remote sensing of ocean colour from space began in 1978 with the launch of NASA's Coastal Zone Colour Scanner (CZCS). A number of other missions have been launched and more are planned by various space agencies. The International Ocean-Colour Coordinating Group ([IOCCG](#)) coordinates information relating to the various missions and instruments.

The key mission driver for the SENTINEL-3 OLCI instrument is continuity of the ENVISAT MERIS instrument capability.

The SENTINEL-3 [OLCI instrument](#) is based on the opto-mechanical and imaging design of ENVISAT MERIS. The instrument is a quasi-autonomous, self-contained, visible push-broom imaging spectrometer and incorporates the following significant improvements when compared to MERIS:

- an increase in the number of spectral bands (from 15 to 21)
- improved SNR through the use of a 14-bit analogue to digital converter
- improved long-term radiometric stability
- mitigation of sun-glint contamination by tilting cameras in a westerly direction
- complete coverage over both land and ocean at 300 m full resolution (for MERIS the reduced resolution was on-board computed)
- improved instrument characterisation including stray light, camera overlap and calibration diffusers
- improved coverage of the global ocean (<4 days), land (<3 days with one satellite, ignoring the effect of clouds), where MERIS is approximately 15 days
- improved data delivery time of 3 hours for Level-1B and Level-2 products
- 100% overlap with [SLSTR](#) instrument swath and simultaneous acquisitions facilitating the use of OLCI and SLSTR in synergy.

OLCI bands are optimised to measure ocean colour over open ocean and coastal zones. A new channel at 1.02 μm has been included to improve atmospheric and aerosol correction capabilities. Two additional channels in the O_2A absorption line (764.4 and 767.5 nm, in addition to the existing channel at 761.25 nm) are included for

improved cloud top pressure (height) with an additional channel at 940 nm in the H₂O absorption region, to improve water vapour retrieval. A channel at 673 nm has been added for improved chlorophyll fluorescence measurement.

The OLCI swath is not centred at nadir (as in the MERIS design) but the whole field-of-view is shifted across track by 12.6° away from the sun to minimise the impact of sun glint (sun glint contamination affects more than half of the MERIS observations at sub-tropical latitudes). In addition, the OLCI instrument is mounted on the satellite to allow a direct view of the Earth, removing the need for an additional fold mirror as used by MERIS.

Band #	λ center	Width	Lmin	Lref	Lsat	SNR@Lref
	nm		W/(m ² .sr.μm)	W/(m ² .sr.μm)	W/(m ² .sr.μm)	
Oa1	400	15	21.60	62.95	413.5	2188
Oa2	412.5	10	25.93	74.14	501.3	2061
Oa3	442.5	10	23.96	65.61	466.1	1811
Oa4	490	10	19.78	51.21	483.3	1541
Oa5	510	10	17.45	44.39	449.6	1488
Oa6	560	10	12.73	31.49	524.5	1280
Oa7	620	10	8.86	21.14	397.9	997
Oa8	665	10	7.12	16.38	364.9	883
Oa9	673.75	7.5	6.87	15.70	443.1	707
Oa10	681.25	7.5	6.65	15.11	350.3	745
Oa11	708.75	10	5.66	12.73	332.4	785
Oa12	753.75	7.5	4.70	10.33	377.7	605
Oa13	761.25	2.5	2.53	6.09	369.5	232
Oa14	764.375	3.75	3.00	7.13	373.4	305
Oa15	767.5	2.5	3.27	7.58	250.0	330
Oa16	778.75	15	4.22	9.18	277.5	812
Oa17	865	20	2.88	6.17	229.5	666
Oa18	885	10	2.80	6.00	281.0	395
Oa19	900	10	2.05	4.73	237.6	308
Oa20	940	20	0.94	2.39	171.7	203
Oa21	1020	40	1.81	3.86	163.7	152

Table 3-1: OLCI specification bands, in cyan MERIS heritage, in yellow additional bands.

Source, Credit: [The Global Monitoring for Environment and Security \(GMES\) SENTINEL-3 mission](#), C.Donlon et al.

3.2.2 Geophysical Measurements

Ocean colour sensors are designed to retrieve the spectral distribution of up-welling radiance just above the sea surface (the water-leaving radiance) that is used to estimate a number of geophysical parameters through the application of specific bio-optical algorithms. Atmospheric correction for ocean colour data is challenging, as only about 4% of the radiation measured by a satellite instrument originates from the water surface, and sensors require high Signal to Noise Ratios (SNR), particularly for the 'blue' bands (approximately 400 nm). Ocean colour instrument design must therefore incorporate extremely sensitive and stable radiometry, dedicated on-board calibration and a large number of spectral channels.

The [OLCI instrument](#) is a programmable, medium-spectral resolution, imaging spectrometer operating in the solar reflective spectral range (400 nm to 1 040 nm).

The instrument scans the Earth's surface using the push-broom method. CCD arrays provide spatial sampling in the across track direction, while the satellite's motion provides scanning in the along track direction. The OLCI swath is tilted 12.6° westwards to mitigate the negative impact of sun glint contamination. OLCI is designed to acquire data over the Earth whenever illumination conditions are suitable. The instrument's 68.5° field of view around nadir covers a swath width of 1 270 km. This wide field of view is shared between five identical optical modules arranged in a fan configuration. The Earth is imaged with a spatial resolution of 300 m (at nadir).

The scene is imaged simultaneously across the entire spectral range, through a dispersing system, onto the CCD array. Signals from the CCD pass through several processing steps to achieve the required image quality. These CCD processing steps include dumping of spectral information from unwanted bands and spectral integration to obtain the required bandwidth. On-board analogue electronics perform pre-amplification of the signal, correlated double sampling and gain adjustment before digitalisation. The on-board digital electronics system has two major functions: it completes the spectral integration and it performs offset and gain corrections in full processed mode.



Figure 3-2: RGB Image Over the Baltic Sea (MERIS FR sensor)

3.3 Applications

OLCI is the successor to MERIS aboard ENVISAT, the primary objective of which was to screen the [ocean](#) and [land surface](#) to harvest information related to biology (e.g. phenology of marine and terrestrial biomass). OLCI also provides reliable information on the [atmosphere](#), especially on the aerosols characterisation. All applications of OLCI including contributions to [climate study](#) are presented in this applications section.

For further information about applications and services available, see: [Copernicus website](#).

3.3.1 Maritime Monitoring

3.3.1.1 OLCI Marine

Measuring ocean colour from space allows information to be gathered about marine biological constituents. This measurement relates to water colouration (visible spectrum), which is affected by elements present in the water and especially by population with phytoplankton biomass (as indexed by Chl-a) which constitutes the first element of the trophic chain, and associated detrital material. For coastal and shallow waters, colouration of waters can also be the result of the release of terrestrial waters loaded with suspended sediment and organic matter, as well as re-suspension due to wave agitation. Initially designed for research studies in marine biology and carbon cycle, this observation technique has

spawned a number of applications oriented toward marine area management and coastal zone management. Known reliable applications making use of ocean colour that would benefit from OLCI, are summarised in the following sections.

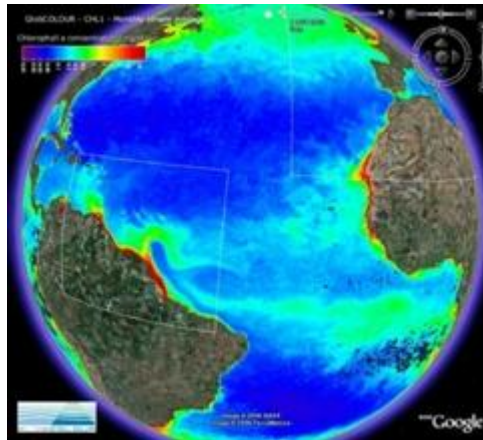

Figure 3-3: GlobColour Chlorophyll Monthly Product (image courtesy of ACRI-ST)

3.3.1.2 Net Primary Production Estimates

One of the important and unique applications of basin to global-scale Chl-a maps is to calculate global ocean primary production. Using algorithms that incorporate satellite-based Chl-a to calculate regional to global-scale estimates of annual Net Primary Production [¹](NPP) provides important insights into the function of ocean ecosystems and biogeochemical processes. A key finding from NPP calculation based on satellite data is that ocean and terrestrial NPP contributes more or less equally to global productivity [²]. As a result of the continuity over time of international ocean colour missions since 1998, NPP is monitored on a global scale. The essential function of carbon sink in the ocean is therefore regularly estimated. Climatic trends in such carbon uptake will be calculated once the time series of ocean colour observations is long enough, reinforcing the crucial need to maintain continuity in ocean colour missions over the next decades.

¹ Yoder, J.A., S.C. Doney, D.A. Siegel and C. Wilson. 2010. Study of marine ecosystems and biogeochemistry now and in the future: Examples of the unique contributions from space. *Oceanography* 23(4):104-117, doi:10.5670/oceanog.2010.09.

² Field, C.B., M.J. Behrenfeld, J.T. Randerson and P. Falkowski. 1998. Primary Production of the biosphere: Integrating terrestrial and oceanic components. *Science* 281:237-240

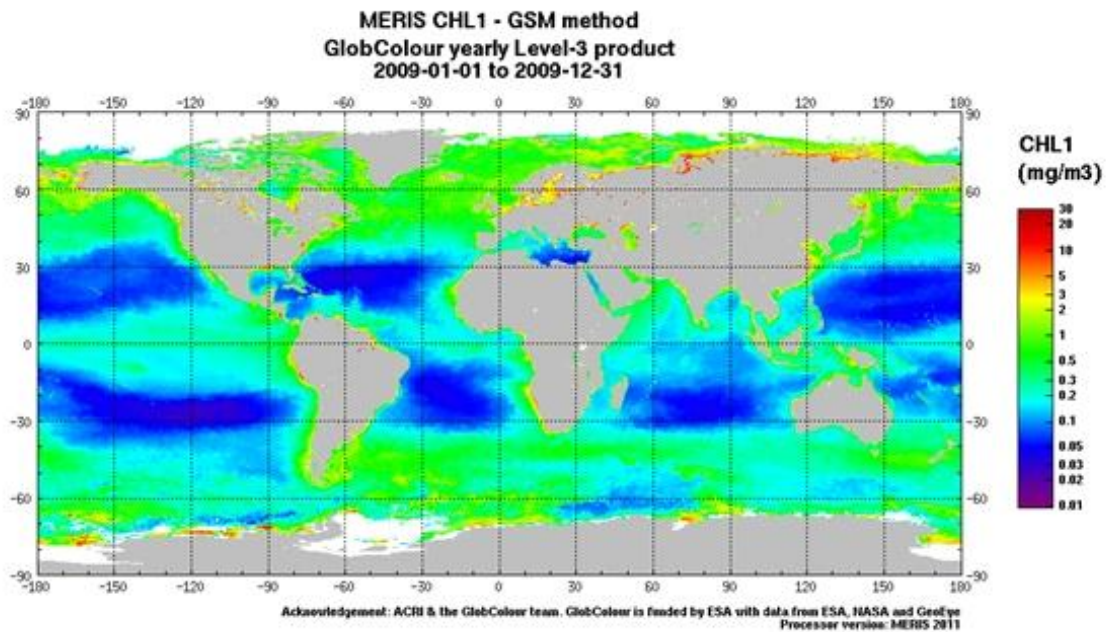

Figure 3-4: Composite image giving an indication of the magnitude and distribution of global primary production in the world's oceans (from a high of 30 mg/m³ in red to <0.01 mg in purple) (image courtesy of ACRI-ST)

3.3.1.3 Algal Bloom and Water Quality Monitoring

Algal bloom detection has been the subject of a number of intensive research works during the last decade. The results of these works have been transformed into an operational capacity to trigger alerts for some invasive micro-algae. Within the framework of the GMES Service Element (e.g. Coastwatch and Marcoast) operational services have been set up and are still operating. The next scientific challenge is, whenever possible, to identify the type of algae and the harmfulness of the detected species together with the bloom strength and extent.

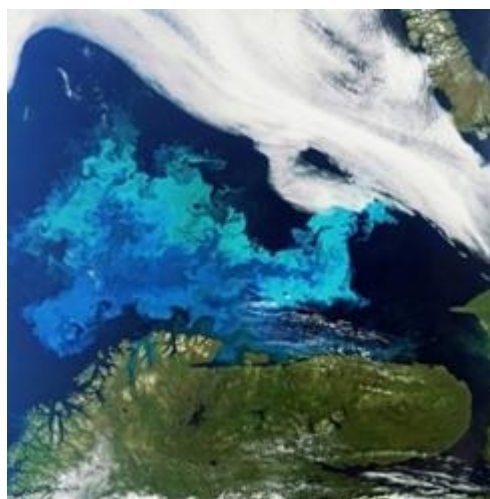

Figure 3-5: Algal Bloom North of Norway in the Barents Sea, MERIS image (image courtesy of ESA)

3.3.1.4 Mesoscales Process

As for SST, ocean colour provides spatial repartition of front and eddies at the ocean surface. The detection and identification of surface patterns can be achieved either using one of the available water-leaving reflectances at a given wavelength, or by a combination of them. Depending on the purpose, it can also be done with high level products such as water transparency, giving an integrated estimate of vertical visibility through the ocean upper layer. When oriented toward mesoscale circulations analysis or biological productivity (e.g. of large marine ecosystems, such as up-welling zones), these analyses are often performed by associating other Earth Observation measurements, such as SST and Sea Surface Height (SSH) (both available and collocated with ocean colour observations on SENTINEL-3). In this case, marine habitats have been analysed for some species as a function of these three components (Chl-a, SST, SSH) and indications can be provided in NRT (less than 3 hours after measurement by satellite) to optimise fish catches and/or to avoid fishing near protected species (e.g. turtles). Although still experimental, fish stocks and their evolution can then be assessed in productive zones (Large Marine Ecosystem).

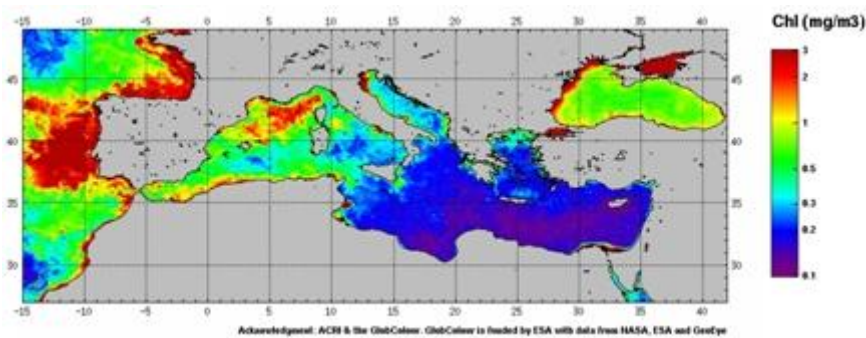

Figure 3-6: GlobColour Weekly Chlorophyll Product (March 2009 - from a high concentration of 3 mg/m³ in red to 0.1 mg in purple)(image courtesy of ACRI-ST)

3.3.1.5 Extension to 3D Marine Biology

Although limited to surface observation (the upper sea layer of one optical depth), several techniques, ranging from statistical to numerical, allow expansion of this information to greater depths and provide a better 3D description of the biological field. Besides this vertical extension, phytoplankton size class and types (e.g. diatoms) can also be determined from ocean colour through robust algorithms [3] [4].

The assimilation of Chl-a measurements from space, or of IOP in biogeochemical modelling, is under way.

3.3.1.6 Sedimentary Processes

Providing reliable atmospheric correction, ocean colour gives access to geographical extent and composition of turbid plumes, allowing monitoring of flood expansion and its impact at sea. This also provides a means of establishing the

³ Uitz, J., D. Stramski, B. Gentili, F. D'Ortenzio, and H. Claustre (2012), Estimates of phytoplankton class-specific and total primary production in the Mediterranean Sea from satellite ocean color observations, *Global Biogeochemical Cycles*, 26, GB2024, doi:10.1029/2011GB004055.

⁴ Alvain S., Moulin C., Dandonneau Y., and H. Loisel (2008) Seasonal distribution and succession of fominant phytoplankton groups in the global ocean : A satellite view., *Global Biogeochem. Cycles*, 22.

fluxes of terrestrial material at sea and of monitoring their fluctuations in space and time. This is particularly useful for the study of large estuaries.



Figure 3-7: Gironde Estuary, April 6th 2011, MERIS FR RGB Composite (image courtesy of ESA)

For further information about marine applications and services available, see: [Copernicus website](#).

3.3.2 Land Monitoring

Mapping and monitoring of Land Use and Cover (LUC) is defined as a priority research item in Europe (particularly in regards to Copernicus). Agricultural and environmental applications require reliable and actual information on LUC. The environment in Europe is constantly changing due to a combination of socio-economic and climatic processes. Extensive and various legal mechanisms have been defined at national and international level to protect the environment and ensure viable use of natural resources. These legal mechanisms are the basis for different activities in monitoring the environment and include the Amsterdam Treaty (1997), EU Habitats Directive, EU Common Agricultural Policy and the Kyoto Protocol.

For accurately monitoring large areas, and Europe in particular, remote sensing appears to be an appropriate tool. Previously in the Coordination of Information on the Environment (CORINE) land cover project, visual interpretation from LANDSAT-TM and SPOT-XS hard copies at a landscape level were used to produce an ecological legend [5]. The CORINE Land Cover (CLC) database was updated during the CLC 2006 project. Other approaches are used (automatic pixel-wise) as digital classification of the same type of pictures creating national land cover maps [6, 7, 8]. However, these approaches are costly and time-consuming, especially if applied at a European scale, as they use high spatial resolution images. Using coarse spatial resolution data, such as that provided by the NOAA-AVHRR sensor, is an alternative[9]. However, this imagery restricts use for monitoring purposes because the majority of European land cover changes occur

⁵ EC (1993) CORINE Land Cover: technical guide. Report EUR 12585 (European Commission, Luxembourg)

⁶ Thunnissen H A M, M N Jaarsma & O F Schouwman (1992) Land cover inventory in the Netherlands using remote sensing; application in a soil and groundwater vulnerability assessment system. *International Journal of Remote Sensing*, 13: 1693-1708

⁷ Thunnissen H A M & E Noordman (1997) National land cover database of The Netherlands: classification methodology and operational implementation. BCRS report 96-20 (BCRS, Delft) 95 pp.

⁸ Fuller R M, G M Smith, J M Sanderson, R A Hill & A G Thomson (2002) The UK land cover map 2000: construction of a parcel-based vector map from satellite images. *The Cartographic Journal*, 30(1): 15-25

⁹ Mûcher C A, K Steinnocher, F Kessler & C Huenks (2000) Land cover characterization and change detection for environmental monitoring of pan-Europe, *International Journal of Remote Sensing*, 21: 1159-1181

at fine scale. According to different case studies, a compromise between LANDSAT/SPOT and NOAA can be achieved using medium resolution images (i.e. from MERIS and MODIS)^[10]. The OLCI mission's land applications are designed to provide continuity with MERIS and MODIS.

ESA's GLOBCOVER initiative aims to develop and demonstrate a service for the generation of global land cover maps. This map is based on ENVISAT MERIS fine resolution (300 m) mode data. Presently, GLOBCOVER 2009 is considered as the most detailed and recent global land cover map available.



Figure 3-8: At 300 m resolution, GLOBCOVER Land Cover v2 provides a revealing portrait of global land use. To build this map, a colour representing one of 22 different land classifications is associated with each pixel. The associated land classification is define according to the predominant type of vegetation found at that location (image courtesy of ESA GLOBCOVER project).

The land surface albedo is the proportion of the incident light that is reflected by the land surface. This information is required for the the entire Earth's land surface (snow and snow-free) for initialisation and verification of Global Climate Model. To generate such a global map by temporal composition requires both sufficient directional looks and the very precise correction of top of atmosphere radiances to "at Surface" Directional Reflectances (SDRs). In addition, such a map requires precise radiometric calibration and inter-calibration of different sensors and computation of radiative transfer coefficients to derive broadband SDRs from different input narrowband SDRs and, given sufficient angular sampling from all the directional looks within a given temporal window, derive a suitable Bidirectional Reflection Distribution Function (BRDF). [GLOBALALBEDO project](#) has been set up by ESA to create a 15 year time series by employing SPOT-VEGETATION as well as MERIS. A gap-filling method has been put in place by using 10 year mean estimates derived from equivalent BRDFs from MODIS and to complement the dataset. It is likely that reflectances from OLCI would be used for such albedo derivation.

OLCI's spectral definition permits a fine characterisation of the vegetation with three parameters: the FAPAR, the LAI and the OTCI (see full description below). Concerning the Leaf Area Index (LAI) and similarly to flood water extent, this parameter is not a 'core product' but can be derived from rectified reflectances. The two other products are defined as Essential Climate Variables (ECV), designated by the Global Climate Observing System (GCOS) and specifically monitored as relevant indicators for climate evolution studies and trend analysis.

¹⁰ Jan Clevers, Harm Bartholomeus, Sander Múcher and Allard de Wit, (2004), Land Cover classification with the medium resolution imagin spectrometer), EARSeL eProceedings 3, 3/2004 354

3.3.2.1 FAPAR - Fraction of Absorbed Photosynthetically Active Radiation (ECV)

In order to monitor the state and evolution of terrestrial vegetation cover, OLCI acquires multi-spectral imagery of the Earth. Defined as an OLCI standard Level-2 product, the FAPAR is derived from the radiation measured over land surfaces. FAPAR has been defined to advantageously replace the Normalised Difference Vegetation Index (NDVI), provided it is itself properly estimated. Essential in the plant photosynthetic process, this bio-geophysical product is often used in diagnostic and predictive models computing primary productivity of the vegetation canopies. In addition, this parameter is also an input for the estimation of assimilation of CO₂ in vegetation. According to international organisations including GCOS, FAPAR is an essential surface parameter for the provision of Earth climate system data.



Figure 3-9: FAPAR derived from MERIS over Europe in July 2003. FAPAR is defined as the fraction of Photosynthetically Active Radiation (PAR) absorbed by a vegetation canopy. PAR is the solar radiation reaching the canopy in the 0.4–0.7 μm wavelength region. (image courtesy of JRC)

3.3.2.2 Leaf Area Index (LAI)(ECV)

For a given unit area, the LAI is defined as the ratio of upper leaf surface area to ground area, in the case of broadleaf canopies, and as projected conifer needle surface area to ground area in the case of coniferous plants. As LAI directly characterises canopy structure, it appears to be a good predictor of primary productivity and crop growth. In addition, because of its substantial influence on energy exchange, water vapour and CO₂ exchange between plants and the atmosphere, it is often used in ecosystem models. LAI is therefore required as an input for several ecosystem process models.

LAI can be an input for models of primary productivity or fire dynamics but can also be a parameter of interest on its own. Since direct LAI measurements would require taking all leaves from an area and quantifying their surface area per unit ground, the LAI estimates obtained by remote sensing are considered as approximations of true LAI. There are different mathematical models for calculating LAI, each of them containing specific assumptions and requiring specific inputs. Comprehension of the model assumptions and evaluation of its suitability in relation to available data are essential. In the same way, it is important to know how the model characterises the vegetation in function of field measurements and desired output. Since the majority of models are fine-tuned for a specific scale and for a specific ecosystem type, application of an existing model to another location may imply modifications of this model.

Even though LAI can be obtained from spectral vegetation indices, NDVI for instance, no single equation combining a set of coefficients and different surface types has been found. Using satellite imaging to estimate LAI requires a corrective process for atmospheric effects, topography and diurnal variations. In addition, values fluctuate quickly during a season

with varying phenology. On the other hand, using visible/near-infra-red images to estimate LAI requires a cloudless and clear image and when these conditions are fulfilled, LAI values are extracted from the best quality images over a multiple day period (usually 8 – 10 days). In case of continually cloudy areas, using LIDAR or radar is a good alternative to evaluate vegetation characteristics.

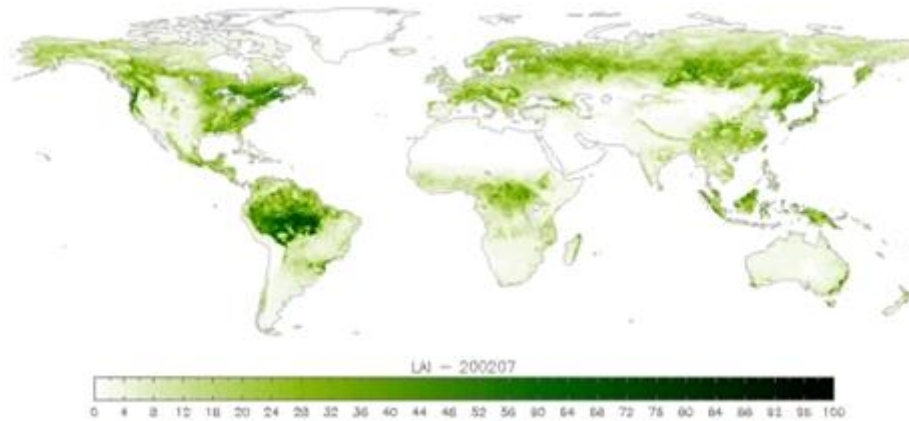

Figure 3-10: Worldwide Leaf Area Index (LAI) (image courtesy of ESA, data user element)

3.3.2.3 OLCI Terrestrial Chlorophyll Index (OTCI)

Considering the spectrum of vegetation canopy and the major chlorophyll absorption feature, the long wavelength edge moves to longer wavelengths when the chlorophyll content increases. Remote sensing estimation of the chlorophyll content of vegetation canopies has been successfully based on this relationship with Red-Edge Position (REP). However, in order to use the MERIS spectrum, the MERIS Terrestrial Chlorophyll Index (MTCI) has been developed. This index has several advantages: it is easily calculated (and suitable for automation), it is strongly correlated with REP and unlike REP, it is sensitive to high values of chlorophyll content. With the development of the OLCI instrument, and to pursue the development of MTCI, a similar index named OTCI has been created.

For further information about land applications and services available, see: [Copernicus website](#).

3.3.3 Atmospheric Monitoring

Three essential data can be extracted from OLCI observations related to atmosphere:

- the atmospheric composition (mainly aerosols and water vapour): essential information for climate studies and weather forecasting
- illumination condition (fraction of available natural light) of the observed area: a key input for biological studies
- downwelling solar radiation (long- and short-wave) at the Earth’s surface and top-of-atmosphere: critical information in estimating and monitoring the Earth Surface Radiation Budget (SRB).

3.3.3.1 Atmospheric Composition

Water vapour is both radiatively and chemically active, and so plays a key role in the atmosphere. It is the strongest greenhouse gas (GHGs), even if it is influenced more indirectly than directly by anthropogenic activity. It is an essential

indicator for convection and radiative forcing in the Upper Troposphere (UT) and Lower Troposphere (LT). In addition, in the stratosphere, water vapour is a source gas for hydroxide, a chemically active gas in the ozone budget. Scientific evidence confirms that the ascending branch of Brewer Dobson Circulation, controlling the balance of water vapour in the UT and in the LS, is modifying because of climate change. Using OLCI, scientists and weather forecasters have access to the integrated water vapour column measured over land and ocean.

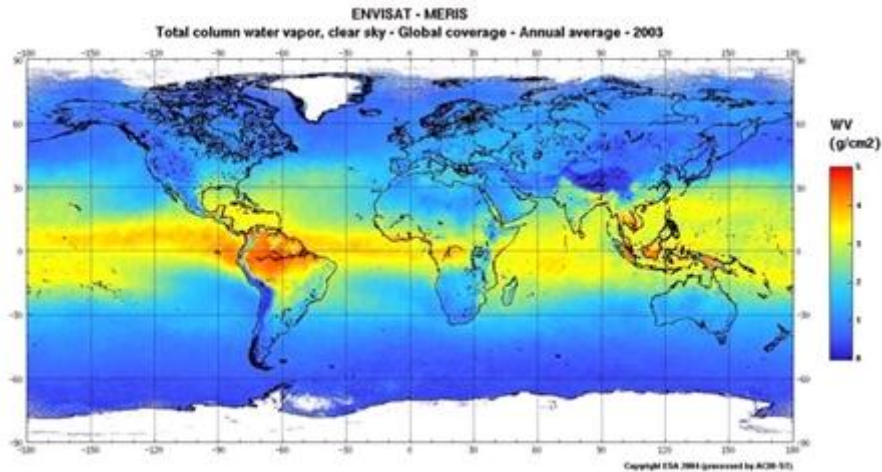

Figure 3-11: Total Column of Water Vapour (annual product 2003) (image courtesy of ACRI-ST)

By mass, atmospheric aerosols are minor components of the atmosphere, however, they are a crucial constituent of climate and particularly of climate change. Global radiation is impacted by aerosol which directly scatters solar radiation and indirectly influences cloud reflectivity, cloud cover and cloud life time.

Tropospheric aerosols can be formed in two different ways: either directly from the surface, e.g. sea salt from oceans or dust, smoke and soot from continents, or in the atmosphere through complex (photo-) chemical processes and reactions between gaseous components. These gaseous constituents came themselves from the surface, for example dimethyl sulphide (DMS) over oceans or sulphur and nitrogen oxides over continents. Most stratospheric aerosols originate in volcanic eruptions, powerful enough to inject Sulphur Dioxide (SO₂) into this layer. Apart from volcanic eruptions, stratospheric aerosols can arise from Oceanic Carbonyl Sulphide (OCS), from low SO₂ emissions (from Kilauea-type volcanoes) and other anthropogenic sources (industrial and aircraft operations). Climate is also affected by radiative effects induced by changes in cirrus cloud amounts, particle size and/or lifetime.

OLCI provides aerosol optical thickness and Angstrom exponents to scientists and weather forecasters.

3.3.3.2 Illumination Condition

Photosynthetically Active Radiation (PAR) is defined as the spectral range of solar radiation (in terms of wave band, from 400 to 700 nm) which photosynthetic organisms can use in the process of photosynthesis.

Agriculture, forestry and oceanography represent the main scientific fields using PAR measurements, to compute the euphotic depth in the ocean, for instance. OLCI products include PAR measurements for both land and ocean applications. Over land, this parameter ensures a link between plant status and available radiation. Over ocean, its value is necessary to compute primary production.

An essential component of surface energy budget is the Surface Radiation Budget (SRB). It is important to almost all aspects of climate and, therefore, required to be monitored systematically. SRB is composed of upward and downward

solar and thermal infra-red irradiances. To be used in climate applications, these components require complex strategies of measurement due to their high fluctuation over the electromagnetic spectrum, over time and position. In order to be a relevant part of climate research and assessment, it is essential to have well-analysed and planned measurement approaches of surface irradiance observations.

Radiation quantities are possibly responsible for forcing climate change, however these climate variations will alternately change observable radiation fields. As a consequence, it is required to proceed to a complex analysis of radiation observations for application to climate. Information on surface radiation budget is available from OLCI product.

For further information about atmospheric applications and services available, see: [Copernicus website](#).

3.3.4 Climate Change Monitoring

The work of the United Nations Framework Convention on Climate Change (UNFCCC) and of the Intergovernmental Panel on Climate Change (IPCC) are supported by the [Essential Climate Variables \(ECV\)](#). All ECV are designed to be technically and economically viable for systematic observation. International exchanges are required to fulfil databases with present and historical observations. There are 50 ECVs currently defined.

Supporting this international effort, a substantial number of OLCI products include some ECVs (as shown in the following table).

ECV	OLCI products
[Atmospheric Surface] Surface Radiation budget	Photosynthetically available radiation
[Atmospheric Upper Air] Water Vapour	Integrated water vapour column
[Atmospheric Composition] Aerosols properties	Aerosol optical thickness Aerosol Angstrom exponent
[Oceanic] Ocean Colour	Water leaving reflectances
[Oceanic] Phytoplankton	Algal pigment concentration
[Terrestrial] Albedo	Rectified reflectances
[Terrestrial] Land cover	Rectified reflectances
[Terrestrial] FAPAR	OLCI global vegetation index
[Terrestrial] Over ground biomass	OLCI terrestrial chlorophyll index

Table 3-2: Corresponding ECV and OLCI products

For further information about climate applications and services available, see: [Copernicus website](#).

3.4 Product Types

3.4.1 Introduction

The OLCI product types distributed to users are divided into three main products.

- [Level-1B product](#), output from the OLCI Level-1 processing. The Level-1 product provides reflectance for each pixel in the instrument grid, each view and each OLCI channel, plus annotation data associated to OLCI pixels.
- [Level-2 land products](#), output from the OLCI Level-2 processing. The level-2 land product provides land and atmospheric geophysical parameters computed for full and reduced resolution.
- [Level-2 water products](#), output from the OLCI Level-2 processing. The Level-2 water product provides water and atmospheric geophysical parameters computed for full and reduced resolution.

For further information about OLCI products, see the Technical Guide [Level-1 products](#) or [Level-2 products](#).

3.4.2 Level-1b

From the three processing modes of the OLCI Level-1 processor (Earth Observation (EO), radiometric calibration and spectral calibration) and the two available resolutions in EO (full and reduced resolution), four different [Level-1B products](#) can be obtained:

- OL_1_EFR, output during EO processing mode for full resolution
- OL_1_ERR, output during EO processing mode for reduced resolution.
- OL_1_RAC, output during radiometric calibration mode (internal products not disseminated to SENTINEL-3 users).
- OL_1_SPC, output during spectral calibration mode (internal products not disseminated to SENTINEL-3 users).

The Level-1B products in EO processing mode contain calibrated, ortho-geolocated and spatially re-sampled Top Of Atmosphere (TOA) radiances for the 21 OLCI spectral bands. The associated error estimates are also contained in the measurement data files. In full resolution products (i.e. at native instrument spatial resolution), these parameters are provided for each re-gridded pixel on the product image and for each removed pixel. In reduced resolution products (i.e. at a resolution four times coarser), the parameters are only provided on the product grid.

In addition to measurement datasets, annotation datasets provide:

- time stamps for each line of the product grid
- geolocation information for each pixel (and for each removed pixel in case of OL_1_EFR)
- quality flags, concerning surface or cloud identification, invalid or cosmetically filled pixels
- meteorological variables for each tie-point (defined on a specific grid: every 16 pixels for RR and every 64 pixels for FR products)
- geographical information and angles associated with each tie-point
- instrument features and settings needed in further processing such as detector index or OLCI channels, central wavelength and bandwidths.

3.4.3 Level-2 Land LRR and LFR

The OLCI [Level-2](#) land reduced or full resolution products, *OL_2_LFR* and *OL_2_LRR* respectively, are outputs from the OLCI Level-2 processor and contain land and atmospheric geophysical products at full and reduced resolutions. The content of these files depends on several switches included in the OLCI configuration parameters. Each geophysical parameter format is only triggered if the corresponding switch is set to '1'. Note that all pixels flagged as cloudy are discarded from OLCI Level-2 processing.

The only difference between *OL_2_LFR* and *OL_2_LRR* products is the spatial resolution, with a spatial sampling of approximately 300 m for full resolution and 1.2 km for reduced resolution. The products are assumed to be computed in near real-time (i.e. delivered to users less than 3 hours after acquisition), in non-time critical (i.e. within 1 month after acquisition) or in re-processed non-time critical.

Each product provides as measurement data files (more fully described in the table below):

- surface product as Global Vegetation Index (OGVI) and Terrestrial Chlorophyll Index (OTCI)
- atmosphere by-products as Integrated Water Vapour (IWV) column (this product also contains information for water pixels and is identical to that included in OL_2_WRR and OL_2_WFR)
- error estimates for all products.

Several associated variables are also provided in the annotations data files:

- rectified reflectance for red and MIR channels (RC681 and RC865)
- classification, quality and science flags (LQSF)
- common data such as the ortho-geolocation of land pixels, solar and satellite angles, atmospheric and meteorological data, time stamp or instrument information. These variables are inherited from Level-1B products.

Variables	Description	Units	Input Bands
OGVI	Fraction of Absorbed Photosynthetically Active Radiation (FAPAR) in the plant canopy	dimensionless	Oa3, Oa10, Oa17
OTCI	Estimates of the Chlorophyll content in terrestrial vegetation, aims at monitoring vegetation condition and health	dimensionless	-
IWV	Total amount of water vapour integrated over an atmosphere column	kg.m ⁻²	Oa18, Oa19
RC681 and RC865	By-products of the OGVI, the so-called red and NIR rectified reflectances, are virtual reflectance largely decontaminated from atmospheric and angular effects, and good proxy to Top of Canopy reflectances.	dimensionless	Oa10, Oa17

Table 3-3: Description of land and atmospheric geophysical product

The classification, quality and science flags provide information about validity, suspicious quality, cosmetic filling, environment and input quality.

3.4.4 Level-2 Water WRR and WFR

The OLCI [Level-2](#) water reduced or full resolution products, *OL_2_WFR* and *OL_2_WRR* respectively, are outputs from the OLCI Level-2 processor and contain water and atmospheric geophysical products at full and reduced resolution.

The content of these files depends on several switches included in the OLCI configuration parameters. Each geophysical parameter format is only triggered if the corresponding switch is set to '1'. Note that all pixels flagged as cloudy are discarded from OLCI Level-2 processing

The only difference between the *OL_2_WFR* and *OL_2_WRR* products is the spatial resolution.

Each product provides, as measurement data files (fully described in the table below):

- water-leaving reflectance (Rxxx) for all bands except those dedicated to measurement of atmospheric gas. Two types of reflectance are distinguished: the BAC reflectance for "Baseline Atmospheric Correction algorithm" (MERIS heritage) or AAC reflectance for "Alternative Atmospheric Correction algorithm" (based on a neural network procedure). BAC is used for the operational output of the reflectance in this product package but in cases where reflectances are computed and AAC is needed, a setting has been defined in the configuration file to switch between algorithms.
- ocean colour products such as algal pigment (chl_oc4me and chl_nn, in two separated files), Total Suspended Matter (TSM_NN) concentrations and transparency characterisation based on the Diffuse Attenuation coefficient (KD490_M07).
- neural network water-inherent optical properties such as CDM absorption (ADG_443_NN).
- atmosphere by-products such as Photosynthetically Active Radiation (PAR), Aerosol Optical Depth /Aerosol Angstrom exponent (gathered in one file and noted respectively as T865 and A865) and Integrated Water Vapour (IWV) column. Note that this last variable also contains information for water pixels and is identical to the one included in *OL_2_WRR* and *OL_2_WFR*.

- error estimates for all the products.

Several associated variables are also provided in the annotations data files:

- classification, quality and science flags (WQSF)
- common data such as the ortho-geolocation of land pixels, solar and satellite angles, atmospheric and meteorological data, time stamp or instrument information. These variables are inherited from Level-1B products

Variables	Description	Units	Input Bands
Rxxx	Surface directional reflectance, corrected for atmosphere and sun specular reflection.	dimensionless	all except Oa13, Oa14, Oa15, Oa19 and Oa20
chl_oc4me and chl_NN	Chlorophyll-a concentration, computed using "OC4Me" or Neural Network algorithms.	mg (chl a) m ⁻³	- Oa3 and Oa6 - Oa1-Oa12, Oa16, Oa17 and Oa21
TSM_NN	Total suspended matter concentration.	g.m ⁻³	Oa1-Oa12, Oa16, Oa17 and Oa21
KD490_M07	Diffuse attenuation coefficient for down-welling irradiance, at 490 nm.	m ⁻¹	Oa4 and Oa6
ADG_443_NN	Absorption of coloured detrital and dissolved material at 443 nm.	m ⁻¹	Oa1, Oa12, Oa16, Oa17, Oa21
PAR	Quantum energy flux from the sun in the spectral range 400-700 nm.	μEinstein.m ⁻² .s ⁻¹	-
T865 and A865	Aerosol load, expressed in optical depth at a given wavelength (865 nm) and spectral dependency of the aerosol optical depth, between 779 and 865 nm.	dimensionless	Oa5, Oa16 and Oa17
IWV	Integrated Water Vapour column	kg.m ⁻²	Oa18, Oa19

Table 3-4: Description of water and atmospheric geophysical product

The WQSF file provides information about validity, suspicious quality, cosmetic filling, environment and algorithm status.

3.5 Processing Levels

The OLCI operational processor is divided into three major processing levels.

- [Level-0 processing](#) aims to extract and check the raw data contained in the ISPs. These data are time sorted and annotated.
- [Level-1 processing](#) is divided into three processing modes. Earth Observation mode deals with Level-0 products to compute radiometric measurements for each OLCI band. Radiometric and spectral calibration processing modes aim to compute calibration coefficients.
- [Level-2 processing](#) is divided into two main sections, one associated with Level-1 products to compute water products, the other associated with land products.

3.5.1 Level-0

Level-0 processing aims to generate [Level-0 products](#), i.e. time sorted and annotated data from Instrument Source Packet (ISP). The Level-0 products are internal products not disseminated to SENTINEL-3 users.

The first part of the process involves unpacking the ISPs, performing a quality check and appending annotation data to them. Once the input raw data files are read, all necessary data are extracted and parsed. The ISPs are sorted and checked, including missing and duplicated packet numbering.

The final part of the processing is the Level-0 product generation. Several quality flags are computed and included in the associated metadata. Raw data, time sorted and annotated are included in the Level-0 package.

3.5.2 Level-1

OLCI [Level-1](#) processing is divided into three independent sections, each computed only if the dedicated switch (configured by the users) is set to '1'.

Earth Observation (EO) processing inputs are Level-0 products, the orbits scenario file and several auxiliary data files providing calibration coefficient, surface classification or threshold for bright and glint classification. Its output is [Level-1B](#) data, i.e. radiometrically calibrated, geo-referenced and annotated radiances.

EO processing mainly consists of calibrating the numerical counts contained in ISPs into radiances, geo-locating acquired pixels on the Earth's surface and re-sampling the image onto an orthogonal product grid, representing the instrument's ideal swath. The final steps involve quality flags, meteorological annotations and pixel classification flags, appended with computed variables to the outputted Level-1B products.

EO processing is divided into seven steps:

1. Data extraction and quality checks from ISP products.
2. Radiometric scaling: aiming to derive calibrated TOA radiance values from the numerical counts previously extracted. This section is itself divided into six sub-sections: initialisation, non-linearity correction, dark signal correction, smear correction, absolute gain calibration and cosmetic pixel filling.
3. Stray light correction: a two-step process aiming to estimate and correct stray light contamination.
4. Geo-referencing: aiming to compute, for every pixel, the first intersection between the pixel line-of-sight and the Earth's surface (assumed to be perfectly represented by the WGS84 Reference Ellipsoid completed by a Digital Elevation Model).
5. Pixel classification: aiming to characterise the pixels according to classes of underlying surface, whatever the atmospheric conditions, to provide preliminary detection of cloudy pixels and to detect pixels showing a risk of contamination by sun glint.
6. Spatial re-sampling: aiming to define and fill the output products grids, taking into account the full resolution and the reduced resolution grids.
7. Product formatting: aiming to produce the OL_1_EFR and OL_1_ERR products.

Note that data extraction, quality checks, instrument count corrections (included in the radiometric scaling step) and product formatting sub-sections are common, or share commonalities with the three processing levels.

OLCI Radiometric Calibration (RC) processing is based on the same inputs as EO processing and outputs a set of calibration Look-Up-Tables (LUTs). The associated steps are:

1. Acquisition geometry.
2. Diffuser radiance computation, determining the radiance at instrument entrance, from knowledge of the acquisition geometry, sun flux and the diffuser bi-directional reflectance.
3. Stray light computation, similar to stray light correction in EO processing.
4. Radiometric LUT computation.

OLCI spectral calibration processing aims to accurately determine the central wavelengths of specific rows of the detector arrays and contributes to the overall accuracy and reliability of the instrument spectral model used during radiometric

calibration and Earth Observation data processing. Its input is two Level-0 products, pertaining to two successive orbits. The associated steps are:

OLCI spectral calibration processing aims to accurately determine the central wavelengths of specific rows of the detector arrays and contributes to the overall accuracy and reliability of the instrument spectral model used during radiometric calibration and Earth Observation data processing. Its input is two Level-0 products, pertaining to two successive orbits. The associated steps are:

1. Relative spectral calibration containing a data extraction and quality check sub-process (once for each input Level-0 product) and an instrument count correction sub-process (once for each input Level-0 product). A final sub-process derives the spectral diffuser's relative spectral BRDF from corrected counts of both diffusers.
2. Wavelength calibration analysing the above and deriving absolute wavelength characterisation of the instrument, over the whole field of view, by comparison of measured spectral BRDF to a reference.

3.5.3 Level-2

OLCI [Level-2](#) processing is divided into two main processes:

- Ocean processing, providing *OL_2_WFR* and *OL_2_WRR* products
- Land processing, providing *OL_2_LFR* and *OL_2_LRR* products.

In addition a common pre-processing and product formatting process aims to read and check the input, and to define and write the outputs.

It is important to note that, for each geophysical parameter included in the OLCI Level-2 product, a switch has been defined in the OLCI Level-2 configuration file. Each parameter and its associated flags are produced only if the associated switch is set to '1'. As a consequence, the module generating each parameter is triggered only if the appropriate switch is set to '1'.

The pre-processing module, starting from the Level-1B TOA radiances, derives reflectances corrected for gaseous absorption and the smile effect. The consolidation of pixel classifications from Level-1B and the definition of water vapour retrieval are included in this module.

The algorithm is divided into six successive steps:

1. The conversion from radiances to reflectances step-checks the Level-1B products and converts radiances into reflectances (also known as first instrumental correction).
2. To be correctly taken into account or to be rejected from the algorithm, pixels have to be differentiated according to four criteria: cloud, land, water and invalid pixels. The first pixel classification focuses on identification of cloudy pixels. This Cloud masking will be improved in the frame of coming evolutions, including the improvement tested and validated during the MERIS 4th reprocessing.
3. Gaseous correction: correcting reflectances for gaseous absorption (i.e. O₂, H₂O and O₃). Five OLCI bands are dedicated to this correction and are not used after this step: Oa13 to Oa15, Oa19 and Oa20.
4. The second pixel classification estimates glint reflectance and completes pixel classification starting at the second step by consolidating the classification land and water pixels.
5. Smile correction is applied to TOA reflectance in the case of small scale variations due to the non-constant central wavelength of a given band across the field of view. It is also known as the second instrumental correction.
6. The water vapour process retrieves atmospheric water vapour content from clear sky pixels.

The ocean processing module provides water-leaving reflectances, computing and subtracting from the total signal, the atmosphere contribution and deriving the necessary geophysical products.

The first step is performed using two algorithms, selectable by a dedicated switch (included in the OLCI Level-2 configuration file):

- Baseline Atmospheric Correction removes all the contributions to TOA reflectances, beginning with glint correction and white cap effects, followed by estimation of the near-infra-red water-leaving reflectance to perform atmospheric correction.
- Alternate Atmospheric Correction uses a neural network approach to provide water-leaving reflectances.
- Several steps (*OC4Me Chlorophyll*, *IMT Neural Net*, *Transparency Product*, *PAR Product*) compute all the needed products from the water-leaving reflectances.

The land processing module consists of two independent sections (one for each product):

- The OLCI Global Vegetation Index (OGVI) section combines the information contained in the blue band with that contained in the bands at 681 and 865 nm to generate "rectified channels" at these latter two wavelengths.
- The OLCI Terrestrial Chlorophyll Index (OTCI) section uses Rayleigh correction to produce the necessary index.

3.6 Resolutions

The OLCI instrument measures reflected solar radiation from the Earth's surface and clouds simultaneously in [21 spectral bands](#).

OLCI products are available at two spatial resolutions:

- [Full Resolution](#) (FR) at approximately 300 m
- [Reduced Resolution](#) (RR) at approximately 1.2 km.

Data are processed in FR mode if any charted land is within a 300 km range of the nominal swath, otherwise the processing is in RR mode.

3.6.1 Spatial Resolution

3.6.1.1 Full Resolution (FR)

To simplify OLCI operations, maximise instrument autonomy and offer maximum flexibility for data processing and re-analysis, OLCI always operates (both land and ocean) in full resolution mode.

For the nominal orbit, at sub-satellite point, full spatial resolution of the OLCI instrument is approximately 300 m.

3.6.1.2 Reduced Resolution (RR)

From Level-1B, OLCI products are provided in a sub-sampled version, at a resolution four times coarser and referred to as RR.

RR is obtained by averaging the signal of 16 full spatial resolution pixels. More precisely, four adjacent pixels across track for four successive pixel lines along track are used.

For the nominal orbit, at sub-satellite point, reduced spatial resolution of the OLCI instrument is approximately 1.2 km.

3.6.2 Radiometric Resolution - 21 bands in VIS/SWIR

OLCI observation is performed simultaneously in 21 spectral bands, listed in the table below, ranging from the visible to the near-infra-red (400 nm to 1 020 nm). Each of these bands is programmable in position and width.

Band	λ centre (nm)	Width (nm)	Function
Oa1	400	15	Aerosol correction, improved water constituent retrieval
Oa2	412.5	10	Yellow substance and detrital pigments (turbidity)
Oa3	442.5	10	Chl absorption max., biogeochemistry, vegetation
Oa4	490	10	High Chl, other pigments
Oa5	510	10	Chl, sediment, turbidity, red tide
Oa6	560	10	Chlorophyll reference (Chl minimum)
Oa7	620	10	Sediment loading
Oa8	665	10	Chl (2nd Chl abs. max.), sediment, yellow substance/vegetation
Oa9	673.75	7.5	For improved fluorescence retrieval and to better account for smile together with the bands 665 and 680 nm
Oa10	681.25	7.5	Chl fluorescence peak, red edge
Oa11	708.75	10	Chl fluorescence baseline, red edge transition
Oa12	753.75	7.5	O2 absorption/clouds, vegetation
Oa13	761.25	2.5	O2 absorption band/aerosol corr.
Oa14	764.375	3.75	Atmospheric correction
Oa15	767.5	2.5	O2A used for cloud top pressure, fluorescence over land
Oa16	778.75	15	Atmos. corr./aerosol corr.
Oa17	865	20	Atmos. corr./aerosol corr., clouds, pixel co-registration
Oa18	885	10	Water vapour absorption reference band. Common reference band with SLSTR instrument. Vegetation monitoring
Oa19	900	10	Water vapour absorption/vegetation monitoring (max. reflectance)
Oa20	940	20	Water vapour absorption, atmos./aerosol corr.
Oa21	1 020	40	Atmos./aerosol corr.

Table 3-5: Band characteristics of the SENTINEL-3 Ocean and Land Colour Instrument (OLCI).

3.7 Coverage

OLCI scans the Earth's surface using a push-broom method. CCD arrays provide spatial sampling in the across track direction, while the satellite's motion provides scanning in the along track direction. The instrument's 68.5° field of view, nadir pointing, covers a swath width of 1 270 km at altitude from SENTINEL-3 orbit (814.5 km). For the nominal orbit, at sub-satellite point, full spatial resolution (FR) of the OLCI instrument is approximately 300 m.

The SENTINEL-3 OLCI instrument has a 100% overlap with the [SLSTR](#) instrument swath.

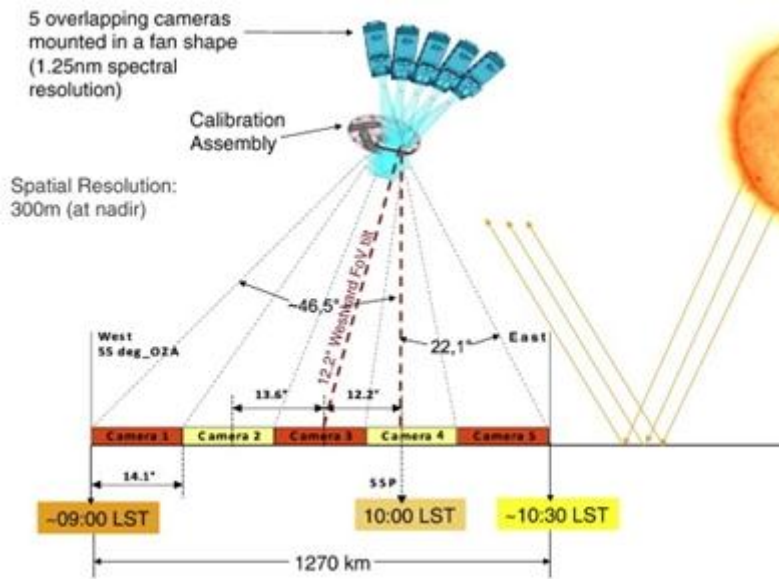

Figure 3-12: Basic geometry of the OLCI, showing the fan arrangement of the five cameras that will view Earth through the calibration assembly and the off-nadir pointing of the instrument swath. The Observation Zenith Angle (OZA) is limited to a maximum of 55°. The swath is 1 270 km. The Local Solar Time (LST) of observations is indicated in the lower part of the figure.

OLCI's field of view allows global coverage to be provided in 2-3 days, as required by oceanographic, land and atmospheric investigations.

	Constellation configuration	Revisit at equator	Revisit for latitude > 30°	Specification
Ocean colour (sun-glint free, day only)	1 satellite	< 3.8 days	< 2.8 days	< 2 days
	2 satellites	< 1.9 days	< 1.4 days	
Land colour (day only)	1 satellite	< 2.2 days	< 1.8 days	< 2 days
	2 satellites	< 1.1 days	< 0.9 days	

Table 3-6: Global coverage revisit times for OLCI optical measurements

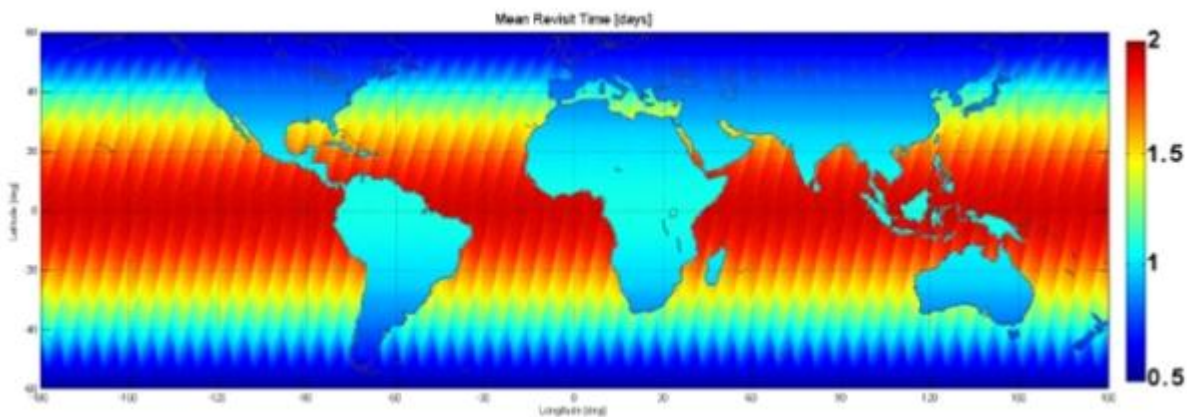

Figure 3-13: OLCI mean revisit time with a two-satellite configuration, in red 2 days are required to have revisit at equator, in blue less than 0.5 days at high latitude.

3.8 Naming Convention

The file naming convention for OLCI products ([see this document for more details](#)) is identified by the sequence of fields described here:

MMM_OL_L_TTTTTT_yyyymmddThhmmss_YYYYMMDDTHHMMSS_YYYYMMDDTHHMMSS_[instance ID]_GGG_[class ID].SEN3

- **MMM** is the mission ID:
 - S3A = SENTINEL-3A
 - S3B = SENTINEL-3B
 - S3_ = for both SENTINEL-3A and 3B
- **OL** is the data source/consumer (OL = OLCI)
- **L** is the processing level
 - "0" for Level-0
 - "1" for Level-1
 - "2" for Level-2
 - underscore "_" if processing level is not applicable.
- **TTTTTT** is the Data Type ID
 - Level-0 OLCI data:
 - "EFR____" = full resolution ISPs
 - "CR1____" = calibration with spectral relaxation
 - "CR0____" = calibration with no spectral relaxation.
 - Level-1 OLCI data:
 - "EFR____" = TOA radiances at full resolution
 - "ERR____" = TOA radiances at reduced resolution
 - "RAC____" = dark offset and gain coefficients from radiometric calibration
 - "SPC____" = wavelength characterisation from spectral calibration
 - "INS_AX" = instrument characterisation auxiliary data
 - "EFR_BW" = browse product derived from "EFR____"
 - "ERR_BW" = browse product derived from "ERR____".
 - Level-2 OLCI data:
 - "WFR____" = full resolution ocean colour, water and atmosphere parameters
 - "WRR____" = reduced resolution ocean colour, water and atmosphere parameters

- "LFR____" = full resolution land colour and atmosphere parameters
- "LRR____" = reduced resolution land colour and atmosphere parameters
- "ATP_AX" = atmosphere parameters auxiliary data
- "AER_AX" = aerosol climatology auxiliary data
- "LAP_AX" = land aerosol parameter auxiliary data
- "LVI_AX" = land vegetation index auxiliary data
- "WFR_BW" = browse product derived from "WFR____"
- "WRR_BW" = browse product derived from "WRR____"
- "LFR_BW" = browse product derived from "LFR____"
- "LRR_BW" = browse product derived from "LRR____".
- **yyyymmddThhmmss** is the sensing start time
- **YYYYMMDDTHHMMSS** is the sensing stop time
- **YYYYMMDDTHHMMSS** is the product creation date
- **[instance ID]** The field consists of 17 characters, either uppercase letters or digits or underscores "_".
The instance id fields include the following cases, applicable as indicated:
 1. Instance ID for the instrument data products disseminated in "stripes":
Duration, "_", cycle number, "_", relative orbit number, "_", 4 underscores "_"
DDDD_CCC_LLL_____
 2. Instance ID for the instrument data products disseminated in "frames":
Duration, "_", cycle number, "_", relative orbit number, "_", frame along track coordinate
DDDD_CCC_LLL_FFFF
 3. Instance ID for the instrument data products disseminated in "tiles".
Two sub-cases are applicable:
 - a) tile covering the whole globe:
"GLOBAL_____"
 - b) tile cut according to specific geographical criteria:
Tile Identifier
tttttttttttttttt
 4. Instance ID for auxiliary data:
17 underscores "_"
- **GGG** identifies the centre which generated the file

- **[class ID]** identifies the class ID for instrument data products with conventional sequence "P_XX_NNN" where:
 - P indicates the platform (O for operational, F for reference, D for development, R for reprocessing)
 - XX indicates the timeliness of the processing workflow (NR for NRT, ST for STC, NT for NTC)
 - NNN indicates the baseline collection or data usage.
- **.SEN3** is the filename extension.

Example of filename:

S3A_OL_1_EFR_____20151102T094537_20151102T094837_20151103T075458_0180_090_022_____LN2_D_NT_001.SEN3

3.9 Data Formats & Sizes

The OLCI data format follows the format defined for each SENTINEL-3 product in the PDGS product specification and is based on SENTINEL-SAFE. Each product package includes:

- a manifest file containing a metadata section and a data object section
- measurement data files
- annotation data files, if defined
- for Level-0 only, representation data files (XML files describing the binary information).

User products, generated for operational dissemination to the SENTINEL-3 users, must be distinguished from internal products, used only internally for normal processing.

Level	Name of Product Package	Main Content	Availability	Latency	Estimated Size per half orbit	Product Dissemination Unit
0	OL_0_EFR	Full Resolution ISPs	INTERNAL	NRT	9.5Gb	N/A
0	OL_0_CR0	Calibration with no spectral relaxation	INTERNAL	NRT	502Mb	N/A
0	OL_0_CR1	Calibration with spectral relaxation	INTERNAL	NRT	240Mb	N/A
1	OL_1_EFR	Full resolution top of atmosphere reflectance	USER	NRT/NTC	28.5Gb	Frame
1	OL_1_ERR	Reduced resolution top of atmosphere reflectance	USER	NRT/NTC	2.3Gb	Stripe
1	OL_1_RAC	Dark offset and gain coefficients from radiometric calibration	INTERNAL	NRT	1Mb	N/A
1	OL_1_SPC	Wavelength characterization from spectral calibration	INTERNAL	NRT	27Mb	N/A
2	OL_2_WFR	Full resolution water and atmosphere geophysical products	USER	NRT/NTC	28.4GB	Frame
2	OL_2_LFR	Full resolution land and atmosphere geophysical products	USER	NRT/NTC	8.8GB	Frame
2	OL_2_WRR	Reduced resolution water and atmosphere geophysical products	USER	NRT/NTC	2.4GB	Stripe
2	OL_2_LRR	Reduced resolution land and atmosphere geophysical products	USER	NRT/NTC	1.1GB	Stripe

Table 3-7: Description and content of the OLCI product package, the estimated size corresponds to a half orbit without consideration about compression, NRT/NTC less than 3/48 hours after measurement by satellite.

EFR = Earth Observation Full Resolution
 ERR = Earth Observation Reduced Resolution
 RAC = Radiometric Calibration
 SPC = Spectral Calibration
 WFR = Water Full resolution
 LFR = Land Full resolution
 WRR = Water Reduced Resolution
 LRR = Land Reduced Resolution

3.9.1 Level-0

The OLCI Level-0 product is composed of three different packages, all designed for internal use.

- The *OL_o_EFR* package contains the full resolution ISPs raw data (time-sorted and annotated).
- The *OL_o_CRO* package contains parameters from the calibration processing, computed with no spectral relaxation, i.e. with data acquired at 46 micro-bands.
- The *OL_o_CR1* package contains parameters from the calibration processing, computed with spectral relaxation, i.e. with data acquired at 22 bands.

Each package includes a manifest file and several data files. The content and the format of each Level-0 product are similar for these three packages. The only difference is the size, since the calibration processing is limited to 1 500 frames.

The manifest file is written in XML and contains information such as identifiers, or textual descriptions, concerning the product and the processing.

The measurement data file is a binary file containing the time-ordered raw data contained previously in the ISP. The content is the same as the ISP downlinked from the spacecraft platform to the receiving ground station. A selection is performed to discard duplicated and corrupted packets from the Level-0 product.

Two annotations data files are included in the Level-0 product: the ISP annotation data file and the OnLine Quality Control (OLQC) report. The ISP annotations data file includes time stamps, and ISP and FEP annotations.

Two representation data files are included in the *OL_o_EFR* product. These files describe in XML schema, the format of the measurement data file and of the ISP annotation data file.

3.9.2 Level-1

The OLCI Level-1 data is divided into four product packages (two of which are internal products). Each is composed of an information package map, also called a manifest, and several measurement and annotation data files.

- *OL_1_EFR*, providing the OLCI Level-1 full resolution product, includes 22 measurement data files and seven annotation data files.
- *OL_1_ERR*, providing the OLCI Level-1 reduced resolution product, includes 21 measurement data files and seven annotation data files.
- *OL_1_RAC*, providing internal dark offset and gain coefficient from radiometric calibration: includes one measurement data file and one annotation data file.
- *OL_1_SPC*, providing internal wavelength characterisation from spectral calibration: includes one measurement data file and two annotation data files.

For full resolution and reduced resolution products, the measurement files are written in netCDF 4 format and contain the TOA radiances and their error estimates for each OLCI channel (21 channels).

OL_1_EFR is also composed of one file providing data for each removed pixel, the 21 associated radiances, geographical position, associated angles and flags.

The annotation data files, also written in netCDF 4 format, are similar and described in the following table.

File Name	Dimensions	Contents
timeCoordinates	Number of lines in the product image	Time stamp
geoCoordinates	Number of lines and columns in the product image.	Longitude, latitude, altitude.
qualityFlags	Number of lines and columns in the product image.	Quality flags.
tie_geoCoordinates	Number of lines and columns in the tie-point grid.	Longitude, latitude.
tie_geometries	Number of lines and columns in the tie-point grid	Sun and observation angles.
tie_meteo	Number of lines and columns in the tie-point grid.	ECMWF data.
instrumentData	Number of lines and columns in the product image, number of instrument detectors per frame and number of OLCI bands.	Detector Index, OLCI channels central wavelength and bandwidth, solar irradiance.

Table 3-8: Description of annotation data files included in OLCI user products

For calibration products, the content is similar, written in netCDF 4 and described in the following table.

File Name	Product	File Type	Dimensions	Contents
radiometricCoef	OL_1_RAC	Meas.	Number of instrument detectors, number of OLCI band and number of dark and blank pixels.	Dark offsets and currents coefficients; gain coefficients and time average of the dark/blank pixels acquired in shutter or diffuser position.
RC_annotations	OL_1_RAC	Annot.	Number of instrument detectors, number of OLCI band and number of OLCI cameras.	Quality flags, valid acquired pixels used in different computation and statistics of CCD temperature in shutter or diffuser position.
calWavelengths	OL_1_SPC	Meas.	Number of used frames, of selected row, number of instrument detectors, of OLCI camera and number of dark/blank pixels.	Central wavelengths, time average of the dark/blank pixels acquired in shutter or diffuser position.
TimeCoordinates	OL_1_SPC	Annot.	Number of used frames.	Time stamps.
SC_annotations	OL_1_SPC	Annot.	Number of used frames, of selected row, of instrument detectors and of OLCI camera.	Quality flags and statistics of CCD temperature in shutter or diffuser position.

Table 3-9: Description of OLCI Level-1 product from calibration processing

Associated with each file, an information package map describes the content unit identifier and description, and the type of data contained in each file. An XML manifest file contains metadata associated with the instrument and the processing.

3.9.3 Level-2

The OLCI Level-2 product is composed of four packets, all available to the user depending on processing parameters.

- *OL_2_WFR* includes full resolution water and atmosphere geophysical parameters.

- *OL_2_LFR* includes full resolution land and atmosphere geophysical parameters.
- *OL_2_WRR* and *OL_2_FRR* include the same parameters but are computed at reduced resolution.

Each is composed of an information package map, also called a manifest, and several measurement and annotation data files.

The manifest file is written in XML and contains general information concerning the product and processing. The measurement and annotation data files are written in netCDF 4 format and include dimensions, variables and associated attributes.

The *OL_2_WFR* and *OL_2_WRR* packages include 24 measurement data files and seven annotations data files. The measurement files include 16 files containing water-leaving reflectances and their error estimates for all bands, except those dedicated to measurement of atmospheric gas (Oa13 to Oa15, Oa19 to Oa20). These files are produced on the product grid.

The other measurement files provide several marine and inland water products and associated error estimates:

- OC4Me Chlorophyll concentration
- neural net Chlorophyll concentration
- neural net total suspended matter concentration
- transparency products (Diffuse Attenuation coefficient)
- neural net water-inherent optical properties
- photosynthetically active radiation
- aerosol over water
- integrated water vapour over water.

The annotation files are similar to those included in *OL_1_EFR* and *OL_1_ERR* except the quality flags file is renamed "WQSF".

The *OL_2_LFR* and *OL_2_LRR* packages include three measurement data files and eight annotation data files. The measurement files provide the OLCI Global Vegetation Index (OGVI), the OLCI Terrestrial Chlorophyll Index (OTCI) and the Integrated Water Vapour (IWV) column. Each parameter is associated with error estimates and computed on the product grid.

The annotations files are similar to the ones included in *OL_1_EFR* and *OL_1_ERR*, but:

- the quality flag file is renamed "LQSF"
- one new annotation flag provides the rectified reflectance for the band Oa10 (named RC681) and for the band Oa17 (named RC865) and their error estimates

3.10 Definitions

3.10.1 Units

The table below summarises the geophysical units used in the OLCI Level-2 products.

	Product Name	Acronym	Units
MARINE AND INLAND WATERS	water-leaving reflectance	Rxxx	dimensionless
	Total backscattering coefficient	BBP560_M07	m ⁻¹

		BBP443_NN	
	Total absorption coefficient	ATOT443_NN	m ⁻¹
	Phytoplankton absorption coefficient	APH443_NN	m ⁻¹
	CDM absorption coefficient	ADG443_NN	m ⁻¹
	Algal pigment concentration	CHL_OC4ME CHL_NN	mg(Chl a).m ⁻³
	Total suspended matter concentration	TSM_NN	g.m ⁻³
	Diffuse attenuation coefficient	KD490_M07 KD490_L05	m ⁻¹
	Heated layer depth	ZHL	m
	Water transparency	ZSD	m
	Photosynthetically active radiation	PAR	μEinstein.m ⁻² .s ⁻¹
	Aerosol optical thickness	T865	Dimensionless
	Aerosol Ångström exponent	A865	Dimensionless
	Integrated water vapour column	IWV	kg.m ⁻²
	Ocean products quality and science flags	WQSF	Dimensionless
LAND	OLCI Global Vegetal Index (faPAR)	OGVI	Dimensionless
	Rectified Reflectance	RC681, RC865	Dimensionless
	OLCI Terrestrial Chlorophyll Index	OTCI	Dimensionless
	Integrated water vapour column	IWV	kg.m ⁻²
	Land products quality and science flags	LQSF	Dimensionless

Table 3-10: Units of OLCI Level-2 products

Other general quantities have the units shown in the table below.

Quantity	Unit	Notation	Description
Irradiance	10 ⁻³ W.m ⁻² .μm ⁻¹	IU	spectral irradiance unit
Radiance	10 ⁻³ W.m ⁻² .sr ⁻¹ .μm ⁻¹	LU	spectral radiance unit
Time	jd or MJD	jd or MJD	modified Julian date 2000
	10 ⁻⁶ s	(1.e-6)s	microsecond
Distance	10 ⁻⁹ m	nm	nanometre (wavelength)
	10 ⁻⁶ m	μm	micrometre (wavelength)
	m	m	metre
	10 ³ m	km	kilometre
Percentage	%	%	percentage
Temperature	K	K	degree Kelvin
	C	C	degree Celsius
Angle	°	deg	degree
	rad	rad	radian
Solid Angle	sr	sr	steradian
Pressure	hPa	hPa	hectoPascal
Ozone	kg.m ⁻²	kg.m ⁻²	kilogram per square metre
Dimensionless quantities	nc	nc	numerical counts
	dl	dl	dimensionless
Multiple dimension quantities	md	md	table constituted with different physical parameters having different units

Table 3-11: General quantities and their units

3.10.2 Product Grid

The OLCI product grid has been defined by upstream Level-1B products. Parameters included in the Level-1B products are ortho-geolocated and re-gridded during a specific step including in Level-1 processing (the re-sampling stage).

The grid applied at this stage is evenly spaced at the reference ellipsoid surface in the across track direction and is quasi-evenly spaced in the along track direction, since data are evenly sampled in time along the orbit of the satellite.

The across track sampling distance is equal to the SSD at the Sub-Satellite Point (SSP), i.e. about 300 m in full resolution mode and 1.2 km in reduced resolution mode. The grid used in RR mode is a 4 by 4 sub-grid of the FR product grid.

The nominal observation time window along an orbit is driven by the sun zenith angle at SSP being below 80°. It results in a duration of approximately 44 minutes, yielding approximately 60 000 (15 000) pixels in FR (RR) mode.

Note that acquisition geometry and ECMWF annotations for both resolution products are provided at tie-points on a grid defined as a 64 by 64 subset of the FR product grid. In RR mode, the tie-point grid is identical in terms of ground spatial sampling but shifted with respect to the FR grid (tie-points every 16 pixels).

3.10.3 Notations

Absorption: a measure of the ability of a surface to absorb incident energy, often at specific wavelengths.

Albedo: the ratio of the radiation reflected from an object to the total amount incident upon it, for a particular portion of the spectrum.

Detector index: index of the CCD detector (1 to 15).

Frame: the set of measurements acquired by the instrument at a given time.

Irradiance: the density of the radiant flux that is incident on a surface per unit of wavelength.

Instrument frame: a set of instrument pixels acquired at the same instant

Luminance: the quantitative attribute of light that correlates with the sensation of brightness and is the evaluation of radiance by means of the standard luminosity function.

Optical density: the logarithm to base 10 of the inverse of the transmittance.

Photon: a particle of light (or other electromagnetic radiation).

Pixel: Picture element: the set of measurements taken for a given location at a given time.

Product frame: a set of product pixels corresponding to a given satellite position.

Radiance: a measure of the energy radiated by the object together with the frequency distribution of that radiation.

Radiative transfer equation: the equation which describes the radiation passage through a scattering and absorbing medium.

Radiometer: an instrument for quantitatively measuring the intensity of electromagnetic radiation in some band of wavelengths in any part of the electromagnetic spectrum. Usually used with a modifier, such as an infrared radiometer or a microwave radiometer.

Rayleigh scattering: a form of atmospheric scattering that is caused when radiation interacts with particles whose diameter is much smaller than its wavelength. It therefore affects shorter wavelengths.

Reflectance: ratio of the intensity of reflected radiation to that of the incident radiation on a surface.

Rxxx: Water-leaving reflectance

Sample: single measurement item, i.e. a single spectral value of a given pixel.

Scattering: the process in which a wave or beam of particles is diffused or deflected by collisions with particles of the medium which it traverses.

Scattering phase function: the angular function which describes the directional scattering probability as a photon interacts with a scattering particle.

Spectrometer: a device used to measure radiant intensity or to determine the wavelengths of various radiations

3.11 Document Library

- [Sentinel-3 Optical User Test Data Set description](#)

This Technical Note is aimed at describing the Sentinel-3 Optical Test Data Sets (TDS) provided to the user community and the limitations of the TDS'. No detail on the tools used for the generation of the TDS will be provided, but only a high level description.

- [Sentinel-3 User Handbook](#)

The Sentinel-3 Mission Guide provides a high-level description of the mission objectives, satellite description and ground segment. It also covers an introduction to heritage missions, thematic areas and services, orbit characteristics and coverage, instrument payloads and data products.

- [GSC Sentinel-3 PDGS Products Definition](#)

This document is intended to provide the description of the Sentinel-3 products that will be generated within the Sentinel-3 Payload Data Ground Segment by the Sentinel-3 Instrument Processing Facilities (IPFs).

- [Sentinel-3 Product Data Format Specification - Product Structures](#)

This document aims to identify and specify the common definitions, structures and conventions of the Sentinel-3 products from Level 0 up to Level 2.

- [Sentinel-3 PDGS File Naming Convention](#)

This Technical Note provides the File Naming Convention adopted by the Sentinel-3 PDGS for the following data classes: Instrument data products, including

Level-0 products

Higher level data products

Auxiliary data

- [Sentinel-3 Product Data Format Specification - OLCI Level 1 and 2 Instrument Products](#)

This document aims to identify and specify the format of Sentinel-3 OLCI products from Level 1 up to Level 2, browse products included.

NB: The product specifications reflect the current operation processor implementation - IPF V05 - they still could be updated before launch or during the commissioning phase.

- [Sentinels POD Service File Format Specifications](#)

The purpose of this document is to define the product structure and the content of each file generated and delivered by the POD Service Centre and the Sentinel-3 NRT POD Instrument Processing Facility (IPF) across its interfaces to the Sentinels (1, 2 and 3) Payload Data Ground Segments (PDGSs).

- [Sentinel-3 OLCI Confidence Check ATBD](#)

The confidence check ATBD defines the OLCI classification flags and details of example quality flags that will provide the end users with confidence in the OLCI products.

- [Sentinel-3 OLCI Gaseous Correction ATBD](#)

This ATBD describes the impact of the relevant absorption features due to atmospheric gases within the spectral domain of OLCI. Procedures will be discussed to correct the influence of atmospheric gas absorption for those OLCI channels, which are significantly affected.

- [Sentinel-3 OLCI Pixel Classification ATBD](#)

The aim of the classification is to distinguish water and land i.e. it will be designed to separate pixels into the water and land chains as there is currently no OLCI atmospheric processing chain.

- [Sentinel-3 OLCI Ocean Colour Turbid Water ATBD](#)

This ATBD describes the algorithm for the determination of inherent optical properties (IOPs) and the concentration of water constituents in case 2 waters from water leaving radiance reflectance spectra to be used for the Ocean and Land Colour Imager (OLCI) of the Earth Observation Mission Sentinel-3 of the European Space Agency (ESA).

- [Sentinel-3 OLCI Water Vapour ATBD](#)

This ATBD describes the retrieval of water vapour from OLCI measurements above land, ocean and clouds.

- [Sentinel-3 OLCI Ocean Colour Products in Case 1 Waters ATBD](#)

The purpose of this document is to lay out algorithms for the OLCI ocean colour products in Case 1 waters.

- [Sentinel-3 OLCI Atmospheric corrections over Case 1 Waters ATBD](#)

The purpose of this document is to lay out the OLCI atmospheric correction algorithm above Case 1 waters.

- [Sentinel-3 OLCI Bright Waters Atmospheric Correction ATBD](#)

The purpose of this algorithm is to determine the correction for NIR reflectance needed for the full atmosphere correction model - applied to visible wavelengths.

- [Sentinel-3 OLCI Transparency Products ATBD](#)

The purpose of this document is to lay out algorithms for the sea water transparency products.

- [Sentinel-3 OLCI Terrestrial Chlorophyll Index ATBD](#)

This Algorithmic Theoretical Basis Document (ATBD) describes the algorithm used to estimate chlorophyll content over land from Level-1 OLCI products from the Sentinel-3 mission. The algorithm called the OLCI Terrestrial Chlorophyll Index (OTCI) is a unique chlorophyll index for OLCI data. This document identifies the source of input data; outlines the physical principles and mathematical background; justifies this algorithm and then explores its limitations and assumptions.

- [Sentinel-3 OLCI Photosynthetically Active Radiation ATBD](#)

Photosynthetically Active Radiation (PAR) reaching the ocean surface is defined as the quantum energy flux from the Sun in the spectral range 400-700 nm; units are Einstein/m²/day. PAR is essential for the carbon-cycle modellers to convert the measured chlorophyll concentration into an estimate of ocean productivity, and hence of carbon sequestration.

- [Sentinel-3 OLCI White Caps Correction ATBD](#)

The purpose of this ATBD is to define the approach to white cap correction that could be applied to OLCI.

- [Sentinel-3 OLCI Instrumental Corrections ATBD](#)

This document aims at providing a comprehensive description of the OLCI instrument's spectral characteristics and their potential impact on algorithms likely to expect data acquired at a constant wavelength.

It describes an algorithm that (a) properly accounts for the instrument spectral characterisation to convert TOA radiances into TOA reflectances and (b) provides a first order correction of the TOA reflectance for the wavelength variation, accounting for the surface underneath.

- [Sentinel-3 OLCI Glint Correction ATBD](#)

This ATBD discusses the potential approaches to correct sun glint for OLCI. The amount of sun glint will be reduced as compared to MERIS; the field-of-view (FOV) is tilted to reduce the sun-glint pollution (maximum Operating Zenith Angle, OZA, of 55°).

- [Sentinel-3 OLCI Alternative Atmospheric Correction ATBD](#)

This ATBD describes a procedure to derive the bi-directional water leaving radiance reflectances (RL_w) from top of atmosphere (TOA) radiance reflectance spectra RL_{toa} (L1b data) of the Ocean Land Colour Imager (OLCI) on Sentinel 3. The procedure is an alternative method to the standard atmospheric correction procedure for OLCI. Its main purpose is to improve the atmospheric correction over turbid and highly absorbing case 2 water and for areas of an image which are contaminated by sun glint. However, it can be applied also to case 1 water.

4 SENTINEL-3 SLSTR USER GUIDE

4.1 Introduction

The SENTINEL-3 SLSTR User Guide provides a high level description of the available instrument modes and products. It also provides an introduction to relevant application areas, information on data distribution, product formatting and software tools available from ESA.

The categories are:

- **Overview**
Giving a brief overview of the [SLSTR heritage and new instrument features](#) and describing the main characteristics in terms of [geophysical measurements](#) for sea surface and land surface.
- **Applications**
Describes the support of the SENTINEL-3 SLSTR mission to [maritime monitoring](#), [land mapping and monitoring](#), [atmospheric monitoring](#) and [climate change monitoring](#).
- **Product Types**
Describes the granularity of SENTINEL-3 SLSTR products distributed to users: [Level-1B](#) (radiance and brightness temperature), [Level-2 WST](#) (SST following the GHRSSST specifications) and [Level-2 LST and FRP](#) (Land Surface Temperature and Fire Radiative Power). The [Level-2 WCT](#) (Sea Surface Temperature (SST) for single and dual view) is not distributed to the users.
- **Processing Levels**
Illustrates the processing steps from [Level-0](#), [Level-1](#) to [Level-2](#).
- **Resolutions** and **Coverage**
Defines the [spatial](#) VNR/SWIR resolution, the TIR resolution, the [radiometric resolutions](#) and describes the [revisit frequency and coverage](#).
- **Naming Convention** and **Data Formats & Sizes**
Describes the data [naming conventions](#) used and introduces the formatting used for Level-0, [Level-1](#) and [Level-2](#) products.
- **Definitions**
Provides information on [units](#), [notations](#) and [product grids](#) used in the acquisition and processing of SLSTR products.

For an in-depth description of the mission's products and algorithms, and details of the SAR instrument and its performance, refer to the [SENTINEL-3 SLSTR Technical Guide](#). The detailed information available in the Technical Guide is focused upon users such as academics and industrial software engineers who have previous experience of similar EO missions, and in-depth experience of data manipulation and management.

4.2 Overview

The Sea and Land Surface Temperature Radiometer (SLSTR) is a dual scan temperature radiometer, which has been selected for the low Earth orbit (800 - 830 km altitude) ESA SENTINEL-3 operational mission as a part of the Copernicus (Global Monitoring for Environment and Security) programme.

The principal objective of [SLSTR products](#) is to provide global and regional Sea and Land Surface Temperature (SST, LST) to a very high level of accuracy (better than 0.3 K) for both [climatological and meteorological applications](#).

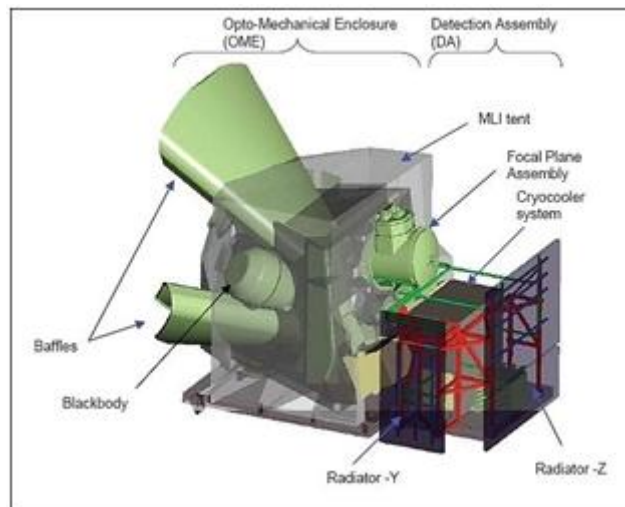

Figure 4-1: SLSTR Instrument Overview

4.2.1 Heritage

The primary mission objective of the SLSTR instrument is to extend the long-term consistent set of global [Sea Surface Temperature \(SST\)](#) measurements.

SLSTR provides data continuity back to 1991 as its data permit the continuation of data-sets from previous instruments: ATSR on ERS-1, ATSR-2 on ERS-2 and AATSR on ENVISAT.

The SLSTR design incorporates the basic functionality of AATSR, with the addition of some new, more advanced, features. These include wider swath coverage which completely overlaps the OLCI swath, more spectral bands, and a spatial resolution of 0.5 km for visible and SWIR bands. Both the SLSTR and [OLCI](#) instruments require a clear view to the sun for calibration purposes and accommodating both on the same platform resulted in the SLSTR oblique view pointing backwards. This configuration is different to the ENVISAT AATSR configuration.

In addition, SLSTR using a suite of visible and infra-red radiance measurements provides land surface temperature, active fire monitoring, ice surface temperature, cloud, atmospheric aerosol, land surface, forestry and hydrology products in support of Copernicus services.

Following ENVISAT AATSR, the [SLSTR instrument](#) is a conical scanning imaging radiometer employing the along track scanning dual view technique to provide robust atmospheric correction over a dual-view swath. The instrument includes channels in the visible (VIS), thermal (TIR) and short wave (SWIR) infra-red spectrum.

A single SLSTR provides equivalent or better performance (see comparative table below) when compared to its predecessors in the following ways.

- Increase of the dual view swath width from 500 to 740 km centred on the sub-satellite track gives a mean global coverage revisit time at the equator of 1.9 days (one spacecraft) or 0.9 days (two spacecraft).
- Enlarged single view swath width of 1 400 km provides a mean global coverage revisit time at the equator of 1 day (one spacecraft) or half a day (two spacecraft).
- An on-ground resolution of 0.5 km at nadir (instead of 1 km) for all VIS and SWIR channels. Radiance measurements from these channels are used for both land and clouds daytime observations.
- Two added channels (at wavelengths of 2.25 and 1.375 microns) in the SWIR band to allow improved cloud and aerosol detection to give more accurate SST/LST retrievals.

- Two dedicated channels for fire and high temperature event monitoring at 1 km resolution (by extending the dynamic range of the 3.7 μm channel and including dedicated detectors at 10.8 μm that are capable of detecting fires at ~ 650 K without saturation).
- A mission design lifetime of 7.5 years which is higher than that of earlier instruments.

Performance	Parameters	SLSTR	AATSR & ATSR-1/2
Swaths	Nadir view	1 400 km	500 km
	Dual view	740 km	500 km
Global coverage revisit time	1 S/C (dual view)	1.9 days	7-14 days
		0.9 days	-
		1 day	7-14 days
		0.5 days	-
SSI at SSP (km)		0.5 km VIS-SWIR 1 km IR-fire	1 km
Spectral channels centre λ (μm)	VIS (not ATSR-1): SWIR: MWIR/TIR: Fire-1/2:	0.555; 0.659; 0.865; 1.375; 1.610; 2.25; 3.74; 10.85; 12; 3.74; 10.85	0.555; 0.659; 0.865; 1.610; 3.74; 10.85; 12; -
Radiometric resolution	VIS (a=0.5%): SWIR (a=0.5%):	SNR > 20 SNR > 20	SNR > 20 SNR > 20
	MWIR (T=270K): TIR (T=270K): Fire-1 (<500 K): Fire-2 (<400 K):	Ne Δ T < 80 mK Ne Δ T < 50 mK Ne Δ T < 1K Ne Δ T < 0.5 K	Ne Δ T < 80 mK Ne Δ T < 50 mK
Radiometric accuracy	VIS-SWIR: (a=2-100%)	< 2% (BOL) < 5% (EOL)	< 5%
	MWIR-TIR (265-310K): Fire (<500k):	< 0.1 k (goal) < 3 K	< 0.1 K
Life time (in orbit)		7.5 years	AATSR: 5 year design, operative since 2002; ATSR-2: 3 year design, operating from 1995 to 2008; ATSR-1: 3 year design, operating from 1991 to 2000

Table 4-1: Comparison of SLSTR specification with respect to previous AATSR and ATSR-1/2 instrument performance.

SSI is the spatial sampling interval at sub-satellite point (SSP), λ is central wavelength, a is top of atmosphere albedo, T is top of atmosphere brightness temperature, SNR is signal-to-noise ratio, and NE Δ T is noise equivalent difference temperature.

4.2.2 Geophysical Measurements

4.2.2.1 Sea Surface Temperature

The Sea Surface Temperature (SST) measurement is obtained by means of a highly accurate calibration of the three infrared channels at 3.74, 10.85 and 12 μm (S7-S8-S9) used for correction of the water vapour atmospheric absorption (split window during day and triple window during night) and observation of the same on-ground pixel by means of two atmospheric path views for correction of aerosol effects.

Very high levels of accuracy and precision are required to support global climate monitoring and change detection. The SLSTR instrument and ground processing system are required to produce SST retrievals routinely from the

corresponding brightness temperatures with an absolute accuracy of better than 0.3 K, globally, both for a single sample and when averaged over areas of 0.5° longitude by 0.5° latitude, under certain cloud-free conditions (i.e. >20% cloud-free samples within each area). The SLSTR instrument also has a temporal stability of 0.1 K/decade.

It is important to note that the [SLSTR instruments](#) return SST measurements for the ocean 'skin' and that the temperature of the sea skin surface is typically a few tenths of a degree cooler than the temperature a few centimetres below. Due to the limited penetration of thermal infra-red radiation through the water column, the infra-red radiometric temperature is that of only the top few tens of micrometres, whereas the oceanographically understood SST is a measure of the temperature in the top 10 cm.

SST varies between -1.8°C, the temperature at which sea water freezes, and +30°C near/below the Equator. Note also that one SLSTR Level-2 product provides SST following the Group for High Resolution Sea Surface Temperature ([GHRSSST](#)) data processing specification. As a consequence, SST is given as a single field, derived from the best performing single-coefficient SST field in any given part of the swath.

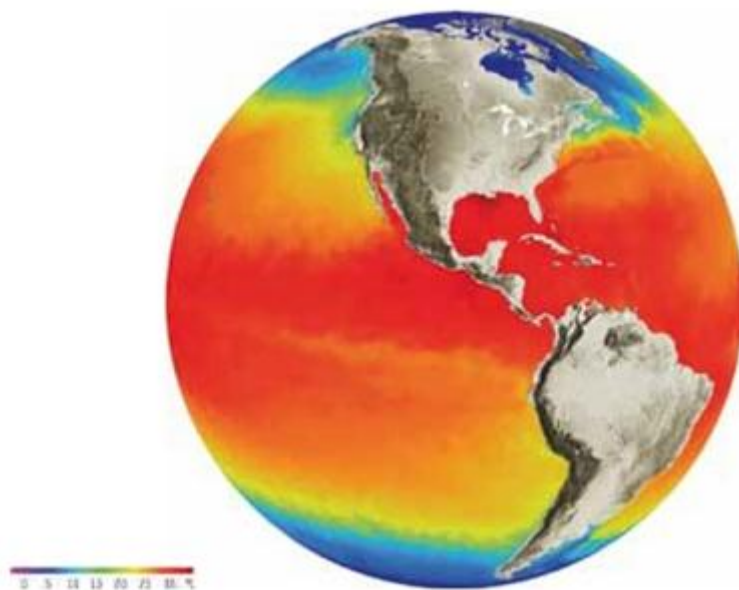

Figure 4-2: Global SST map derived from a combination of data derived from the (A)ATSR reference SST satellite instruments, in situ measurements and other satellite SST datasets. SENTINEL-3 will maintain and extend the high-quality SST measurements of the (A)ATSR series required by Copernicus and other climate services. (Credit: Met Office, UK)

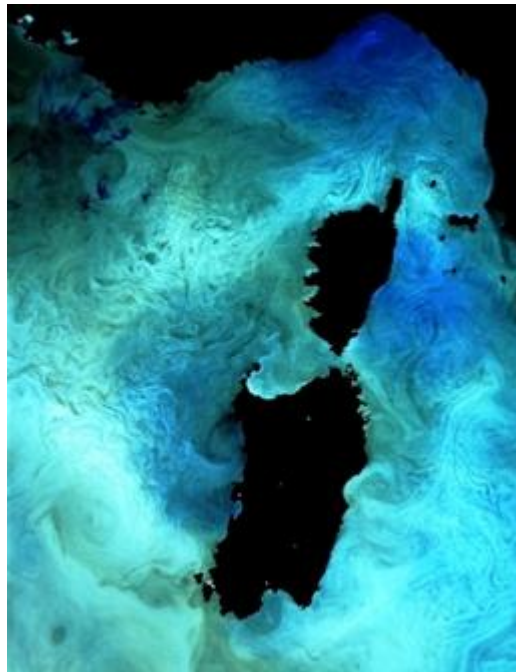

Figure 4-3: Thermal Structure Over the Mediterranean Sea (AATSR sensor)

For further information about the principles of measurements of the SLSTR , see the Technical Guide [SLSTR Instrument Description](#).

4.2.2.2 Land Surface Temperature

Land Surface Temperature (LST) is the radiative skin temperature of the land derived from solar radiation. A simplified definition would be how hot the "surface" of the Earth would feel to the touch in a particular location. From a satellite's point of view, the "surface" is whatever it sees when it looks through the atmosphere to the ground. It could be snow and ice, the grass on a lawn, the roof of a building or the leaves in the canopy of a forest. Land surface temperature is not the same as the air temperature that is included in the daily weather report.

In the SLSTR project, "skin" temperature refers to the temperature of the top surface in bare soil conditions and to the effective emitting temperature of vegetation "canopies" as determined from a view of the top of a canopy. LST is a basic determinant of the terrestrial thermal behaviour, as it controls the effective radiating temperature of the Earth's surface. However, because of the extreme heterogeneity of most natural land surface, this parameter is difficult to estimate and validate. Several factors can fundamentally influence the derivation of LST including:

- temperature variations with angles
- sub-pixel in-homogeneities in temperature and cover
- surface spectral emissivity at the channel wavelengths
- atmospheric temperature and humidity variations
- clouds and large aerosol particles such as dust.

The SLSTR thermal bands used for SST retrieval (the three infra-red channels S7, S8 and S9 at 3.74, 10.85 and 12 μm) are also available over land and are used to retrieve LST in the SLSTR Level-2 products. Algorithms for deriving LST using split-window radiances are sufficiently advanced that accuracy of 1 K is possible (especially at night when differential surface heating is absent).

SLSTR also includes two low-gain, wide-dynamic range IR (fire and high temperature) channels (F1 and F2) designed to deliver the radiometric data necessary for the generation of quantitative active fire products. This prevents saturation of the thermal channels and applies to targets with an upper limit of 500°C.

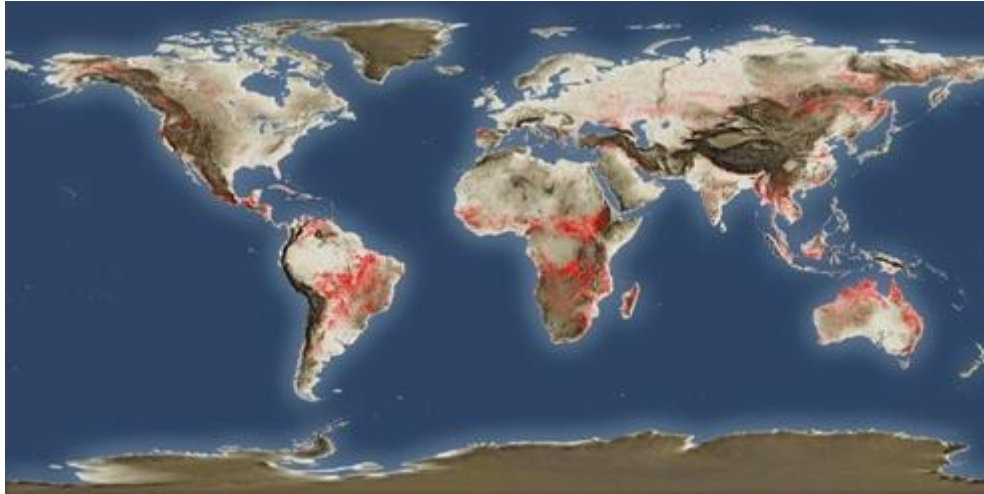

Figure 4-4: Distribution of fire hotspots derived from the (A)ATSR instruments (ESA ATSR World Fire Atlas). SENTINEL-3 provides an enhanced fire-monitoring capability compared to AATSR. (Credit: ESA)

For further information about the principles of measurements of the SLSTR, see the Technical Guide [SLSTR Instrument Description](#).

4.3 Applications

SLSTR is the successor of the (A)ATSR series (aboard ERS and ENVISAT missions) and as such provides many applications within which [Sea Surface Temperature \(SST\)](#) sensing is probably the most emblematic. [Land monitoring](#) is also an important aspect of SLSTR. In addition to this heritage, new technological features of the instrument allow expanding the application to biomass burning ([fire detection and classification](#)). It should also be noted that SLSTR contributes to [climate studies](#) by bringing several of the required Essential Climate Variables (ECVs) to the scientific community.

For further information about applications and services available, see: [Copernicus website](#).

4.3.1 Maritime Monitoring

Two SLSTR products are highly relevant to marine applications. These are:

- [sea surface temperature](#)
- [sea-ice temperature](#).

4.3.1.1 Sea Surface Temperature

SST is not only one of the most famous but also one of the most important climate variables, with a solid background of measurements and analysis. By having such historical records available, SST is a vital climate change variable for marine science. It is used in NRT (less than 3 hours after measurement by satellite) for modelling forcing, front detection and SST surface patterns that report the hydrodynamic structure of the ocean upper level.

4.3.1.1.1 Climate

Climate prediction research and climatology is motivated by the continuous enhancement of reliable climate prediction uncertainty. This is supported by strategic advancement through input and advice to climate change assessments. SST is needed in the framework of climate model initialisation, diagnostics and fundamental climate monitoring. The most important requirement is that the observations are accurate and unbiased. Considering the best estimates of global warming trends, SST data sets should be exceptionally stable to better than 0.1 K/decade if with a mean zero bias.

Nowadays, thanks to satellite measurements, scientific teams have access to a unique and extensive source of global coverage SST observations. A very highly valued contribution to climate research is the GHRSSST-PP, as a result of the GHRSSST-PP Re-analysis programme (RAN). RAN is working to create an SST Climate Data Record (CDR) encompassing all satellite records (from approximately 1984). SST acquisition by the SLSTR plays an important role in building this CDR long time series.

4.3.1.1.2 Numerical Modelling

Since SST patterns change relatively slowly, they can be well predicted: in some areas of the world, up to 6 months ahead or longer. The relationships between regional SST patterns and the atmosphere can either be shown thanks to numerical models of the atmosphere and ocean or statistically connected to SST observations or data-driven analysis. A lot of seasonal prediction systems are based on dynamically coupled climate models. SST patterns and seasonal weather trends are strongly related, especially in the tropical regions. Strong signals are connected to the El Niño phenomenon in the tropical Pacific, about every three or four years, which can distort the global patterns of normal weather, modifying, by instance, seasonal rainfall patterns (floods in some area and droughts in others). In other areas of the world, weaker connections between SST and seasonal weather are established.

4.3.1.1.3 Meso-Scales Analysis

Daily maps of SST show thermal front location and intensity, often utilised for several applications. For instance, SST maps, combined with other information (sea surface height maps, phytoplankton) are utilised to aid catching of some fish species at different levels of the trophic chain. Thanks to surface thermal front, navies and researchers can improve their understanding and qualification of the vertical structure of the water mass and the internal wave propagation. As cold water upwelling from the sea bottom bringing up nutrients to upper layers, large ecosystems are also very well detected by SST signatures. This supervision is essential for a better assessment of variability of such ecosystems and possible fish stocks and levels of recruitment. Recently, statistical hurricane models also widely incorporate SST analyses for anticipating tropical cyclone intensity.

SST is one of the most important products regularly delivered to the GMES Service Element (Marcoast) user community and for European research projects within the remit of Copernicus.

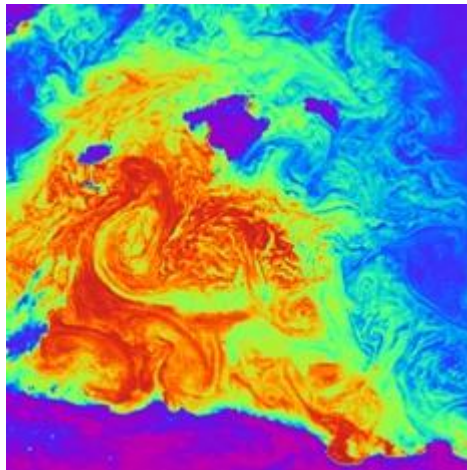

Figure 4-5: AATSR SST images: in this night-time image, the coldest areas - which include all the land - are shown in purple and blue, whilst yellow and orange are used to represent successively warmer temperatures over a total range of 280-295 K. The three blue-purple islands in the top half of the image are the Balearics and the land at the bottom of the picture is the north coast of Algeria. Eddy structures ranging in size from less than 10km to nearly 100km decorate the entire sea area. Note that the warmest water appears to originate from the Gulf de Béjaïa on the Algerian coast. (Credit: RAL)

For further information about marine applications and services available, see: [Copernicus website](#).

4.3.1.2 Ice Surface Temperature

Sea-ice is found in remote polar oceans. It spreads over approximately 25 million square kilometres of the Earth, i.e. two-and-a-half times the extent of Canada. It is a crucial part of the planet, even though it might not directly affect people, since it does have an effect on climate, wildlife and on people who live in the Arctic.

Sea-ice is frozen ocean water. It forms, grows and melts in the ocean. By contrast, icebergs, glaciers, ice sheets and ice shelves all arise from land. Monitoring the temperature of sea-ice is the same as monitoring its appearance, its morphological characteristics and its collapse.

Although sea-ice mainly appears in polar regions, it does have an impact on global climate. The bright surface of sea-ice reflects much of the sunlight that strikes it, back into space. Parts that are covered by sea-ice cannot absorb much solar energy and temperatures in the polar regions stay fairly cool. In the case of gradually warming temperatures, melting sea-ice over time, the bright surface becomes smaller and less sunlight is reflected back into space. As a consequence, more solar energy is absorbed at the surface resulting in further increases in temperature. This sequence of events is temporarily paused when the dark days of the polar winter return, but starts again in the following spring. Polar regions are the most susceptible areas to climate change since even a small change in temperature can result in a greater warming over time.

The movement of ocean waters is also affected by sea-ice. Normal ocean circulation can be altered by a change in the amount of sea-ice, leading to global climate change.

In addition, a proportion of sea-ice is required for wildlife and people who hunt or travel in polar regions. Sea-ice can obstruct or impede normal shipping routes through the northern sea route and Northwest Passage in the Arctic.

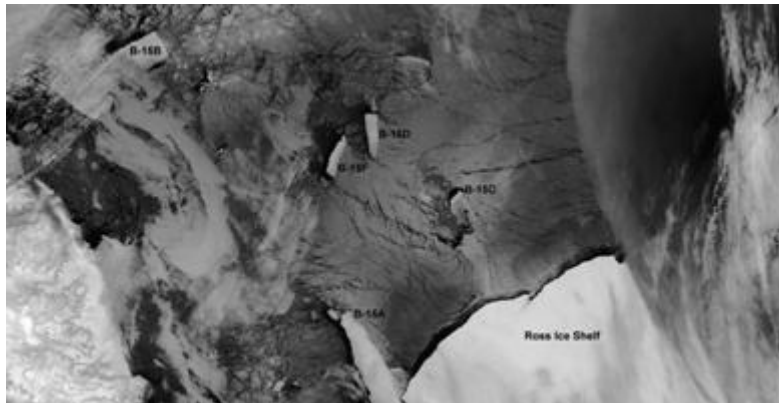

Figure 4-6: micron Thermal Image (ATSR-2, April 2 2001) Showing Continued Break-Up of the B-15 Iceberg (Ross Sea). (Credit: RAL)

For further information about ice applications and services available, see: [Copernicus website](#).

4.3.2 Land Monitoring

Three types of SLSTR products are fundamental for land applications:

- [land surface temperature](#)
- [fire location and fire radiative power](#)
- [vegetation index](#).

For further information about land applications and services available, see: [Copernicus website](#).

4.3.2.1 Land Surface Temperature

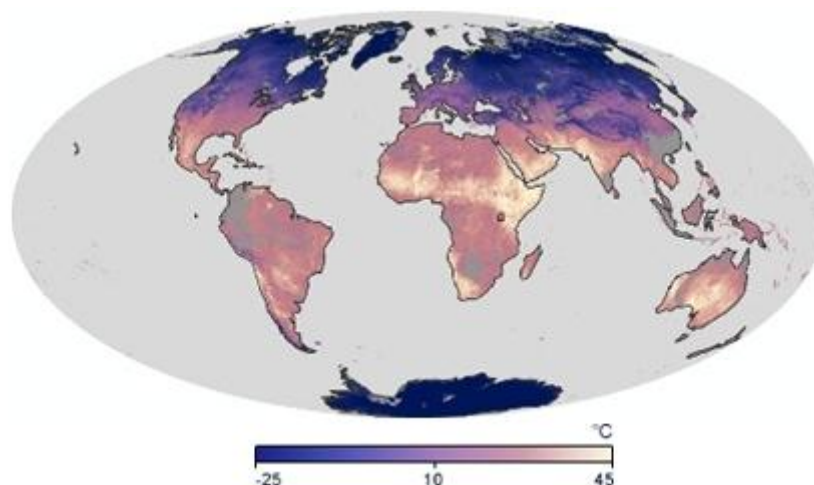

Figure 4-7: Land Surface Temperature from MODIS Data (February 2000 - August 2012) (Credit NASA)

Warmth coming off the Earth's sites affects (and is affected by) the world's weather and climate patterns. A good indicator of this phenomenon is the land surface temperature. Scientists aim to study how rising land surface temperatures

influence glaciers, ice sheets, permafrost and the vegetation in the Earth's ecosystems and how increasing atmospheric greenhouse gases affect land surface temperature.

Land surface temperature maps are also used for commercial agricultural purposes to evaluate water requirements during summer periods when crops may be exposed to heat stress or, in contrast, during winter periods, when crops and trees may be exposed to damaging frost.

For further information about land applications and services available, see: [Copernicus website](#).

4.3.2.2 Fire Location and Fire Radiative Power

The significance of large scale fire activity in various parts of the Earth system has been featured by Bowman *et al* ^[11]. By destroying vast amounts of vegetation, large scale fire activity acts as a widespread change agent. These changes can also affect land surface properties or land cover types, and are also associated with a release of large amounts of trace gases and aerosols. As a consequence, worldwide grasslands, forests and peatland fires greatly impact large-scale ecosystem patterns and processes, carbon storage, atmospheric composition and climate ^[12].

Rises in carbon emissions from fires are substantial, for example 2.0-3.2 Pg C year⁻¹ in 1997-2004 ^[13] compared to ~7.2 Pg C year⁻¹ in 2000-2005 from fossil fuel combustion ^[14]. On average, it is estimated that approximately 30% of global total CO emissions, 10% of methane emissions, 38% of tropospheric ozone and over 86% of black carbon are produced by fires ^[12]. Changes of weather and climate (inter-annual climate variability and long-term climate change) have an effect on a vegetation fire's frequency, size, intensity and severity. Noticed variations in inter-annual atmospheric greenhouse gas growth rates are likely linked to year-to-year variations in global fire activity (for instance, the two thirds increase of CO₂ observed between 1997 and 2001 ^[13]).

A potential response to climate changes seems to be the increasing extent of biomass burning activity in certain parts of the world ^[15] ^[16]. The unpredictable nature of fire and this inter-annual variability makes SLSTR data important for research, through detecting and quantifying actively burning fires through their emitted radiation signals ^[2]. In order to support both Global Monitoring for Environment and Security (Copernicus) operational services and scientific applications, fire detection and fire radiative power have been included in the SLSTR land product. SLSTR measurements from near-nadir scan are inputs for the fire product algorithm.

¹¹ Bowman, D. M., Balch, J. K., Artaxo, P., Bond, W. J., Carlson, J. M., Cochrane, M. A., et al. (2009). Fire in the earth system. *Science*, 324, 481-484.

¹² Lavorel, S., Flannigan, M., Lambin, E., & Scholes, M. (2007). Vulnerability of land systems to fire: Interactions among humans, climate, the atmosphere, and ecosystems. *Mitigation and Adaptation Strategies for Global Change*, 12, 33-53.

¹³ Van der Werf, G. R., Randerson, J. T., Giglio, L., Collatz, G. J., & Kasibhatla, P. S. (2006) Inter-annual variability in global biomass burning emission from 1997 to 2004. *Atmospheric Chemistry and Physics*, 6, 3423-3441.

¹⁴ Alley, et al. (2007). Fourth assessment report of the IPCC. The physical science basis, Working Group I report.

¹⁵ Running, S. (2006). Is global warming causing more, larger wildfires? *Science*, 313, 927, doi:10.1126/science.1130370.

¹⁶ Westerling, A. L., Hidalgo, H. G., Cayan, D. R., & Swetnam, T. W. (2006). Warming and earlier spring increase Western U.S. forest wildfire activity. *Science*, 313, 940-943, doi:10.1126/science.1128834.



Figure 4-8: RGB image of forest fires. The image was obtained from ATSR-2's nadir view, during a day-time pass of the northwest American states of Idaho and Montana. In this representation there is a clear distinction between the cloud (white) and the smoke from the fires (blue), whilst forested areas appear green.

For further information about land applications and services available, see: [Copernicus website](#).

4.3.2.3 The Vegetation Index

The vegetation index, also known as the Normalised Difference Vegetation Index (NDVI) is also available from other missions and is included in the SLSTR products. This parameter is useful in monitoring the phenology state of vegetation or for detecting possible desertification trends. This may also be used as additional information on land surface temperature to support precision farming.

For further information about land applications and services available, see: [Copernicus website](#).

4.3.3 Atmospheric Monitoring

Studying aerosols can be useful in several scientific subjects, including radiative transfer, cloud formation, air quality, visibility, atmospheric stability, the hydrological cycle, human health and especially, climate change. The concept of aerosol-radiation-climate interactions was first developed around 1970. Since then and especially over the past 10 years, the determination of mechanisms and magnitudes of these interactions have considerably progressed. Recently, extensive field experiments associated with ground-based network measurements, satellite remote sensing and its integration with model simulations have substantially improved the characterisation of aerosols.

According to the Intergovernmental Panel on Climate Change (IPCC), the role of aerosols in climate is one of the biggest uncertainties in understanding the current climate system and in predicting further climate change^[17]. Because of spatial and temporal variability, the establishment of the mechanism of aerosol direct effects is more challenging. Insufficient

¹⁷ Chylek, P, Henderson, B, Mishchenko, M., 2003. Aerosol radiative forcing and the accuracy of satellite aerosol optical depth retrieval J GEOPHYS RES-ATMOS 108 (D24), 4764, doi:10.1029/2003JD004044.

comprehension of the distribution and physical and chemical properties of aerosols and aerosol-cloud interactions leads to significant uncertainties in current estimates of aerosol forcing ^[18].

From both the observational and modelling point of view, aerosol indirect effects on clouds represent a huge challenge. Because of the advancement in satellite and modelling techniques, recent studies were able to concentrate on the estimation of the aerosol indirect radiative forcing. For instance, thanks to the comparison between forward and inverse model calculations, Anderson *et al*, (2003) ^[19] suggest an overestimation of this forcing in current climate models. In addition, Quaas and Boucher (2005) ^[20] evaluate and improve the representation of the Aerosol Indirect Effect (AIE) in a general circulation model by:

- deriving statistical relationships of cloud-top droplet radius and aerosol index (AOD) using MODIS and POLDER data from satellite retrievals
- fitting an empirical parameterisation in a general circulation model to suit the relationships.

The inverse calculation is coherent with their result on the aerosol indirect radiative forcing effect ^[19].

Current knowledge of cloud dynamic and radiative properties is known and accepted to be insufficient for modern climate analysis and prediction schemes. This results from high spatial and temporal variability of aerosol loading and from a complex link between aerosols and cloud properties. As a consequence, the total aerosol forcing of the climate system remains indeterminate.

As well as affecting the global climate, aerosols have an impact on the climate of certain regions and their water cycle. Concerning SLSTR and the retrieval of surface temperature, the first practical priority is to detect the presence of clouds. Once this objective is satisfied, SLSTR's multi-angle multi-wavelength viewing geometry can be used to characterise and investigate the properties of clouds.

The development of operational SLSTR cloud product is recommended to be supported and implemented (as it was suggested in [AATSR Exploitation Plan - vol. 6](#)). These products, including cloud optical depth, cloud phase, cloud particle size, cloud top pressure, cloud fraction and cloud water path, need to be supported by accurate validation activities.

For further information about marine applications and services available, see: [Copernicus website](#).

4.3.4 Climate Change Monitoring

Deriving products and data records of several physical variables from satellite measurements has been highly recommended by the 2010 Update of the Implementation of Plan for the Global Observing System for Climate in Support of the UNFCCC1 (GCOS-138, August 2010; the 'IP-10' - WMO, 2010). These variables are defined as Essential Climate Variable (ECV).

Following this recommendation, two products from SLSTR contribute to the Global Observing System for Climate, providing the following parameters.

¹⁸ Yu, H., Y. J. Kaufman, M. Chin, G. Feingold, L. Remer, T. Anderson, Y. Balkanski, N. Bellouin, O. Boucher, S. Christopher, P. DeCola, R. Kahn, D. Koch, N. Loeb, M. S. Reddy, M. Schulz, T. Takemura, and M. Zhou, 2006: A review of measurement-based assessments of aerosol direct radiative effect and forcing. *Atmos. Chem. Phys.*, 6, 613-666.

¹⁹ Anderson, T. L., R. J. Charlson, S. E. Schwartz, R. Knutti, O. Boucher, H. Rodhe, and J. Heintzenberg (2003). Climate forcing by aerosols-A hazy picture, *Science*, 300, 1103– 1104.

²⁰ Quaas, J., and O. Boucher (2005), Constraining the first aerosol indirect radiative forcing in the LMDZ GCM using POLDER and MODIS satellite data, *Geophys. Res. Lett.*, 32, L17814, doi:10.1029/2005GL023850.

- **Sea Surface Temperature (SST)** remains an essential input for the understanding of the climate system on different time scales. This knowledge is needed for several applications: validation of climate-model, initialisation and constraint of seasonal and decadal prediction systems, computation of air sea fluxes of heat, moisture, gas and momentum, estimation of net air-sea flux of carbon, monitoring of marine biodiversity and habitat properties.
- Burned area, active fire detection and Fire Radiative Power (FRP) datasets are components of **Fire Disturbance**. Active fire methods provide more possibilities than those offered by 'burned area' maps: detection and quantification whilst a fire is still burning. It also permits the possibility of assessing the fire's rate of radiative heat release (i.e. the FRP, related to the rate of fuel consumption and smoke emission).
- Even if **Land Surface Temperature (LST)** is not considered an ECV, its high value in the determination of surface energy, water fluxes and interpretation of surface characteristics make this parameter essential in the "Global Observation System for Climate". Indeed, the nature of the diurnal temperature variations is linked to vegetation and moisture characteristics of the land surface. As a consequence, the LST derived from SLSTR measurements support the generation of land ECVs (see product T.12 in [Systematic observation requirements for satellite-based data products for climate](#)).
- Even if they are minor constituents of the atmosphere by mass, **atmospheric aerosols** have a major impact on climate, and particularly on climate change. By scattering and absorbing radiation, aerosols have a direct influence on global radiation balance and an indirect impact on cloud reflectivity, cloud cover and cloud lifetime. Anthropogenic aerosols have been identified as the most uncertain climate forcing constituent by the IPCC. The aerosols ECVs are built on by gathering (not exclusively, but mainly) information on aerosol optical depth, light scattering and absorption coefficients, aerosol size distribution and vertical distributions of aerosol backscattering and extinction. Although it is not a core product in the ground segment specification, SLSTR has been designed to provide information on Aerosols Optical Depth (AOD).

For further information about climate applications and services available, see: [Copernicus website](#).

4.4 Product Types introduction

The SLSTR product types are divided in four main products which are disseminated to users except the [Level-2 WCT product](#).

- One labelled as [Level-1B product](#) and output by SLSTR Level-1 processing. The Level-1 product provides radiances and brightness temperatures for each pixel in the instrument grid, each view and each SLSTR channel, plus annotations data associated with SLSTR pixels.
- Four labelled as Level-2 products and output by SLSTR Level-2 processing:
 - [Level-2 WCT product](#) (not disseminated to users) providing the sea surface temperature for single and dual view, for two or three channels
 - [Level-2 WST product](#) providing L2P sea surface temperature, following the GHRSSST specifications
 - [Level-2 LST and FRP products](#) providing land surface temperature and fire radiative power.

For further information about SLSTR products, see the Technical Guide [Level-1 products](#) or [Level-2 products](#).

4.4.1 Level-1B

SLSTR Level-1 processing is divided into three different modes:

- calibration processing mode
- observation processing mode
- joint mode.

The SLSTR Level-1B product is generated during observation and joint processing mode.

The SLSTR Level-1B product gathers, for each view and for each channel, the full-resolution geolocated radiometric measurements.

For thermal IR and fire channels (labelled as S7 to S9 and F1, F2 for fire channels), the radiometric measurements are expressed in Top Of Atmosphere (TOA) brightness temperatures. In the case of visible / NIR / SWIR channels (labelled as S1 to S6 channels), these measurements are expressed in TOA radiances.

The radiometric measurements are indexed according to the across track and along track direction:

- on a 1 km grid for brightness temperature
- on a 0.5 km grid for radiances. In this case, three stripes are distinguished: A, B and TDI, with TDI a derived product from A and B stripes. Only the stripes selected in the processing configuration file are available.
-

The SLSTR Level-1B product also contains:

- quality flags concerning cloud flagging and scan and flip mirror testing
- surface pixel classification information
- meteorological annotations
- quality annotations, such as estimates of detector noise measured at VISCAL or black bodies
- in the frame of coming evolutions, one file gathering parameters computed during stray light correction could be added
- arrays of indices to retrieve the position of each pixel in the instrument measurement frame
- cartesian and geodetic coordinates associated with the radiometric measurements and to the tie-points grid defined for SLSTR.

4.4.2 Level-2 WCT

The Level-2 WCT product (not disseminated to users) gathers Sea Surface Temperature (SST) on single and dual view, derived from weighted combinations of brightness temperatures measured in nadir and oblique thermal channels:

- 1 km N2 SST dataset is performed using nadir single view and only two thermal channels (channels S8 and S9, i.e. 10.85 and 12 μm) during day-time retrieval
- 1 km N3 SST dataset is performed during night-time retrieval using across track single view and all thermal channels (included S7, i.e. 3.7 μm)
- 1 km N3R SST dataset is similar to N3 but using the property of "aerosol robustness" and its associated method described by Merchant *et al* (1999)
- 1 km D2 SST dataset is similar to N2, except that dual view (across and along track) is used
- 1 km D3 SST dataset is similar to N3, except that dual view is used.

These five SST measurement datasets are generated on the wide 1 km measurement grid and indexed by across track and along track dimensions. In addition to SST, the Level-2 WCT provides the SST uncertainties and exception flags derived from SLSTR Level-1 product.

The Level-2 WCT also includes parameters directly taken from SLSTR Level-1 product, associated to re-gridded and orphan pixels:

- quality flags concerning cloud flagging and scan and flip mirror testing
- arrays of indices to retrieve the position of each pixel in the instrument measurement frame and their time stamps
- cartesian and geodetic coordinates associated to the radiometric measurements and to the tie-points grid defined for SLSTR
- meteorological annotations.

4.4.3 Level-2 WST

The SLSTR Level-2 WST product respects the Group for High Resolution Sea Surface Temperature ([GRHSSTL2P](#) specification, and includes a single SST field derived from the best performing single-coefficient SST field in any given part of the swath, plus a number of supporting data fields providing context for the SST fields.

Each SST, previously generated during the SLSTR Level-2 algorithm or contained in the Level-2 WCT product, is atmospherically smoothed following the AATSR model. The "best" product for the local conditions is then forwarded to the output field.

All the variables are gathered in one measurement file, called the 1 km L2P SST measurement dataset, generated on a wide 1 km measurement grid.

This file, indexed by across track and along track dimensions and by reference time, provides for each thermal SLSTR channel:

- the latitude and longitude coordinates of each pixel
- the SST value
- the SST time deviation from reference time and from analysis field
- the Single Sensor Error Statistic (SSES) bias and standard deviation estimate
- several contextual parameters (wind speed at 10 m, the fractional sea-ice contamination, the aerosol contamination indicator for each pixel) with the time difference between the SST and these data measurements
- a quality flag (gathering information about sensor and surface type, geographical contamination, problems during processing, Level-1B flags) and a quality indicator (from 0, default value unknown quality, 1, excellent quality to 3, extremely suspect) for SST.

Some parameters are also included in this file if a user-dependent switch, included in the SLSTR Level-2 configuration file, is set to '1'. These are:

- satellite zenith angle of each pixel and each reference time
- associated Top Of Atmosphere (TOA) Brightness Temperature (BT)
- associated TOA noise equivalent BT
- SST total uncertainty.

4.4.4 Level-2 LST and FRP

The SLSTR Level-2 LST and FRP product provides land surface parameters generated on the wide 1 km measurement grid. It contains:

- one measurement file with Land Surface Temperature (LST) values with associated parameters (LST parameters are computed and provided for each pixel (re-gridded or orphan) included in the 1 km measurement grid)
- one measurement data file with Fire Radiative Power (FRP) values and associated parameters (FRP parameters are given only for each hotspot found on the 1 km measurement grid). The FRP is computed in accordance with a processing switch (off by default).

This product also gathers 10 annotations files derived from Level-1 product.

The two measurement datasets (MD) are indexed by across track and along track dimensions and include:

- In 1 km LST MD
 - for each gridded pixel:
 - The LST values and their estimated total uncertainties
 - The exception flags associated to LST.
 - the same parameters are provided for each orphan pixel.

- In 1 km FRP MD, if the switch is set to '1'
 - for each gridded pixel:
 - fire list index
 - fire test summary flags.
 - for each detected hotspot:
 - FRP and its total uncertainty
 - TCWV above fire
 - transmittance
 - projected area of detector IFOV on surface
 - glint angle (i.e. the angle between nadir view and specular direction)
 - associated across and along track coordinates
 - time and geographical coordinates
 - fire detection confidence
 - hotspot classification code
 - background window size.

Note that, following coming evolutions, the content of the FRP file could be modified but it is not specified yet.

One Annotation DataSet (ADS) is specifically associated with LST MD and provides, for each gridded pixel and orphan pixel:

- Normalised Difference Vegetation Index (NDVI)
- GlobCover surface classification code (noted biome)
- fractional vegetation cover
- total column water vapour.

A validation status for each biome class is also provided.

Except for the quality ADS, each ADS included in the Level-1B product, associated with the 1 km grid and the nadir view or associated to the tie-point grid are copied in this product as ADS.

4.5 Processing Levels

The SLSTR operational processor is divided in to three major processing levels.

- [Level-0 processing](#) aims to extract and check the raw data contained in the instruments source packets. These data are time sorted and annotated. The Level-0 products are internal products, not disseminated to SENTINEL-3 users.
- [Level-1 processing](#) uses Level-0 products to compute radiometric measurements for each SLSTR channel in both views. This includes radiometric calibration for thermal and solar channels, several tests concerning surface and cloud flagging, and the determination of pixels' properties such as day/night, position in the instrument grid or geographical position.
- [Level-2 processing](#) uses Level-1 products (measurements and annotations data files) to computed sea surface temperature, land surface temperature and fire radiative power. Annotations associated with each pixel/channel/view are verified and gathered in the Level-2 products.

4.5.1 Level-0

Level-0 processing aims to generate Level-0 products, i.e. time-sorted and annotated data from Instrument Source Packets (ISPs). Level-0 products are internal products and are not available to SENTINEL-3 users.

The first part of the process involves unpacking the ISPs, performing a quality check and appending annotation data to them. Once the input raw data files are read, all necessary data are extracted and parsed. The ISPs are sorted and checked for missing and duplicated packet numbering.

The final part of the process is Level-0 product generation. Several quality flags are computed and included in the associated metadata and the raw data, time-sorted and annotated are included in the Level-0 package. Several objectives must be achieved by Level-0 processing.

- Leap second management should be handled.
- Product quality flags should provide information concerning nominal processing, satellite manoeuvre, contingency processing, degraded processing and the total number of missing ISPs should be reported.
- No duplicate packets should be included in Level-0 products.

4.5.2 Level-1

SLSTR Level-1 processing is divided into two processing modes corresponding to two specific branches:

- Level-1 calibration processing (S1-L1CAL), corresponding to the calibration processing mode
- Level-1A and Level-1B processing (S1-L1a and S1-L1b), corresponding to the observation processing mode.

Level-1 calibration processing aims to produce the VISCAL ADF of an orbit N. This file is then used to calibrate numerical counts from solar channel measured during orbit N+1.

The numerical counts measured by the VISCAL target, during the full illumination window (i.e. near the South Pole) are extracted and verified. Several parameters such as gain and offset for the calibration period are computed and gathered in one file.

The observation processing mode is divided into three main processes.

The first process, Level-1A processing, aims to compute ortho-geolocation of each instrument pixel and to compute radiometric calibration coefficients. It contains five main steps:

1. Source Packet Processing: unpacking, validating and converting source packet data and ancillary parameters.
2. IR Channel Calibration: calculating the calibration offset and slope that describes the linear relationship between numerical counts and radiance (focusing on thermal and fire channels).
3. Visible/NIR/SWIR Channel Calibration: similar to Level-1 calibration processing.
4. Time Calibration: computing the time stamp of each pixel.
5. Geolocation: computing the longitude/latitude/altitude and the corresponding (x,y) coordinates of each instrument pixel.

The second process, Level-1B processing, aims to calibrate and re-grid the SLSTR measurements, compute the TDI averaged pixel for SWIR channels and test each pixel for cloud presence. It contains nine main steps:

1. Signal Calibration for thermal and solar channels using the calibration coefficients derived from Level-1A processing. An empirical Stray light correction model to the SLSTR LWIR brightness temperature is expected to be implemented in coming evolutions.
2. Time Domain Averaging: computing an average of A and B stripes to generate a reduced-noise grid.
3. Re-gridding: determining, for each instrument pixel, its indices in across and along track direction taking into account a 1 km grid for thermal IR channels or a 0.5 km grid for visible, NIR and SWIR channels.
4. Cosmetic Filling: filling missing image pixels as well as some parameters needed for further sections.
5. Surface Classification and Cloud flagging are applied to each image pixel. In the future it will be improved to ensure a well-behaviour in the FRP and AEROSOL processing module.
6. Reflectance to Radiance Conversion.
7. Tie point interpolation: delimitate rectangular SLSTR L1b image and increase the tie point resolution in along-track direction (1 km instead of 16 km)
8. Meteorological Annotations Computation: providing ECMWF variables on a sub-grid of tie-points.
9. Product Formatting: aiming to identify the variables included in SLSTR product files and metadata.

4.5.3 Level-2

SLSTR Level-2 processing is divided into three main sub-chains, each activated by a specific switch included in the configuration parameters:

- SST / L2P processing (divided respectively into two independent processes)
- LST processing
- FRP processing.

In addition to these main processes:

- a section is dedicated to checking Level-1B files and auxiliary files to verify their presence and self-consistency
- a common section gathers general functions such as deriving pixel-by-pixel estimates of radiance, BT, radiance uncertainty and BT uncertainty for channels S2, S3, S6 to S9, F1 and F2
- a product formatting section populates and writes out the product metadata and data fields.

SST/L2P processing includes two independent processes:

- The Sea Surface Temperature (SST) processing module which implements five single-algorithm SST algorithms. Each derives SST as weighted combinations of the brightness temperatures measured in both view (nadir and oblique) and by the thermal channels (S7 to S9).
- The L2P processing module which implements the Level-2 SST product following the Group for High Resolution Sea Surface Temperature ([GHRSSST](#)) data processing specification. This SST field is a composite of the single-algorithm SST variables generated in the previous module. Each SST is atmospherically smoothed following the ATSR model. Only the "best" product for the local conditions is taken into account for outputting.

LST processing includes a split-window method, using radiances from two channels whose band centres are close in wavelength, to determine the effective radiometric temperature of the Earth's surface "skin" in the instrument field of view ("skin" referring to the top surface in bare soil conditions and to the effective emitting temperature of vegetation "canopies" as determined from a view of the top of a canopy). This method assumes that the linearity of the relationship between LST and BT results from linearisation of the Planck function and linearity of the variation of atmospheric transmittance with column water vapour amount.

FRP processing is a six-stage process:

1. Cloud-free land pixels which pass both spatial and spectral filter tests are considered as potential fire pixels.
2. Scenes surrounding potential fire pixels are characterised.
3. Pixels which pass either absolute or contextual tests are confirmed as fire pixels.
4. Confirmed fire pixels are screened for false alarms (caused by sun glint or desert signals).
5. Fire radiative power is computed.
6. FRP uncertainty and detection confidence are computed for each fire pixel.

However, coming evolutions are planned. The updated algorithm is not specified but will be mainly based on the one implemented in the SLSTR Level 2 prototype, so mainly based on this six-stage process.

Note also that modules of cloud detection will be added over ocean and Land pixels (respectively Bayesian and simplified Bayesian techniques).

4.6 Resolutions

The SLSTR products (Level-1B and Level-2 measurement, annotation and auxiliary datasets) are generated separately in two instrument views and at two resolutions, depending on optical channels.

- [500 m resolution](#) for solar reflectance bands
- [1 km resolution](#) for thermal infrared bands.

4.6.1 Spatial

4.6.1.1 500m (VNIR/SWIR)

The visible and ShortWave Infra-Red (SWIR) channels S1 - S6 are collected and stored at 500 m resolution. The SLSTR detectors are located in a Focal Plane Assembly (FPA). The figure below shows the relative orientations and nominal sizes of the SLSTR nadir view detector Instantaneous Fields Of View (IFOVs) at the sub-satellite track position. The X-axis is the nadir scan direction, the Y-axis is the direction of flight and O is the principal ray. The rightmost four detector elements (blue with a solid outline) are implemented in all six channels, while the remainder (green with a dashed outline) are only present in channels S4 - S6.

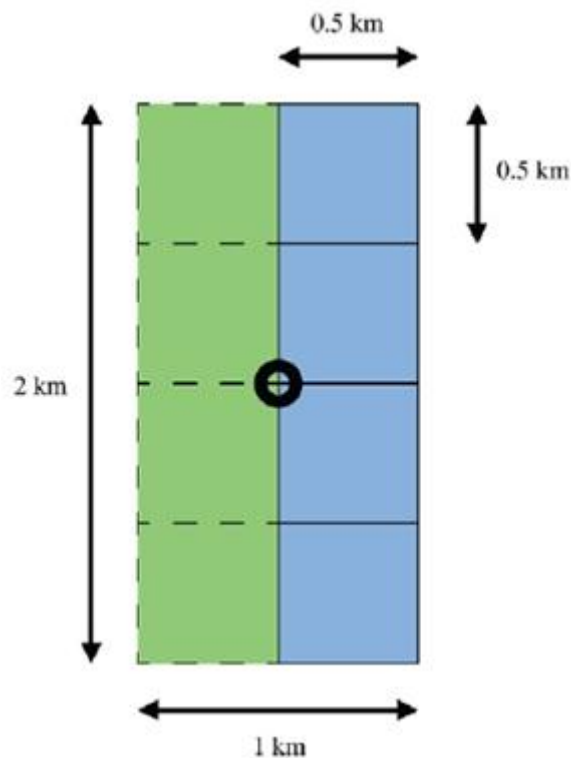

Figure 4-9: SLSTR Detector Configuration 500 m Spatial Resolution Channels S1 - S6 (VIS/NIR to SWIR)

4.6.1.2 1km TIR

Thermal infra-red channels S7 - S9, F1 and F2 are collected and stored at 1 km resolution. Each channel has two detectors, aligned along track at the sub-satellite point.

As shown in Figure 1 below, the leftmost detector elements (yellow) are common to channels S7 - S9 and F2, while the remaining detector elements (red) are used in channel F1 only.

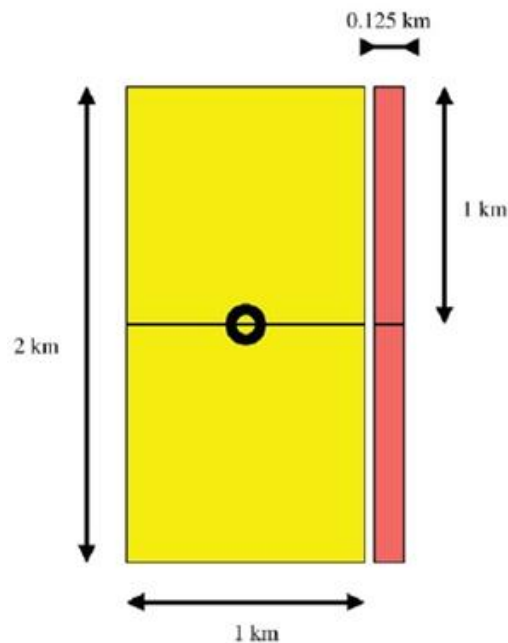

Figure 4-10: SLSTR Detector Configuration - 1 km Spatial Resolution Channels S7 - S9, F1 and F2 (MIR to TIR)

4.6.2 Radiometric Resolution

The nine bands in VNIR/SWIR/TIR

The radiometric bands of SLSTR are presented in the table below:

Band	λ centre (μm)	Width (μm)	Function	Comments		Res. (m)
S1	0.555	0.02	Cloud screening, vegetation monitoring, aerosol	Visible Near IR	Solar reflectance bands	500
S2	0.659	0.02	NDVI, vegetation monitoring, aerosol			
S3	0.865	0.02	NDVI, cloud flagging, Pixel co-registration			
S4	1.375	0.015	Cirrus detection over land	Short-Wave IR		
S5	1.61	0.06	Cloud clearing, ice, snow, vegetation monitoring			
S6	2.25	0.05	Vegetation state and cloud clearing			
S7	3.74	0.38	SST, LST, Active fire	Thermal infra-red Ambient bands (200 K - 320 K)		1000
S8	10.85	0.9	SST, LST, Active fire			
S9	12	1	SST, LST			
F1	3.74	0.38	Active fire	Thermal infra-red fire emission bands		
F2	10.85	0.9	Active fire			

Table 4-2: The radiometric bands of SLSTR, F1 and F2 fire bands are based on the same detectors as S7 and S8 but with an increased dynamic range to prevent saturation over fires.

4.7 Coverage

The SLSTR uses two independent scan chains each including a separate scan mirror. While more complex than the single scan system employed by the ATSR instrument, this configuration especially increases instrument swath coverage.

- Oblique view swath: ~ 740 km
- Nadir view swath: ~ 1 400 km.

The nadir swath is asymmetrical with respect to the nadir point to provide identical and contemporaneous coverage with [OLCI](#) ocean/land colour measurements.

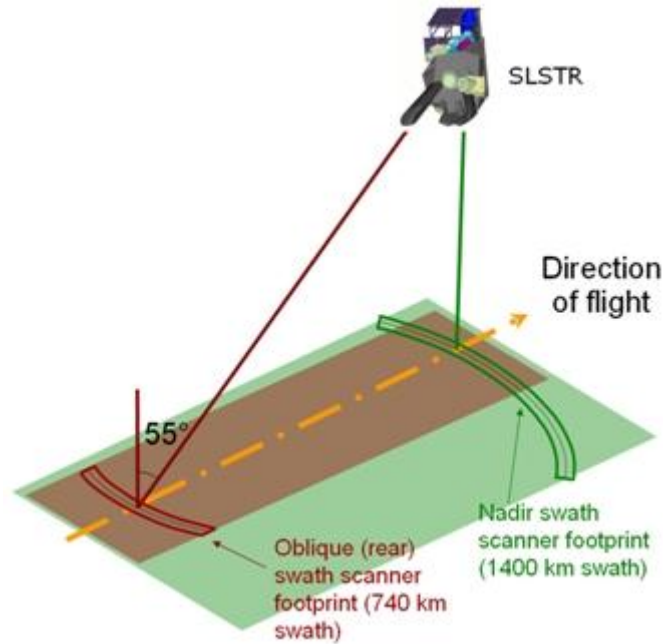

Figure 4-11: Outline sketch of the SENTINEL-3 SLSTR instrument viewing geometry highlighting the asymmetric nadir swath with respect to the nadir point

Following a trade-off analysis between topography and optical mission requirements, the choice of orbit for SENTINEL-3 is a sun-synchronous orbit at 814.5 km altitude (14 + 7/27 revolutions per day) with a local equatorial crossing time of 10:00 am. This satellite orbit provides a 27-day repeat.

The mean global coverage revisit time for dual view SLSTR observations is 1.9 days at the equator (one operational spacecraft) or 0.9 days (in constellation with a 180° in-plane separation between the two spacecraft) with these values increasing at higher latitudes due to orbital convergence.

	Constellation configuration	Revisit at equator	Revisit for latitude > 30°	Specification
SLSTR dual view (day and night)	One satellite	< 1.8 days	< 1.5 days	< 4 days
	Two satellites	< 0.9 days	< 0.8 days	

Table 4-3: Global coverage revisit times for SLSTR optical measurements

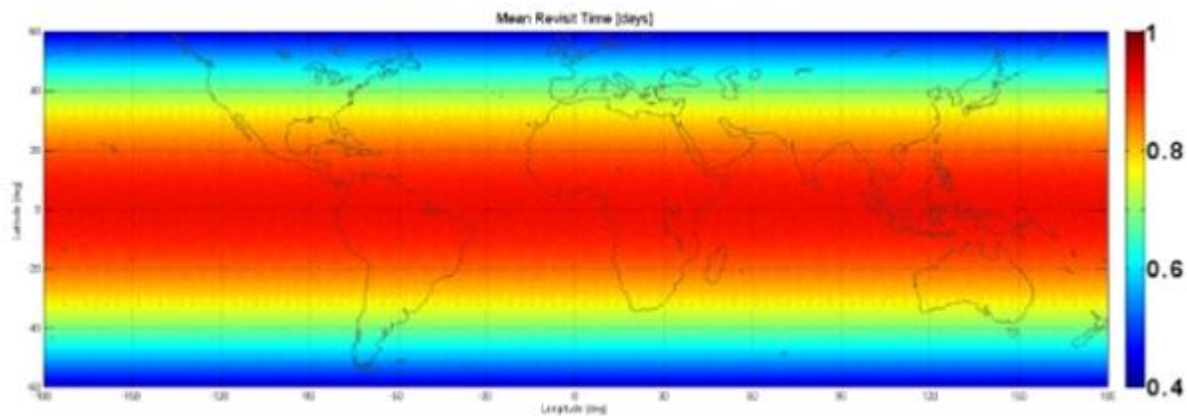

Figure 4-12: SLSTR Mean Revisit Time with Two-Satellite Configuration

4.8 Naming Convention

The file naming convention of SLSTR products ([see this document for more details](#)) is identified by the sequence of fields described below:

MMM_SL_L_TTTTTT_yyyymmddThhmmss_YYYYMMDDTHHMMSS_YYYYMMDDTHHMMSS_[instance ID]_GGG_[class ID].SEN3

where:

- **MMM** is the mission ID:
 - S3A = SENTINEL-3A
 - S3B = SENTINEL-3B
 - S3_ = for both SENTINEL-3A and 3B
- **SL** is the data source/consumer (SL = SLSTR)
- **L** is the processing level
 - "0" for Level-0
 - "1" for Level-1
 - "2" for Level-2
 - underscore "_" if processing level is not applicable
- **TTTTTT** is the data Type ID
 - Level 0 SLSTR data:
 - "SLT____" = ISPs.
 - Level-1 SLSTR data:
 - "RBT____" = TOA Radiances and Brightness Temperature
 - "RBT_BW" = browse product derived from "RBT____".

- Level-2 SLSTR data:
 - "WCT____" = 2 and 3 channels SST for nadir and along track view
 - "WST____" = L2P sea surface temperature
 - "LST____" = land surface temp
 - "WST_BW" = browse product derived from "WST____"
 - "LST_BW" = browse product derived from "LST____".
- **yyyymmddThhmmss** is the sensing start time
- **YYYYMMDDTHHMMSS** is the sensing stop time
- YYYYMMDDTHHMMSS is the product creation date
- **[instance ID]** The field consists of 17 characters, either uppercase letters or digits or underscores "_".
The instance id fields include the following cases, applicable as indicated:
 1. Instance ID for the instrument data products disseminated in "stripes":

Duration, "_", cycle number, "_", relative orbit number, "_", 4 underscores "_"
DDDD_CCC_LLL_____
 2. Instance ID for the instrument data products disseminated in "frames":

Duration, "_", cycle number, "_", relative orbit number, "_", frame along track coordinate
DDDD_CCC_LLL_FFFF
 3. Instance ID for the instrument data products disseminated in "tiles".
Two sub-cases are applicable:
 - a) tile covering the whole globe:
"GLOBAL_____"
 - b) tile cut according to specific geographical criteria:
Tile Identifier
tttttttttttttttt
 4. Instance ID for auxiliary data:
17 underscores "_"
- **GGG** identifies the centre which generated the file
- **[class ID]** identifies the class ID for instrument data products with conventional sequence **P_XX_NNN** where:
 - P indicates the platform (O for operational, F for reference, D for development, R for reprocessing)
 - XX indicates the timeliness of the processing workflow (NR for NRT, ST for STC, NT for NTC)
 - NNN indicates the baseline collection or data usage.
- **.SEN3** is the filename extension

Example of filename:

S3A_SL_2_LST_____20151229T095534_20151229T114422_20160102T150019_6528_064_365_____LN2_D_NT_001.SEN3

4.9 Data Formats and Sizes

4.9.1 Introduction

The SLSTR data format follows the format defined for each SENTINEL-3 product, i.e. the PDGS product specification, and is based on SENTINEL-SAFE. Each product package includes:

- a manifest file containing a metadata section and a data object section
- measurement data files
- annotation data files (except for *SL_2_WST_*)
- representation data files (XML files describing the binary information)(Level-0 only).

User product, generated for operational dissemination to SENTINEL-3 users, has to be distinguished from the internal product, which is only used internally for normal processing.

Following the three main processes, there are three main data packages: Level-0, Level-1 and Level-2.

Name of Product Package	Main Content	Availability	Latency	Estimated Size per orbit	Product Dissemination Unit
SL_0_SLT__	Full resolution ISPs	INTERNAL	NRT	7.2 GB	N/A
SL_1_RBT__	Brightness temperatures and radiances	USER	NRT/NTC	44.5 GB	Frame
SL_2_WCT__	Sea surface temperature (single and dual view, 2 and 3 channels)	INTERNAL	NRT/NTC	4.1 GB	N/A
SL_2_WST__	Level-2P sea surface temperature (GHRSSST-like)	USER	NRT/NTC	2.2 GB	Stripe
SL_2_LST__	Land surface temperature parameters and fire radiative power	USER	NRT/NTC	1.4 GB	Stripe

Table 4-4: Description and content of the different SLSTR product packages, , the estimated size corresponds to a full orbit without consideration about compression, NRT/NTC less than 3/48 hours after measurement by satellite.

4.9.2 Level-1

The SLSTR Level-1 product package is composed of one information package map, also called a manifest, and several measurement and annotation data files (between 77 and 111 files depending on the processing parameters).

For measurement files, *SL_1_RBT*, the Level-1B product includes between 22 and 34 radiance and brightness temperature measurements datasets. For nadir and oblique views, there is:

- one dataset for each channel S1 to S3, corresponding to A stripe
- up to three datasets for each SWIR channel S4 to S6, corresponding to A, B or TDI stripe
- one dataset for each thermal infra-red channel S7 to S9
- one dataset for each fire channel F1 and F2.

They contain, for each pixel on the full resolution grid and for each un-regridded pixel (also called orphan pixels), the radiance or brightness temperature and their associated exception flags. These files are all written in netCDF 4 format and include dimensions, variables and associated attributes.

Annotation data files are also written in netCDF 4 format. Their number and dimensions are described in the following table:

File Name	Dimensions	
Infrared Quality	Full resolution line; detectors and integrators	One for each view, for each channel and for each selected stripe
Global Flags Data file	Full resolution pixel grid and orphan pixels	One for each view and for each selected grid
Scan, pixel and detector number	Full resolution pixel grid and orphan pixels	One for each view and for each selected grid
FR Cartesian Coordinates	Full resolution pixel grid and orphan pixels	One for each view and for each selected grid
Tie points Cartesian Coordinates	Tie-point grid (1 km along-track and 16 km across-track)	One file
FR Geodetic Coordinates	Full resolution pixel grid and orphan pixels	One for each view and for each selected grid
Tie points Geodetic Coordinates	Tie-point grid (1 km along-track and 16 km across-track)	One file
Time	Full resolution line	One for each selected grid
Tie points Solar and Satellite Geometry	Tie-point grid (1 km along-track and 16 km across-track)	One for each view
Meteorological Parameters	Tie-point grid and specific meteorological dimensions	One file

Table 4-5: Description of the annotation data files included in the SLSTR Level-1 product

Associated with these files, an information package map describes, for each Level-1 file, the content unit identifier and description, and the type of data contained in each file.

A manifest file in XML format gathers together metadata associated with the instrument and the processing.

4.9.3 Level-2

The SLSTR Level-2 product is composed of three different packets, depending on processing parameters. A switch, defined for each Level-2 processing step, indicates if the associated product has to be generated.

- *SL_2_WCT*, the sea surface temperature for single and dual view, for 2 or 3 channels (internal product only)
- *SL_2_WST*, provided to the user, the Level-2P sea surface temperature
- *SL_2_LST*, provided to the user, the land surface temperature parameters.

As for the SLSTR Level-1 product, these three packages are composed of one information package map, also called the manifest, and several measurement and annotation data files (between 2 and 21 files depending on the package).

The manifest file is in XML format and gathers general information concerning product and processing.

The measurement and annotation data files are in netCDF 4 format, and include dimensions, variables and associated attributes. The included parameters are provided only on the 1 km grid, indexed by their along and across track indices. For measurement files:

- five sea surface temperature datasets, with their associated uncertainties and exception flags, are included in the *SL_2_WCT* packet
- only one measurement file, giving the latitude, longitude, time and sea surface temperature value is included in the *SL_2_WST* packet
- *SL_2_LST* includes two measurement files providing the land surface temperature, its uncertainty and some vegetation parameters.

Annotation files are generated from the annotation files included in the *SL_1RBT* package and their format is identical to the files in the Level-1 packet.

- The *SL_2_WST* packet contains no annotation files.
- The *SL_2_WCT* packet contains 15 annotation files providing flags, corresponding indices on the instrument grid and geodetic and cartesian coordinates.
- The annotation files associated with *SL_2_LST* provide the same parameters as in *SL_2_WCT* but are limited to 10 files.

Note that *SL_2_WCT* is an internal packet and is only used internally for normal processing reasons. It is not made available to users.

4.10 Definitions

4.10.1 Units

The table below summarises units and notations depending on the quantities used by the SLSTR products:

Quantity	Unit	Notation	Description
Irradiance	$10^{-3} \text{ W.m}^{-2}.\mu\text{m}^{-1}$	IU	spectral irradiance unit
Radiance	$10^{-3} \text{ W.m}^{-2}.\text{sr}^{-1}.\mu\text{m}^{-1}$	LU	spectral radiance unit
Time	jd or MJD	jd or MJD	modified Julian date 2000
	10^{-6}s	(1.e-6)s	microsecond
Distance	10^{-9}m	Nm	nanometre (wavelength)
	10^{-6}m	μm	micrometre (wavelength)
	m	m	metre
	10^3m	km	kilometre
Percentage	%	%	percentage
Temperature	K	K	degree Kelvin
	C	C	degree Celsius
Angle	°	deg	degree
	rad	rad	radian
Solid Angle	sr	sr	steradian
Pressure	hPa	hPa	hectoPascal
Ozone	kg.m^{-2}	kg.m^{-2}	kilogram per square metre
Dimensionless quantities	nc	nc	numerical counts
	dl	dl	dimensionless

Multiple dimension quantities	md	md	table constituted with different physical parameters having different units
-------------------------------	----	----	---

Table 4-6: SLSTR Units and notations.

4.10.2 Product Grid

Two grids can be defined for SLSTR outputs: the measurement grids, also called instrument reference frame, and the image grids. In addition, each grid contains a number of variations according to the different instrument view and resolution. Note however that, to be compliant with the continuity requirement, all SLSTR L1b and L2 files are defined on image grid. The Lo product is still associated with the instrument grid.

SLSTR products are generated separately in two instrument views:

- nadir view is almost vertical at the sub-satellite point
- oblique view has a local zenith angle close to 55°.

Two resolutions are then defined:

- a 500 m resolution for Visible/NIR/SWIR channels (S1 to S6)
- a 1 km resolution for thermal and fire channels (S7 to S9, F1 to F2).

The measurement grids are the native grids on which the SLSTR collects data. Each datum is indexed by scan, pixel and detector numbers. The scan number identifies the number of the scan line, starting at the ANX. The pixel number identifies, in a scan line, the pixel count, starting at one end. The detector number maps, for each pixel, the rows and the columns (aligned with the along track and across track directions) onto a two-dimensional matrix of detectors.

The image grids are locally cartesian and are regular grids aligned with the sub-satellite track. All measurement data are provided on this grid to hold an "image-like" data and to be compliant with the continuity requirement (i.e. SLSTR granules should be continuous)

In addition to these two grids, a lower resolution grid is defined and called the tie-point grid. Some annotations such as meteorological or viewing geometry data are produced on this grid. It is aligned with the 1 km and 0.5 km image grids and is regular in distance across track (16 km) and regular in time along track (1 km to fulfil the continuity requirement).

4.10.3 Notations

Accuracy: the difference between a result obtained and the 'true' value.

Along track: a path along the Earth's surface (corresponding to a satellite's direction of movement).

Channel: Spectral channel (S1-S9 + F1-F2).

Detector: Pixel array at band N.

Calibration: the process of quantitatively defining the system response to known, controlled system inputs.

Field-Of-View: the angular extent of a given scene that is viewed by the instrument.

Infra-red (IR) radiation: electromagnetic radiation of wavelengths between approximately 750 nm and 1 mm. This is broken down into five wavelength regions:

- **Near-IR** - 0.75-1.4 μm
- **Short-Wave IR** - 1.4-3 μm
- **Medium-Wave IR** - 3-8 μm
- **Long-Wave IR** - 8-15 μm.

Image swath: Maximum distance on ground between the positions of two spatial samples belonging to the same row.

Image sample: image element containing radiance measurements of co-registered pixels for all bands.

Pixel: the FOV of a single detector element; the projection of that detector element onto the ground at a given instant.

Precision: the difference between one result and the mean of several results obtained by the same method, i.e. reproducibility (includes random errors only).

Visible light: electromagnetic radiation detectable by the human eye with a wavelength between approximately 400 nm and 700 nm.

Scan: defined as a complete rotation of the scan mirrors.

Scan cycle: comprises two consecutive scans during which a complete set of targets are sampled.

Scan trace, or scan locus: the trace of a single detector element on the ground. For example, in the thermal channels each detector has two elements, and so a single scan gives two scan traces, displaced by 1 km in the along track direction at the swath centre in the nadir. Adjacent scan traces represent adjacent 'rows' of the instrument grid.

Target: either the Earth view or one of the internal calibration targets (the VISCAL and the two black bodies); in the context of the telemetry data it refers to a section of the scan during which valid data is obtained, when the detectors are viewing the earth view or one of the calibration targets.

4.11 Document Library

- [Sentinel-3 Optical User Test Data Set description](#)

This Technical Note is aimed at describing the Sentinel-3 Optical Test Data Sets (TDS) provided to the user community and the limitations of the TDS'. No detail on the tools used for the generation of the TDS will be provided, but only a high level description.

- [Sentinel-3 User Handbook](#)

The Sentinel-3 Mission Guide provides a high-level description of the mission objectives, satellite description and ground segment. It also covers an introduction to heritage missions, thematic areas and services, orbit characteristics and coverage, instrument payloads and data products.

- [GSC Sentinel-3 PDGS Products Definition](#)

This document is intended to provide the description of the Sentinel-3 products that will be generated within the Sentinel-3 Payload Data Ground Segment by the Sentinel-3 Instrument Processing Facilities (IPFs).

- [Sentinel-3 Product Data Format Specification - Product Structures](#)

This document aims to identify and specify the common definitions, structures and conventions of the Sentinel-3 products from Level 0 up to Level 2.

- [Sentinel-3 PDGS File Naming Convention](#)

This Technical Note provides the File Naming Convention adopted by the Sentinel-3 PDGS for the following data classes: Instrument data products, including

Level-0 products

Higher level data products

Auxiliary data

- [Sentinel-3 Product Data Format Specification - SLSTR Level 1 and 2 Instrument Products](#)

This document aims to identify and specify the format of the Sentinel-3 SLSTR products from Level 1 up to Level 2, browse products included.

NB: The product specifications reflect the current operation processor implementation - IPF V05 - they still could be updated before launch or during the commissioning phase.

- [Sentinels POD Service File Format Specifications](#)

The purpose of this document is to define the product structure and the content of each file generated and delivered by the POD Service Centre and the Sentinel-3 NRT POD Instrument Processing Facility (IPF) across its interfaces to the Sentinels (1, 2 and 3) Payload Data Ground Segments (PDGSs).

- [Sentinel-3 SLSTR Level-1 Observables ATBD](#)

This Algorithm Theoretical Basis document (ATBD) describes the algorithms used to produce the SLSTR Level-1 Radiometric Product and accompanying geo-location and environment data.

- [Sentinel-3 SLSTR Land Surface Temperature ATBD](#)

This document presents the Algorithm Theoretical Basis Document (ATBD) for the retrieval of Land Surface Temperature (LST) from thermal radiances measured by the Sea and Land Surface Temperature Radiometer (SLSTR).

- [Sentinel-3 SLSTR - Active Fire: Fire Detection and Fire Radiative Power ATBD](#)

This document describes the theory for the prototype multi-channel active fire detection and fire characterisation algorithm for use with data from the SLSTR sensor onboard the ESA Sentinel-3 satellite.

5 SENTINEL-3 SYNERGY USER GUIDE

5.1 Introduction

The SENTINEL-3 SYN User Guide provides a high level description of the SYN product which relies on the combination of the products of OLCI and SLSTR instruments. It also covers an introduction to relevant application areas, information on data distribution, product formatting and software tools available from ESA.

The categories are:

- **Overview**
Gives a brief overview of the [SYN heritage](#) in the continuity of the SPOT VEGETATION mission.
- **Applications**
Describes the support of the SENTINEL-3 SYN mission to [land monitoring and security](#) and [climate change monitoring](#).
- **Product Types**
Describes the granularity of SENTINEL-3 SYN products distributed to users: [Level-2 SYN](#) (surface reflectance and aerosol parameters over land), [Level-2 VGP](#) (TOA reflectances) and [Level-2 VG1 & V10](#) (VEGETATION-like products). The [Level-1C products](#) is not distributed to the users.
- **Processing Levels**
Illustrates the processing steps from [Level-1C](#) to [Level-2](#).
- **Resolutions** and **Coverage**
Defines the [spatial resolution](#), the [radiometric resolutions](#) and describes the coverage.
- **Naming Conventions** and **Data Formats & Sizes**
Describes the data naming conventions used and introduces the formatting used for [SYN Level-2 products](#).
- **Definitions**
Provides information on the [units](#), [notations](#) and [product grids](#) used in the acquisition and processing of SYN products.

For an in-depth description of the mission's products and algorithms as well as details on the SAR instrument and its performance, please refer to the [SENTINEL-3 SYN Technical Guide](#). The detailed information available in the Technical Guide is intended for users such as academics and industrial software engineers who have previous experience of similar EO missions, and in-depth experience of data manipulation and management.

5.2 Overview

[OLCI](#), in conjunction with the [SLSTR](#) instrument, provides the SYN products, providing continuity with SPOT VEGETATION.

The [primary objective](#) of [SYN products](#) is the monitoring of land use. SYN also provides information relating to worldwide food security and contributes to the study of climate.

5.2.1 Heritage

A requirement of the SENTINEL-3 mission is to provide surface vegetation products derived from synergistic and co-located measurements of [OLCI](#) and [SLSTR](#) optical instruments, similar to those obtained from the VEGETATION instrument on SPOT, and with complete Earth coverage in 1-2 days.

For 10 years, the SPOT VEGETATION mission has played an important role in meeting this need for information by offering high quality global data of the entire terrestrial surface on a daily basis to operational users.

The VEGETATION system relies on two observation instruments in orbit. The first of the two instruments (VEGETATION₁) is aboard the SPOT 4 satellite, launched on March 24th 1998. The second (VEGETATION₂) is aboard SPOT 5, which was placed into orbit on May 4th 2002. Having exceeded its planned life of 5 years it shall be replaced by the follow-on PROBA-V mission. PROBA-V has a ground resolution of 300 m and a swath width of 2 250 km. This small satellite also offers higher accuracy with respect to the instruments on the SPOT satellites. PROBA-V shall fill the gap between SPOT VEGETATION and the SENTINEL-3 satellite that will supply operational information on the state of the world's vegetation as well as numerous other products from 2013 onwards.

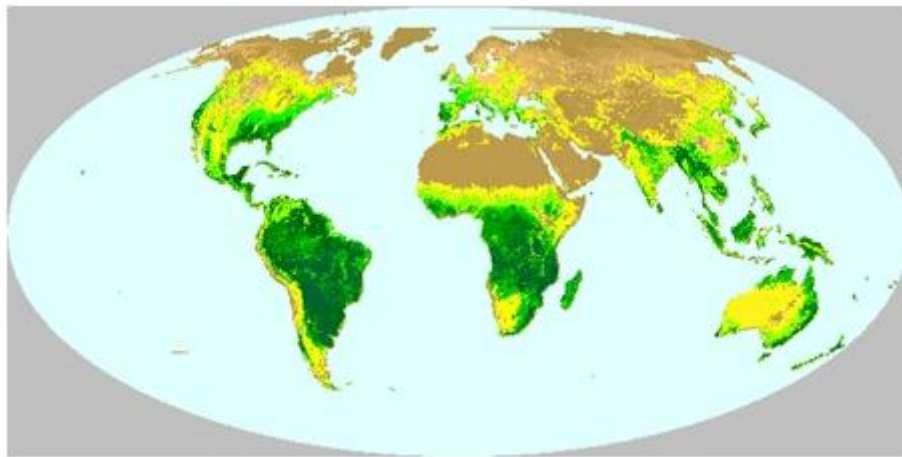

Figure 5-1: Vegetation Product (Credit: SPOT-VEGETATION project)

The series of SPOT VGT products to be replicated within the SYN branch of SENTINEL-3 processing (synergy of OLCI and SLSTR) consists of the physical (VGT P), daily synthesis (VGT S1) and 10 day synthesis (VGT S10)

The product names P, S1 and S10 correspond to the standard SPOT VGT product names.

The VGP products (corresponding to VGT-P SPOT products) are adapted for scientific applications requiring highly accurate physical measurements. The data is corrected for systematic errors (error registration of the different channels, calibration of all the detectors along the line-array detectors for each spectral band) and re-sampled to predefined geographic projections. The pixel brightness count is the ground area's apparent reflectance as seen at the top of atmosphere for all spectral bands.

The VG1 and V10 products (respectively VGT-S1 and VGT-S10 SPOT products) are a maximum NDVI value composite of ground reflectance measurements of all segments received during 1 day and 10 days, respectively, for the entire surface of the Earth. These products provide surface reflectance for all spectral bands, the NDVI and ancillary data on image acquisition parameters.

Note that the composite method of VGT-S product will be evaluated and updated in the frame of coming evolutions. It is not specified yet but the "max NDVI" composite method could be replaced by a different one, following the resulting recommendations.

5.3 Applications

Based on the combination of SLSTR and OLCI products, SYN is composed of mainly two Level-2 product types:

- Surface reflectances and aerosol parameters over land projected on OLCI 300 meters grid for all SLSTR and OLCI channels (except thermal and absorption)
- SPOT continuity products reproducing similar characteristics of the VEGETATION instrument observation. Ensuring the continuity of SPOT VEGETATION missions, its main aim is monitoring [land use](#), its evolution and impact of weather and climate on agricultural activities. SYN is also an essential information source for worldwide [food security](#). It would also be able to add to [climate](#) studies by supplying a continuous NDVI time series initiated by AVHRR and VEGETATION.

The following sections outline SYN’s applications. For further information about applications and services available, see: [Copernicus website](#).

5.3.1 Land Monitoring and Security

SYN product is similar to the SPOT VEGETATION (reflectance TOA and NDVI products). This enables the correct continuity of the NDVI series, introduced by the SPOT VEGETATION tandem. The SPOT VEGETATION system supports the monitoring of food security ^[21] and crops ^[22] through the provision of operational observations of vegetation at a spatial resolution of 1 km and at continental scales.

In the context of crop monitoring and food security, the most useful parameter delivered by SENTINEL-3 is the NDVI product. As with VEGETATION, this parameter is used for the early detection of deterioration of vegetation conditions and, as a consequence, of potential risk of drought. The evolution of a drought in the horn of Africa is shown in the image below, drawing attention to drought and subsequent famine ^[23].

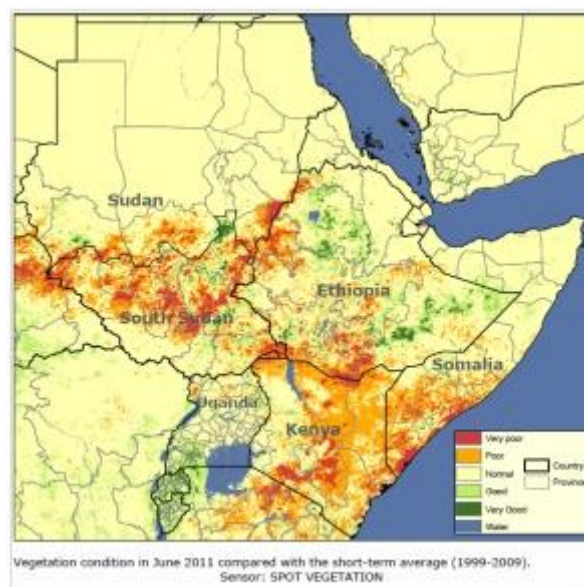

²¹ [Food Security from Space](#)

²² [Monthly Global Crop production for USDA](#)

²³ [Food Security Bulletin, JRC](#)

Figure 5-2: Vegetation Condition Index with SPOT VEGETATION (Credit: JRC)

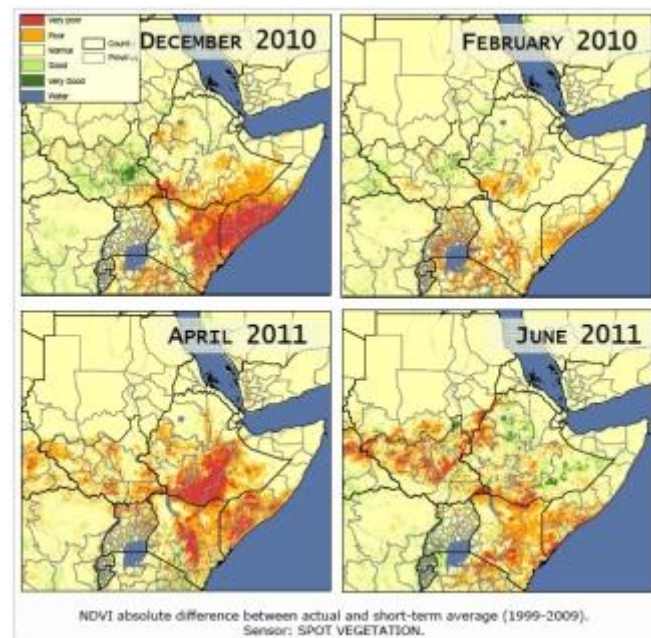

Figure 5-3: Vegetation Condition Through NDVI Evolution with SPOT VEGETATION (Credit: JRC)

Food security monitoring activities are supported by three European projects (Copernicus framework). They combine satellite data with agricultural models for:

- early warning
- agricultural mapping
- crop yield assessment service.

Since 1988, The European Monitoring Agricultural Resources (MARS) used satellite data at national, regional and continental scales to provide scientific and technical support on EU agricultural and food security policies.

SENTINEL-1, -2, and -3 are supplying Earth observation data for food security monitoring. These data are characterised by a high revisit time, large geographical coverage, rapid data dissemination and coherent and reliable information.

The capabilities of food security monitoring and forecasting will be based on the operational Copernicus Land Monitoring Service.

Even if Earth observation is increasingly used to examine crops globally, additional research and resources are required for:

- increasing the quality of satellite derived agricultural products
- reinforcement of field data collection for validation of satellite derived products
- maintenance of continuity and quality of current space-based food security monitoring systems
- precise definition of the requirements for future satellite data for agricultural monitoring
- integration of Earth observation data into traditional crop monitoring systems.

For further information about climate applications and services available, see: [Copernicus website](#).

5.3.2 Climate Change Monitoring

The need to support the work of the United Framework Convention on Climate Change (UNFCCC) and the Intergovernmental Panel on Climate Change (IPCC) led to the definition of the Essential Climate Variables (ECV). All ECVs are designed to be technically and economically feasible for systematic observation. For these variables, international exchange is needed for both present and historical observations. In early 2013, there were 50 ECVs.

The contribution of SYN products to ECV (terrestrial), land cover ^[24] is ensured by SYN S1 and SYN S10 products.

For further information about climate applications and services available, see: [Copernicus website](#).

5.4 Product Types

5.4.1 Introduction

The SYN product types are divided into six main products:

- one labelled as Level-1 product ([SY 1 MISR](#)) and outputted by the SYN Level-1 processing. The Level-1 product provides the correspondence grids between OLCI reference channel in the acquisition geometry and the others OLCI et SLSTR channels in their L1B image grids,. The Level-1 products are not disseminated to the users.
- Five labelled as Level-2 product and outputted by SYN Level-2 processing:
 - surface reflectances for all SYN channels and aerosol parameters over land ([SY 2 SYN](#))
 - surface reflectance associated with VGT channels and NDVI over land ([SY 2 VGK](#)) . These products are not disseminated to the users and defined to be the inputs of the VGT-S software.
 - Level-2 SPOT continuity products providing:
 - TOA reflectances ([SY 2 VGP](#))
 - maximim NDVI value composite received during 1 or 10 days (respectively called [SY 2 VGI](#) and [SY 2 V10](#))
 - Products labelled as _BW are the browse products

²⁴ [GCOS Essential Climate Variables \(ECV\) Data Access Matrix](#)

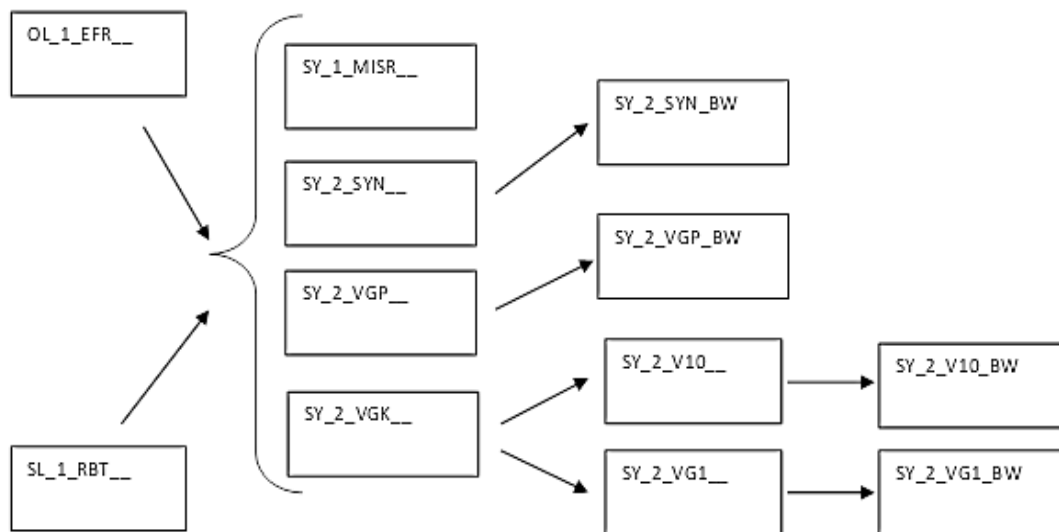

Figure 5-4: Synergy Product Tree

For further information about SYN product, see the **Technical Guide [Level-1 products](#) or [Level-2 products](#)**.

Note that, in the frame of coming evolutions, a specific Global aerosol product could be added. The content and the definition of this new product are not yet defined.

5.4.2 Level-1 SYN

The Level-1 SYN product (*SY_1_MISR*) is produced by the Synergy global software (level 1 + level 2 + VGT-P processing) and correspondence grids between all OLCI and SLSTR channels.

It is an internal product, not available to the user. According to the selected sub-bands for SLSTR SWIR channels, this product includes 26 to 36 files. All these files are misregistration files, considered as annotation files, containing the correspondence/collocation grids between OLCI/SLSTR L1b grids and SYN Level 2 reference grid:

- One misregistration dataset for each of the computed OLCI channels Oa1 – Oa21. The computation of absorption channels, unused in SYN Level 2 (Oa14, Oa15 and Oa20) can be disabled by a dedicated switch
- One misregistration dataset for each of the computed SLSTR channels S1 – S9, F1, F2, associated with nadir view. The computation of Thermal/Fire channels, unused in SYN Level 2 (S7 to S9, F1, F2) can be disabled by a dedicated switch
- One collocation dataset for each of the computed SLSTR grids associated with oblique view, The computation of stripe B and of the 1 km grid can be disabled by a dedicated switch

The misregistration / collocation values for rows and columns will be mapped onto a rectangular grid of 300 m resolution: the SYN Level 2 reference grid, similar to the OLCI acquisition grid associated with the OLCI reference channel.

5.4.3 Level-2 SYN

The Level-2 SYN product (*SY_2_SYN*) is produced by the Global Synergy Level-1/2 software and contains surface reflectance and aerosol parameters over land.

All measurement datasets are provided on the OLCI image grid, similar to the one included in OLCI L1b product, consisting of $N_COL_OLC \times N_LINE_OLC$ pixels with:

- $N_COL_OLC = 4865$ columns acquired
- $N_LINE_OLC = 60\ 000$ lines acquired for one orbit.

Some sub-sampled annotations and atmospheric datasets are provided on the OLCI tie-points grid. The measurement data files included in this product provide:

- Level-2 Surface Directional Reflectance (SDR) with their associated error estimates for the sun-reflective SLSTR channels (S1 to S6 for both nadir and oblique views) and for all OLCI channels, except for the oxygen absorption bands Oa14, Oa15, and the water vapour band Oa20
- Level-2 aerosol optical thickness at 550 m (referenced as T550) with error estimates
- Level-2 Angstrom coefficient (referenced as A550).

Several associated variables are also provided in annotation data files.

- Aerosol Model Index Number (AMIN). This value is an integer number in the table of 40 aerosol models used for the atmospheric correction. A zero value indicates missing data.
- Status flag computed by SYN Level-2 processing providing information about cloud, snow or land presence.
- Flags corresponding to OLCI quality and classifications flags and to SLSTR exception summary and confidence flags.
- DEM-corrected latitude, longitude and altitude.
- OLCI time stamps.
- Solar and viewing azimuth/zenith angles for each OLCI sub-sampled tie-point.
- Some geophysical atmospheric data (derived from ECMWF files) such as the mean sea level pressure, the total column ozone and water vapour.

Variables	Description	Units	Input Bands
SDR	Atmospherically corrected surface directional reflectance (also called Lambert equivalent reflectance (LER) or bidirectional reflectance factor (BRF)). Each dataset includes a single SYN channel	dimensionless	SLSTR S1 to S6 channels all OLCI channels except O14, 15 and O20
T550	Aerosol load, expressed in optical thickness at a wavelength of 550 nm.	dimensionless	SLSTR S1 to S6 channels all OLCI channels except O14, 15 and O20
A550	Estimated Angstrom exponent at a reference waveband of 550 nm.	dimensionless	SLSTR S1 to S6 channels all OLCI channels except O14, 15 and O20

Table 5-1: Description of Level-2 SYN product

5.4.4 Level-2 VGP

The Level-2 VGP SYN product (SY_2_VGP) is produced by the Global Synergy Level-1/2 software and contains 1 km VEGETATION-like product TOA reflectances.

The "1 km VEGETATION-like product" label means that measurements are provided on a regular latitude-longitude grid, with an equatorial sampling distance of approximately 1 km. This product is restricted in longitude, including only filled ones.

This product is referred to as SPOT Continuity Product, adapted for scientific applications requiring highly accurate physical measurements. As a consequence, data are corrected for systematic errors (such as error registration of the different channels or calibration of all the detectors along the line-array detectors for each spectral band) and resamples to predefined geographic projections.

The measurements files focus on four specific spectral bands.

- Bo channel, corresponding to blue spectral region with a central wavelength of 450 nm (computed using OLCI bands (Oa2 and Oa3)).
- B2 channel, corresponding to red spectral region and with a central wavelength of 645 nm (computed using OLCI bands (Oa6 to Oa10)).
- B3 channel, corresponding to NIR spectral region and with a central wavelength of 835 nm (computed using OLCI bands (Oa16 to Oa21)).
- MIR channel, corresponding to SWIR spectral region and with a central wavelength of 1 665 nm (computed using SLSTR bands (S5 and S6)).

Several additional pieces of information are contained in this product but provided on a sub-sampled grid (every 16th pixel).

- Status flags providing information about cloud, ice, snow or land presence and information about quality of spectral channel measurement.
- Geometric viewing conditions (view zenith and azimuth, sun zenith and azimuth).
- Aerosol optical thickness.
- Total column ozone.
- Total column water vapour.

5.4.5 Level-2 VGK

This product is similar to the SY_2_VGP product: same measurement and annotation files, same included parameters. The only difference is that the radiometric measurements have been corrected thanks to the aerosol model computed in SYN Level 2 processing. In addition this product is projected on the OLCI L1B image grid.

There are three additional files, one providing the NDVI and two annotation ones providing the time and the geolocation. It has been defined as an internal product, taken into account as the input of the dedicated VGT-S software.

5.4.6 Level-2 VG1 and V10

The Level-2 VG1 and V10 SYN products (*SY_2_VG1* and *SY_2_V10* respectively) are produced by the SYNERGY Level-2 processor and contain 1 km VEGETATION-like product ,1 and 10 days synthesis surface reflectances and NDVI. The product grid and the four spectral bands are similar to the SYN Level-2 VGP product. These products are provided by small software dedicated only to the combination and the production of VGT-S product. This software takes as input the VGK products

These products are a maximum Normalised Difference Vegetation Index (NDVI) value composite of ground reflectance measurements of all segments received during 1 or 10 days for the entire surface of the Earth. It can be ordered in a map projection specified by the user, covering the whole world or a region of interest defined by the user.

Note that in the frame of coming evolutions, the “max NDVI” composite method could be replaced by a different one.

SYN VG1 corresponds to the daily synthesis, i.e. the single "best" value for Top of Canopy (TOC, i.e. after an atmospheric correction) reflectance at the four selected channels, based on those giving the maximum value of a vegetation index.

SYN V10 product provides, for each spectral band (Bo, B2, B3, MIR) a decade synthesis of surface reflectance, defined at TOC. This synthesis is formed using the maximum value composite over the 10 day period.

In addition, the NDVI is provided. It is derived from the B3 and B2 channels and can be defined as an indicator of vegetation amount.

The parameters included in annotation files are similar to the ones included in the SYN Level-2 VGP package, with the exception of synthesis time. In this product, annotation data are provided for each pixel and not on a sub-sampled grid.

5.5 Processing Levels

5.5.1 Introduction

The SYN operational processor is divided into two major components:.

- Global SYN Level 1/2 software deals with OLCI and SLSTR Level-1B products and gathers [Level-1 processing](#) and [Level-2 processing](#).
 - [The Level 1 processing](#) computes OLCI and SLSTR radiometric measurements and associated annotation data in their acquisition geometry. The correspondence grids between OLCI reference pixels and all other OLCI and SLSTR pixels are also computed and all parameters are projected on the same OLCI reference acquisition grid.
 - The Level 2 and VGT-P processing deals with this set of parameters (OLCI/SLSTR measurement and annotation data) projected on the same grid to compute the Level-2 SYN product, Level-2 VGP product and Level-2 VGK products.
- A dedicated [VGT-S processing](#) deals with VGK product to compute daily and decade synthesis of surface reflectance, based on the maximum value of NDVI (this composite method will be evaluated and updated in the frame of coming evolutions). It produces VG1 and V10 products.

Note that, in future evolutions, a global aerosol over Ocean and Land pixels, will be included in SYN global processing in order to provide near real-time data suitable for assimilation within numerical weather prediction models, and with potential to provide timely warnings related to air quality and visibility. This modification will imply updates in Level 1 processing (to include Ocean pixels) and in Level 2 processing.

5.5.2 Level-1 processing

SYN Level-1 processing aims to retrieve OLCI and SLSTR radiances and brightness temperature in their acquisition geometry. The same computation is done for their associated annotations. This processing also aims to compute the correspondence grids between the OLCI reference channel and all other OLCI and SLSTR channels.

SYN Level-1 processing is divided into the following parts.

1. A pre-processing step which reads and adapts the Level-1B data for subsequent processing.
2. The main processing steps:
 - Inter-instrument mis-registration estimation aims to correspond, for each OLCI camera module, the reference SLSTR visible reference channel with the reference OLCI channel.
 - Computation of correspondence between the OLCI reference channel and all other OLCI and SLSTR channels, based on the mis-registration estimated at the previous step and on intra-instrument mis-registration estimation stored in a characterisation ADF.

- Projection of all OLCI/SLSTR and subsampled parameters on the same SYN reference grid (i.e. the OLCI acquisition grid)
- 3. Post-processing to define and write the Level-1 product, SY_1_MISR.

The pre-processing focuses on reading and adaptation of OLCI and SLSTR Level-1B product and is divided into two sub-steps.

1. An extended land/sea mask is applied to focus only on land surface
2. The OLCI retrieval section retrieves the full images of the five OLCI camera modules in their acquisition geometry. This processing involves radiometric measurement and associated annotations. The TOA radiance from OLCI reference channels is converted to TOA reflectance. A first selection ground control point (GCP) is also included. This Ground control point grid can be computed from an external database or regularly created.
3. A similar process except GCP selection is done for each channel of the SLSTR nadir and oblique views during SLSTR retrieval. The conversion is done for TOA radiance from SLSTR reference channels.

The main processing section is divided into four sections, gathering inter and intra-measurement spatial mis-registration.

4. The extraction of OLCI/SLSTR imagette pairs extracts imagettes around each GCP, one in the OLCI reference channel (called the context imagette) and one larger imagette in the SLSTR reference channel (called the search imagette). The search imagette is projected onto the OLCI geometry. This section also includes rejection tests on selected ground Control Points.
5. The sub-pixel shift estimation GCP sub-step computes a correlation surface between the two imagettes that is shifted around the GCP according to shift vectors and finds its sub-pixel maximum. This sub-step also includes final rejection tests on selected GCP. These two last sub-steps are performed for each selected GCP.
6. The deformation model estimation sub-step computes the parameters of a piece-wise deformation model giving the mis-registration of the reference SLSTR channel at each pixel of the OLCI selected channel.
7. The correspondence between reference OLCI and other channels sub-step uses all previously computed parameters and mis-registration ADFs to compute the correspondence between the OLCI reference channel image and all other OLCI channels, and SLSTR nadir channels. The correspondence between the OLCI reference channel and the SLSTR oblique channel is computed by estimating the common swath between these two images and establishing a superimposition in the gridded Level-1B product. These results are used to project all OLCI/SLSTR parameters on the same grid, the SYN reference grid, i.e. the OLCI acquisition one.

The post-processing step gathers all de-registration information, inter and intra-instrument and writes this information to the Level-1 product.

5.5.3 Level-2 and VGT-P processing

SYN Level-2 processing aims to combine information from the OLCI and SLSTR instruments to provide improved data for land surface analysis. It is divided into two main steps.

- The first step makes use of the enhanced spectral and angular capabilities of a combined instrument to propose a product with atmospherically corrected surface reflectance and corresponding information on aerosol properties.
- The second allows processing of data from SLSTR and OLCI to provide comparable products to SPOT-VGT to allow continuity of data delivery to the existing user community of SPOT-VGT.

SYN Level-2 processing aims to output the SY_2_SYN package. This processing can be formulated as one of multivariate optimisation subject to multiple constraints. Given a set of satellite TOA reflectances and an initial estimate of atmospheric profile, the corresponding set of surface reflectances is estimated. Application of the observed set to the estimated set of reflectances results in an error metric, where a lower value of the metric corresponds to a set of surface reflectances (and hence atmospheric profile) that is more realistic. These two steps are repeated with refined atmospheric profiles until convergence at an optimal solution. This entire process is divided into four main sub-steps:

1. Averaging of collocated TOA radiance over N pixels squared, to minimise the effect of errors in image collocation, whilst retrieving aerosol within the spatial scale of aerosol properties.
2. Pixel-wise retrieval of aerosol properties, itself divided into two main steps (atmospheric correction of averaged TOA radiance using an estimate of aerosol optical thickness and error metric calculation using spectral and bidirectional surface reflectance models).
3. Interpolation of aerosol properties retrieved for the averaged grid onto the collocated grid.
4. Atmospheric correction of collocated TOA radiance using the retrieved aerosol properties.

VGT Continuity processing aims to output the *SY_2_VGP*, and the *SY_2_VGK* products. It is divided into four sub-steps:

1. Band mapping to simulate the SPOT-VGT spectral bands (four bands) at top of atmosphere from the OLCI and SLSTR bands.
2. Pixel flagging, indicating land, water, cloud cover, ice/snow and cloud shadows. The cloud masking will be improved in the frame of coming evolutions. The best method (between idePix, Gomez-chova approach or combination between pseudo-bayesian and OLCI approaches, ..) will be investigated and implemented.
3. Projection from the ortho-geolocation grid to the SPOT VGT plate-carrée grid. At the end of this sub-step, the *SY_2_VGP* product can be written.
4. Atmospheric correction, similar to that used in SYN processing and computation of the NDVI. This last step aims to produce the VGK product.

A last step aims to define and write the SYN Level-2 products.

Note that, in the frame of coming evolutions, a specific global aerosol module will be added in the SYNERGY Level 2 processor. The level of inclusion is not yet specified (separate module or included in SYN Level 2). The main adaptations envisaged are known but details and equations are not yet defined:

- **Inversion procedure to retrieve continuous aerosol component mixture.**
- **Inclusion of prior climatology** of aerosol properties to constrain retrieval, especially SSA.
- **Uncertainty estimate** per retrieval.
- **Generation of new LUT** set to include 4 aerosol components (dust, sea salt, fine mode strong absorbing, fine mode weak absorbing), and all combinations of 25% mixtures of these, at wavebands/geometries for both SLSTR and OLCI.
- **Adaptation of CCI aerosol retrieval method** both for SLSTR channels and solar/view geometry, and for SLSTR/OLCI synergy. Over glint-free ocean an adaption of spectral estimation will be investigated to allow retrieval with SLSTR nadir view only.
- **Cloud masking.**
- **Inclusion of ocean model** giving surface reflectance and uncertainty, dependent on wind speed, ocean colour, for SLSTR & OLCI wavebands and view geometry.

5.5.4 VGT-S processing

The aim of VGT-S1 processing is to produce a daily or 10 days 1km SPOT-VEGETATION-like product (VGT-S1 or VGT-S10). This compositing is carried out on the VEGETATION Plate-Carrée projection grid with a resolution of 1 km at equator. The global VEGETATION grid is defined from 180W to 180E and from 56S to 75N with a regular latitude-longitude sampling grid with 112 pixels per degree.

The daily composite is produced from a set of *SY_2_VGK* track products. The longitude/latitude location of each VGK pixel is used to select the corresponding pixel in the output Plate-Carrée grid (equi-rectangular projection).

The pixels incorporated into the synthesis are selected according to the maximum NDVI value, in order to ensure coverage of all landmasses worldwide with a minimum effect of cloud cover. The surface reflectance and annotation of the

VGK pixel corresponding to the maximum NVDI is copied in the VGT-S1 product. The daily resulting product is called SY_2_VG1.

The VGT-S10 compositing processing is similar to the daily processing except that the inputs are daily products (SY_2_VG1) instead track products. It means the only difference is the way to get the geo-location pixel from the input pixels. The resulting product is called SY_2_V10.

Note that, in the frame of coming evolutions, the composite method used to create VGT-S1 and S10 products will be investigated and modified to ensure continuity to VGT and Proba-V service. Two options are under investigation:

1. Analyse the more adequate composite method between several known technics (the Best Index Slope Extraction or Mean Compositing methods, ...) and implement it in the VGT-S processing.
2. Update the NDVI computation and discuss the "max NDVI" composite method.

5.6 Resolutions

The SYN Level-1 product, also called Synergy product, results from the synergistic processing of OLCI Level-1B FR and SLSTR Level-1B products themselves derived from [OLCI](#) and [SLSTR](#) measurements (all channels).

5.6.1 Spatial Resolution

The SYN Level-1 radiometric measurements are derived from full resolution [OLCI](#) Level-1B (~300 m) and [SLSTR](#) Level-1B products (500 m for S1-S6 and 1 000 m for S7-S8 and F1-F2). The misregistrations or correspondence grids are provided on the SYN reference grid, i.e. the OLCI acquisition geometry:

- OLCI pixel resolution (PR ~300m) grid for each camera image, corresponding to each OLCI camera image $m = 1$ to 5 in its acquisition geometry

At Level-2, a resampling to any specific, user-defined grid is performed, taking into account the mis-registration and DEM-corrected geolocation information included in the SYN Level-1 product. All datasets are provided in full resolution (~300 m) on the L1B image grid of the OLCI reference channel. VGK are also provided on this grid.

VGT-P and VGT-S products are provided on a regular latitude-longitude grid, with an equatorial sampling distance of 1 km.

5.6.2 Radiometric Resolution

The SENTINEL-3 SYN Level-1 product contains all 43 channels of [OLCI](#) and [SLSTR](#) Level-1B TOA radiance and brightness temperature measurements (21 OLCI channels and 22 SLSTR channels, including near nadir, oblique view and fire channels) in their acquisition geometry.

SYN L2 Channel	SYN L1 Channel	Instrument Channel	λ centre (nm)	Width (nm)
1	B ₁	Oa ₁	400	15
2	B ₂	Oa ₂	412.5	10
3	B ₃	Oa ₃	442.5	10
4	B ₄	Oa ₄	490	10
5	B ₅	Oa ₅	510	10
6	B ₆	Oa ₆	560	10
7	B ₇	Oa ₇	620	10
8	B ₈	Oa ₈	665	10
9	B ₉	Oa ₉	673.75	7.5
10	B ₁₀	Oa ₁₀	681.25	7.5

11	B ₁₁	Oa ₁₁	708.75	10
12	B ₁₂	Oa ₁₂	753.75	7.5
13	B ₁₃	Oa ₁₃	761.25	2.5
	B ₁₄	Oa ₁₄	764.375	3.75
	B ₁₅	Oa ₁₅	767.5	2.5
14	B ₁₆	Oa ₁₆	778.75	15
15	B ₁₇	Oa ₁₇	865	20
16	B ₁₈	Oa ₁₈	885	10
17	B ₁₉	Oa ₁₉	900	10
	B ₂₀	Oa ₂₀	940	20
18	B ₂₁	Oa ₂₁	1 020	40
19	B ₂₂	S ₁	550	20
20	B ₂₃	S ₂	665	20
21	B ₂₄	S ₃	865	20
22	B ₂₅	S ₄	1 375	15
23	B ₂₆	S ₅	1 610	60
24	B ₂₇	S ₆	2 250	50
	B ₂₈	S ₇	3 740	380
	B ₂₉	S ₈	10 850	90
	B ₃₀	S ₉	12 000	1 000
	B ₃₁	F ₁		
	B ₃₂	F ₂		
25	B ₃₃	S ₁ ^{oblique}	550	20
26	B ₃₄	S ₂ ^{oblique}	665	20
27	B ₃₅	S ₃ ^{oblique}	865	20
28	B ₃₆	S ₄ ^{oblique}	1 375	15
29	B ₃₇	S ₅ ^{oblique}	1 610	60
30	B ₃₈	S ₆ ^{oblique}	2 250	50
	B ₃₉	S ₇ ^{oblique}	3 740	380
	B ₄₀	S ₈ ^{oblique}	10 850	90
	B ₄₁	S ₉ ^{oblique}	12 000	1 000
	B ₄₁	S ₉ ^{oblique}	12 000	1 000
	B ₄₂	F ₁ ^{oblique}		
	B ₄₃	F ₂ ^{oblique}		

Table 5-2: Input radiometric channels (green lines correspond to SYN L2 input channels)

The SYN Level-2 products are produced at OLCI full resolution, for the daylight part of the orbit over land, and only take as input TOA reflectance data for the six solar reflective SLSTR bands at both nadir and forward views (a total of 12 input channels), and the 18 OLCI bands at all non-absorbing channels (i.e. excluding OLCI oxygen bands 14, 15 and water vapour band 20). These channels are listed in the first column of the above table.

The VGT-P and VGT-S products include TOA and surface reflectances defined for VGT channels:

VGT channel	Central Wavelength (nm)	Bandwidth (nm)	Combined SYN Level 2 channels
B ₀	450	20	SYN channel 2 and channel 3
B ₂	645	35	SYN channels 6 to 10
B ₃	835	55	SYN channels 14 to 18
MIR	1665	85	SYN channel 23 and channel 24

Table 5-3: Definition of VGT channels

5.7 Coverage

Given that SYN products are computed from [OLCI](#) Level-1B and [SLSTR](#) Level-1B data (including nadir and oblique views), SYN swath coverage corresponds to the common part of the OLCI and SLSTR nadir view swaths for the daylight part of the SENTINEL-3 orbit, i.e. the entire OLCI swath: ~1 270 km (see figure below).

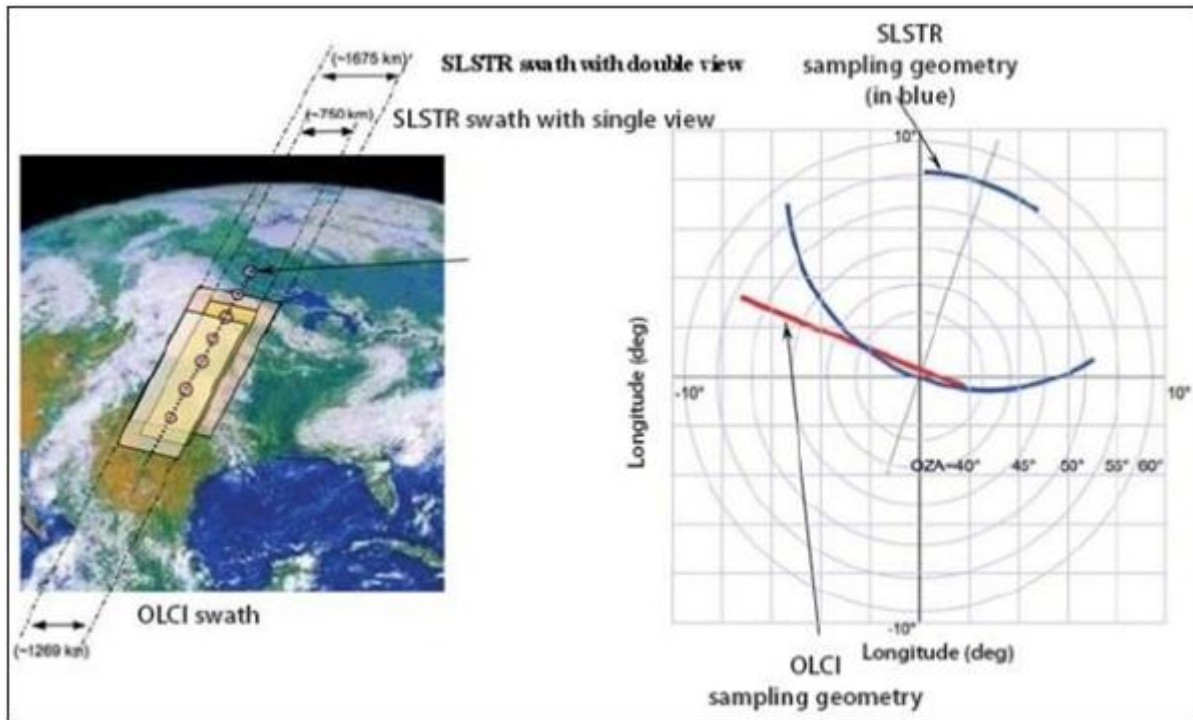

Figure 5-5: View of OLCI and SLSTR swath coverage and sampling geometry, in blue SLSTR oblique view (740 km) and nadir view (1400 km), in red OLCI (1270 km) (image credit: ESA)

As a result, the areas of the SLSTR nadir and oblique view Level-1B images not covered by the OLCI image, are rejected by cutting the images along track and across track. The daylight part of the orbit is defined for OLCI as the part of the orbit, where the sun zenith angle at satellite ground track is lower than 80° .

The VGP products cover latitude ranging from 56°S to 75°N (to be VEGETATION-like product).

The daylight part of the orbit is defined for OLCI as the part of the orbit where the sun zenith angle at satellite ground track is lower than 80° .

The mean global coverage revisit time is based on the longest revisit time of the two instruments, OLCI and SLSTR. It is less than 2 days at the equator with two operational satellites.

5.8 Naming Conventions

The file naming convention of SYN products ([see this document for more details](#)) is identified by the sequence of fields described below:

MMM_SY_L_TTTTTT_yyyymmddThhmmss_YYYYMMDDTHHMMSS_YYYYMMDDTHHMMSS_[instance ID]_GGG_[class ID].[extension]

where:

- **MMM** is the mission ID:
 - S3A = SENTINEL- 3A
 - S3B = SENTINEL-3B
 - S3_ = for both SENTINEL-3A and 3B.
- **SY** is the Data source/consumer (SY = Instrument Synergy)
- **L** is the processing level
 - "1" for Level-1
 - "2" for Level-2
 - underscore "_" if processing level is not applicable.
- **TTTTTT** is the Data Type ID
 - Level-1 Synergy data:
 - "MISR____" = Level-1 products
 - Level-2 Synergy data:
 - "SYN____" = land surface reflectance and aerosol parameters
 - "VGP____" = Vegetation P continuity product
 - "VG1____" = Vegetation S1 continuity product
 - "V10____" = Vegetation S10 continuity product
 - "SYN_BW" = browse product derived from "SYN____"
 - "VGP_BW" = browse product derived from "VGP____"
 - "VG1_BW" = browse product derived from "VG1____"
 - "V10_BW" = browse product derived from "V10____".
- **yyyyymmddThhmmss** is the sensing start time
- **YYYYMMDDTHHMMSS** is the sensing stop time
- **YYYYMMDDTHHMMSS** is the product creation date
- **[instance ID]** The field consists of 17 characters, either uppercase letters or digits or underscores "_".

The instance id fields include the following cases, applicable as indicated:

1. Instance ID for the instrument data products disseminated in "stripes":

Duration,"_", cycle number, "_", relative orbit number,"_", 4 underscores "_"

DDDD_CCC_LLL_____

2. Instance ID for the instrument data products

disseminated in "frames":

Duration, "_", cycle number, "_", relative orbit number, "_", frame along track coordinate

DDDD_CCC_LLL_FFFF

3. Instance ID for the instrument data products disseminated in "tiles".

Two sub-cases are applicable:

a) tile covering the whole globe:

"GLOBAL_____"

b) tile cut according to specific

geographical criteria:

Tile Identifier

ttttttttttttttt

4. Instance ID for auxiliary data:

17 underscores "_"

- **GGG** identifies the centre which generated the file
- **[class ID]** identifies the class ID for instrument data products with conventional sequence **P_XX_NNN** where:
 - P indicates the platform (O for operational, F for reference, D for development, R for reprocessing)
 - XX indicates the timeliness of the processing workflow (NR for NRT, ST for STC, NT for NTC)
 - NNN indicates the baseline collection or data usage.
- **.SEN3** is the filename extension.

Example of filename:

S3A_SY_2_VGP_____20040704T104000_20040704T104630_20150706T082312_0390_028_180_____LN2_D_NT_001.SEN3

5.9 Data Format and Sizes

5.9.1 Introduction

The SYN data format follows the format defined for each SENTINEL-3 product, i.e. the PDGS Product Specification. Each product package includes:

- a manifest file containing a metadata section and a data object section
- measurement data files
- annotation data files, if defined.

Level-2 user product, generated for the operational dissemination to SENTINEL-3 users, has to be distinguished from the internal Level-1 product, only used internally for normal processing reasons.

Name of Product Package	Main Content	Availability	Latency	Estimated size per orbit	Product Dissemination Unit
-------------------------	--------------	--------------	---------	--------------------------	----------------------------

SY_1_MISR	All OLCI and SLSTR Level-1B ungridded brightness temperatures and radiances	internal	NTC	24,80 GB	N/A
SY_2_SYN	Surface reflectance and aerosol parameters over land	User	NTC	42,94 GB	Stripe
SY_2_VGP	1 km VEGETATION-like product - TOA reflectance,	User	NTC	1.38 GB	Stripe
SY_2_VGK	VGT Surface reflectance and NDVI	internal	NTC	6.74 GB	Stripe
SY_2_VG1	1 km VEGETATION-like product - 1 day synthesis surface reflectance and NDVI	User	NTC	10,7 GB	Tiles
SY_2_V10	1 km VEGETATION-like product - 10 days synthesis surface reflectance and NDVI	User	NTC		Tiles

Table 5-4: Description and Content of the different SYN Product Package, the estimated size corresponds to a full orbit without consideration about compression, NTC should be less than 48 hours (to be confirmed) after measurement by satellite.

5.9.2 SYN Level-1 Format

The SYN Level-1 product is composed of one packet not provided to the user, the SY_1_MISR product. It is composed of one information package map, also called a manifest, and several annotation data files.

The manifest file is written in XML format and gathers general information concerning the product and processing. The annotation data files are written in netCDF 4 format, and include dimensions, variables and associated attributes.

The SY_1_MISR package includes 26 to 36 files. All these files are misregistration ones, containing the correspondence/collocation grids between OLCI/SLSTR L1b grids and SYN Level 2 reference grid:

- One misregistration dataset for each of the computed OLCI channels Oa1 – Oa21. The computation of absorption channels, unused in SYN Level 2 (Oa14, Oa15 and Oa20) can be disabled by a dedicated switch
- One misregistration dataset for each of the computed SLSTR channels S1 – S9, F1, F2, associated with nadir view. The computation of Thermal/Fire channels, unused in SYN Level 2 (S7 to S9, F1, F2) can be disabled by a dedicated switch
- One collocation dataset for each of the computed SLSTR grids associated with oblique view, The computation of stripe B and of the 1 km grid can be disabled by a dedicated switch

5.9.3 SYN Level-2 Format

The SYN Level-2 product is composed of five different packets, all available to the user except the VGK product:

- SY_2_SYN includes surface reflectances and aerosol parameters over land
- SY_2_VGP includes TOA reflectances on 1 km VEGETATION-like product
- SY_2_VGK includes surface reflectances and NDVI for spectral VGT channels
- SY_2_VG1 includes 1 day synthesis surface reflectance and NDVI on 1 km VEGETATION-like product
- SY_2_V10 includes 10 day synthesis surface reflectance and NDVI on 1 km VEGETATION-like product.

As for Sentinel 3 products, all these packages are composed of one information package map, also called a manifest, and several measurement and annotation data files.

The manifest file is written in XML format and gathers general information concerning the product and processing. The measurement and annotation data files are written in netCDF 4 format, and include dimensions, variables and associated attributes.

The *SY_2_SYN* package includes 33 measurement data files and nine annotations data files.

The first 30 measurement files provide Surface Directional Reflectances (SDR) and their associated error estimates for all OLCI channels (except Oa14, Oa15 and Oa20) and SLSTR solar channels, nadir and oblique view. As files are projected on the OLCI image grid, one specific file is dedicated to the removed pixels. The last two provide aerosol optical thickness at 550 nm and the aerosol Angstrom exponent, also projected on the image grid of OLCI reference channel.

The annotation files are the following:

- angles and geographical information for OLCI and SLSTR tie-points (on nadir and oblique view) provided on dedicated tie-point grids
- geolocation for the OLCI reference channel
- time of measurement for each line of the OLCI reference channel
- geophysical atmospheric data, derived from the OLCI meteorological annotation file
- global flags, computed during Level-1 processing but also during OLCI and SLSTR processing, provided on the OLCI image grid
- Synergy Aerosol Model Index Number data file (*SYN_AMIN*) provided on the OLCI reference image grid
- all annotation data associated with removed pixels.

The *SY_2_VGP*, *SY_2_VG1* and *SY_2_V10* packages are designed as SPOT continuity products. They include respectively four and five measurement data files in addition to eight and nine annotation data files.

The measurement data files included in *SY_2_VGP* provide VEGETATION TOA reflectance for each defined spectral band, i.e. B0 for 450 nm (central wavelength), B2 for 645 nm, B3 for 835 nm and MIR for 1 665 nm. The reflectances are indexed by number of columns, line by latitude and longitude dimension. Their geographical positions are also included in these files.

The annotation data files included in *SY_2_VGP* provide, for sub-sampled columns and lines, in addition to their geographical position, solar/ viewing azimuth and zenith angle (respectively referenced as *saa*, *sza*, *vaa*, *vza*), aerosol optical thickness at 550 nm (*ag*), total column ozone (*og*) and water vapour (*wvg*) and the status flags (*sm*).

The *SY_2_VG1* and *SY_2_V10* packages include similar files to the *SY_2_VGP* packages but *VG1* provides the single best value for TOA reflectance at the four specific channels over 1 day period and *V10* provides the maximum value composite over a 10 day period at the four channels.

In addition, the Normalised Difference Vegetation Index (NDVI) is provided in a measurement file and the synthesis time data (*tg*) is provided in an annotation data file.

The *SY_2_VGK* product is similar to the *SY_2_VGP* product but the included radiometric measurements are surface reflectance (i.e. aerosol corrected). In addition this product is projected on the OLCI L1B image grid and provides also NDVI, time and geolocation associated with each OLCI image pixel.

Note that, following coming evolutions, a specific Global aerosol product could be added. The content and the definition of this new product are not yet defined.

5.10 Definitions

5.10.1 Units

The table below summarises the geophysical units that are used in the SYN products.

	Descriptive Name	Variable ID	Units
--	------------------	-------------	-------

GLOBAL	S3 L1 TOA Radiance and Brightness Temperature		$\text{mW m}^{-2}\text{sr}^{-1}\text{nm}^{-1\text{M}}, \text{W m}^{-2}\text{sr}^{-1}\mu\text{m}^{-1}$
	DEM-corrected geolocation (longitude, latitude, altitude)		deg, deg, m
	Time stamps		μs
	Solar and satellite angles		deg
	Atmospheric and meteorological data		various
LAND	SYN Surface Directional Reflectance	SDR_ <i>i</i>	dimensionless
	SYN Aerosol Optical Thickness	T550	dimensionless
	SYN Aerosol Angstrom Exponent	A550	dimensionless
	SYN Aerosol Model Index Number	AMIN	dimensionless
	VGP TOA Reflectance	B0, B2, B3, MIR	dimensionless
	VGK Surface Directional Reflectance	B0, B2, B3, MIR	dimensionless
	VGK NDVI	NDVI	dimensionless
	S1 Surface Directional Reflectance	B0, B2, B3, MIR	dimensionless
	S10 Surface Directional Reflectance	B0, B2, B3, MIR	dimensionless
	S1 NDVI	NDVI	dimensionless
	S10 NDVI	NDVI	dimensionless

Table 5-5: Units of SYN products

Other general quantities have the units shown in the table below.

Quantity	Unit	Notation	Description
Irradiance	$10^{-3} \text{W.m}^{-2}.\mu\text{m}^{-1}$	IU	spectral irradiance unit
Radiance	$10^{-3} \text{W.m}^{-2}.\text{sr}^{-1}.\mu\text{m}^{-1}$	LU	spectral radiance unit
Time	jd or MJD	jd or MJD	modified Julian date 2000
	10^{-6}s	(1.e-6)s	microsecond
Distance	10^{-9}m	nm	nanometre (wavelength)
	10^{-6}m	μm	micrometre (wavelength)
	m	m	metre
	10^3m	km	kilometre
Percentage	%	%	percentage
Temperature	K	K	degree Kelvin
	C	C	degree Celsius
Angle	°	deg	degree
	rad	rad	radian
Solid Angle	sr	sr	steradian
Pressure	hPa	hPa	hectoPascal
Ozone	$\text{kg.m}^{-2\text{M}}$	$\text{kg.m}^{-2\text{M}}$	kilogram per square metre
Dimensionless quantities	nc	nc	numerical counts
	dl	dl	dimensionless
Multiple dimension quantities	md	md	table constituted with different physical parameters having different units

Table 5-6: Units and notations.

5.10.2 Product Grid

Three different SYN product grids have been defined.

The correspondence grids included in the Level-1 product are provided on the OLCI acquisition geometry; The OLCI pixel resolution grid for each camera image (going from one to five) in its acquisition geometry. Note that we focus on full resolution grid (300 m).

The product grid for Level-2 atmospheric correction datasets is the OLCI image grid associated with the reference channel and defined in the Level-1B product.

Note that an OLCI sub-sampled grid is defined according to the tie-points included in OLCI and SLSTR Level-1B product. VGK product is also projected on this rectangular and ortho-geolocated grid.

VGT continuity products are calculated for the same regular latitude-longitude sampling (equivalent to a plate-carrée projection) with a longitudinal sampling distance at the Equator of 1 km square. Pixel coordinates in this grid are illustrated in the figure below (green square).

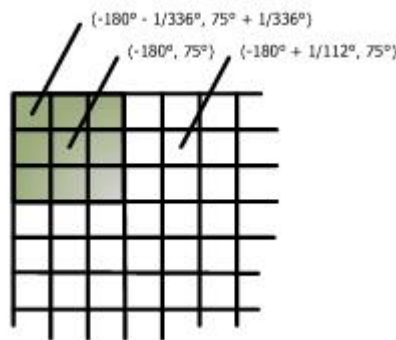

Figure 5-6: SPOT VGT 1 km Plate-Carrée Grid Cell

5.10.3 Notations

Collocation grid: this is a correspondence grid established using only the Level-1B orthorectified geolocation information.

SLSTR **along track** view is also called **oblique view**.

Solar channels: channels with central wavelength lower than 3.0 μm (SLSTR S1 to S6 and all OLCI channels).

Thermal channels: channels with central wavelength larger than 3.0 μm (SLSTR S7 to S9 and F1, F2).

Visible radiation: electromagnetic radiation detectable by the human eye with a wavelength between approximately 400 nm and 700 nm (OLCI Oa1 to Oa11 and SLSTR S1 and S2 channels).

Infra-red (IR) radiation: electromagnetic radiation of wavelengths between approximately 750 nm and 1 mm. This is broken down into five wavelength regions:

- **Near-IR** - 0.75-1.4 μm (OLCI Oa12 to Oa21, SLSTR S3 and S4 channels)
- **Short-Wave IR** - 1.4-3 μm (SLSTR S5 and S6 channels)
- **Medium-Wave IR** - 3-8 μm (SLSTR S7 and F1 channels)
- **Long-Wave IR** - 8-15 μm (SLSTR S8, S9 and F2 channels).

SWIR sub-bands: for any SLSTR SWIR channel (S4 to S6) the two-column detectors acquire simultaneously two images called the "A" and "B" sub-bands (or stripes). Furthermore the SLSTR Level-1B processing computes a third image from these two images which is called the "TDI" (or "averaged") sub-band. In this document the 1 km channels are sometimes referred to as 1 km sub-bands for simplification.

Ground Control point or **correlation point** or **GCP:** landmark, visible and located on two images, where local residual mis-registration between these images is estimated by a matching process.

Earth surface: the Earth surface is modelled as a Digital Elevation Model (DEM) (provided as CFI) on top of the WGS84 ellipsoid model.

(Direct) geolocation function: function that maps a point (k,j) (possibly non-integers) in an image to a point (x,y,z) on the ellipsoid surface. It is subtended by a model of the line of sight coming from point (k,j) .

Inverse geolocation function: the inverse function of the direct geolocation function.

(Direct) ortho-rectified geolocation function: function that maps a point (k,j) (possibly non-integers) in an image to a point (x,y) on the Earth surface, by taking into account a DEM $z = DEM(x,y)$. Theoretically (x,y,z) is the intersection of the line of sight coming from (k,j) with the Earth surface modelled as a DEM on top of a reference ellipsoid. The terrain point location is corrected from the relief effect, compared to the one computed with the direct geolocation function.

Inverse ortho-rectified geolocation function: the inverse function of the direct orthorectified geolocation function.

Restituted value: value retrieved when all known corrections have been applied.

(Mis-)knowledge error: residual error when all known corrections have been applied. The true value is given by adding the (unknown) (mis-)knowledge error to the restituted value.

Inter-channel spatial co-registration, simply referred to here as **co-registration** or **mis-registration**: The definition given in [AD03] is: maximum equivalent ground distance between the positions of all pairs of spatial samples acquired in two spectral channels and related to the same target on Earth.

Inter-instrument spatial mis-registration: mis-registration between one reference OLCI channel and one reference SLSTR channel.

Intra-instrument spatial mis-registration: mis-registration between all the channels within the same instrument.

Image sample/pixel: pixel stands for Picture Element. Each pixel is a measure of radiance generally gridded, with coordinates (k,j) in an image (k indexes the rows, j indexes the columns).

Instrument sample / instrument pixel / acquired pixel: (all equivalent terms). Pixels really acquired by an instrument, before any geometric transformation. An instrument sample may or may be not calibrated. When not calibrated, this is a synonym of a digital count.

Frame: the set of measurements acquired by the OLCI instrument at a given time

Coastal zone: sea surface extending from the coast up to 300 km offshore (from [AD-1])

Ancillary data: a classical definition is "all on-board data, other than observation and HKTM data, necessary for the products processing". This would include in particular not only various parameters and settings but also satellite data such as OBT and time correlations if needed, navigation data, etc.

Auxiliary data: We limit our understanding of auxiliary data to all complementary data provided to the Ground Segment (PDGS) by external providers in order to process the Level-1 and above products.

Product Data: Any data produced by the ground segment processing.

Search window: small window (grid) centred on a tie-point in OLCI geometry. It is a set of coordinates. It is used to extract a search imagette of SLSTR channel for correlation with the context window during the inter-instrument mis-registration estimation.

Context window: small window (grid) moved around the search window (along shift vectors) in OLCI channel geometry. It is a set of coordinates. It is used to extract a context imagette of OLCI channel for correlation with the search chip during the inter-instrument mis-registration estimation.

Context imagette: the radiometric counterpart of the context window, obtained by extracting the OLCI channel radiometry corresponding to the context window. If C is a context imagette $W(C)$ represents the corresponding context window

Search imagette: the radiometric counterpart of the search window, obtained by resampling the SLSTR channel radiometry to the search window. If S is a search imagette $W(S)$ represents the corresponding search window

Orbital Revolution Number: this number identifies the SENTINEL-3 orbit within the orbital cycle. There are 385 orbits per cycle, making the Orbital Revolution Number between 0 and 384.

Orphan pixels (for SLSTR) or removed pixels (for OLCI): These are pixels acquired by the instruments but not retained in the Level-1B gridded image, due to the Level-1B (nearest neighbour) projection on the product grid. For OLCI, those pixels mainly come from overlapping areas between adjacent camera modules. For SLSTR they may come from a possible oversampled acquisition at nadir of the nadir-view, with respect to the Level-1B image gridding. In oblique view there are many orphans due to scan-to-scan along track overlap. To answer the Level-1 requirements, all those pixels are retained in Level-1B products but not gridded.

Scan: a scan is defined as a complete rotation of the SLSTR scan mirrors.

Instrument scan or scan trace: It is the trace of a single SLSTR detector element on the ground. For example in the thermal channels, each detector has two elements, and so a single scan will give two scan traces, displaced by 1 km in the along track direction. Adjacent scan traces represent adjacent 'rows' of the instrument grid.

Image scan: a line of pixels in the SLST Level-1B product. Note that in the Level-1 product an image scan and an instrument scan should refer to the same thing.

Deformation model: in the Level-1 processing this term refers to the interpolation model applied on the (potentially) irregular grid of tie-points and representing the deformation field between OLCI and SLSTR in the OLCI geometry.

Correspondence grids: the main output of the Level-1 processing, stored in the mis-registration data files in the Level-1 product. These are grids that link any OLCI pixel in the reference band to the corresponding sub-pixel location in the other OLCI and SLSTR bands such that if a detector were placed at the sub-pixel location it would have seen the same target on Earth as the reference pixel.

5.11 Document Library

- [Sentinel-3 Optical User Test Data Set description](#)

This Technical Note is aimed at describing the Sentinel-3 Optical Test Data Sets (TDS) provided to the user community and the limitations of the TDS'. No detail on the tools used for the generation of the TDS will be provided, but only a high level description.

- [Sentinel-3 User Handbook](#)

The Sentinel-3 Mission Guide provides a high-level description of the mission objectives, satellite description and ground segment. It also covers an introduction to heritage missions, thematic areas and services, orbit characteristics and coverage, instrument payloads and data products.

- [GSC Sentinel-3 PDGS Products Definition](#)

This document is intended to provide the description of the Sentinel-3 products that will be generated within the Sentinel-3 Payload Data Ground Segment by the Sentinel-3 Instrument Processing Facilities (IPFs).

- [Sentinel-3 Product Data Format Specification - Product Structures](#)

This document aims to identify and specify the common definitions, structures and conventions of the Sentinel-3 products from Level 0 up to Level 2.

- [Sentinel-3 Product Data Format Specification - Synergy Level 1 and 2](#)

This document aims to identify and specify the format of the Sentinel-3 Synergy products, browse products included. NB: The product specifications reflect the current operation processor implementation - IPF V05 - they still could be updated before launch or during the commissioning phase.

- [Sentinels POD Service File Format Specifications](#)

The purpose of this document is to define the product structure and the content of each file generated and delivered by the POD Service Centre and the Sentinel-3 NRT POD Instrument Processing Facility (IPF) across its interfaces to the Sentinels (1, 2 and 3) Payload Data Ground Segments (PDGSs).

- [Sentinel-3 Synergy Level-2 and Level-3 ATBD](#)

This document describes the algorithms for synergistic processing of data from SLSTR and OLCI to (i) retrieve aerosol optical properties and surface reflectance for cloud-free atmospheres over land, and (ii) to provide comparable products to SPOT-VGT, to allow continuity of data delivery for existing user community of SPOT-VGT. The document includes all assumptions, discusses technical tradeoffs and describes the algorithms in terms of physical background as well as mathematical breakdown.