

DOWNLOADING ILWIS

Ilwis is freely available at :

<http://52north.org>

The latest version is 3.8.05 and can be downloaded by using the following link:

<http://52north.org/downloads/send/151-ilwis-3-08-05-package/470-n52-ilwis-v3-08-05>

INSTALLING ILWIS

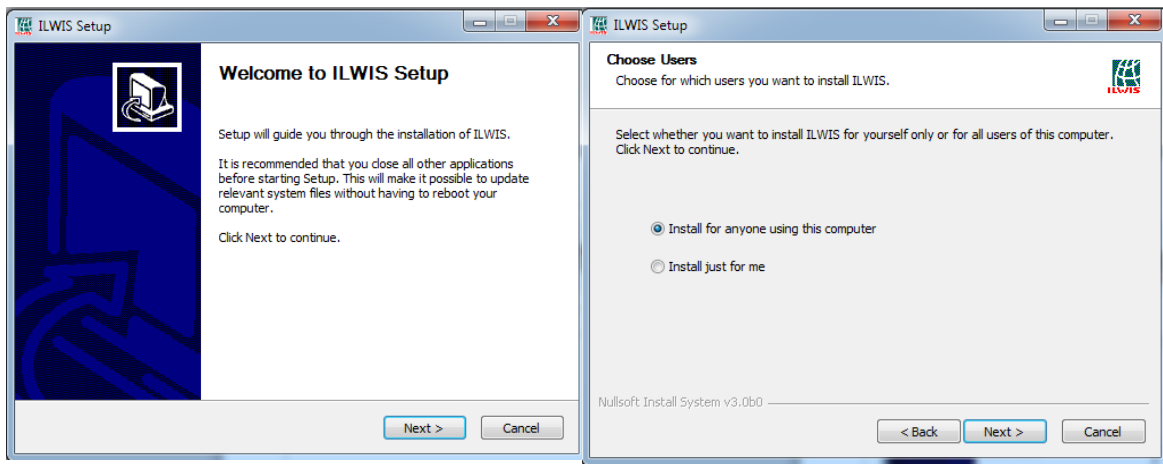

The first screen is a welcome screen. Press next

The second screen offers you the option that the program is available for all users or only for the current logged in user (you). The default all. Press next

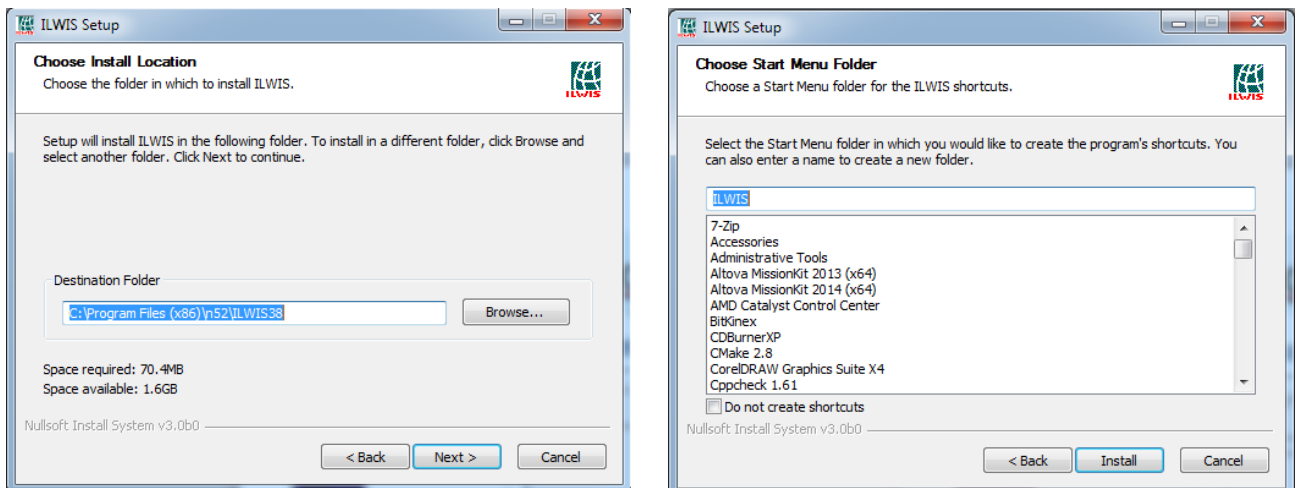

The third screen is the place on your hard disk where ilwis 3.8.5 is installed. If you accept the default press next, else use the browse button to navigate to an appropriate location and then press next

The last screen offers you options for how ilwis will be available in the start menu. If you accept the default press install

After this installation will start and press next and finish when it is done

RUNNING ILWIS

Ilwis can be found in the start menu under “all programs” at “ILWIS”. Click on the ilwis icon and ilwis will start.

You will see a screen similar to this:

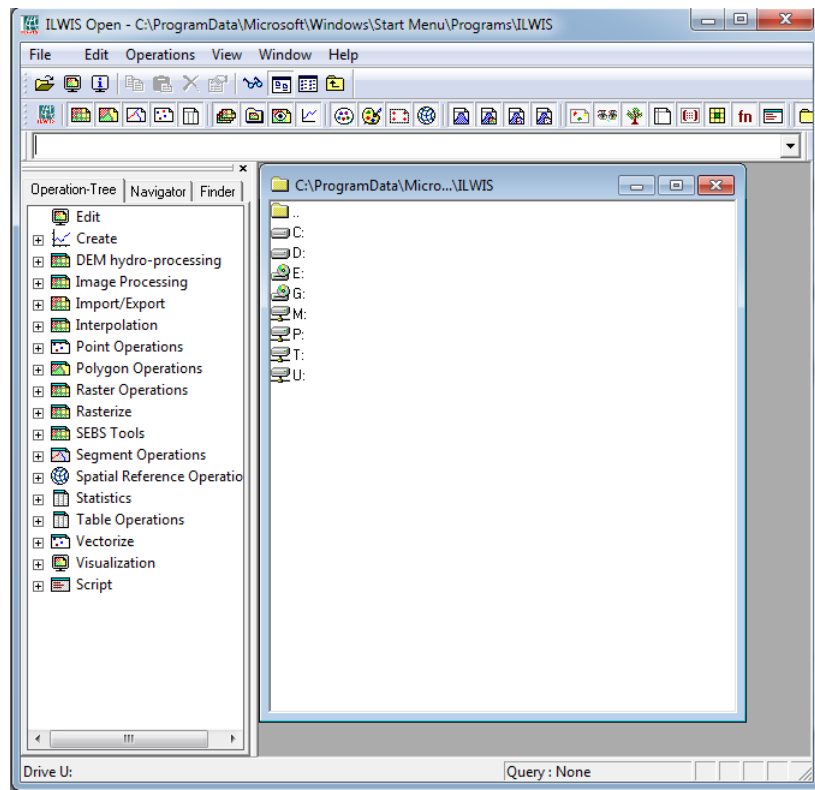

INSTALLING TUTORIAL DATA

EXPLORING THE MAINWINDOW

The mainwindow consist of several components

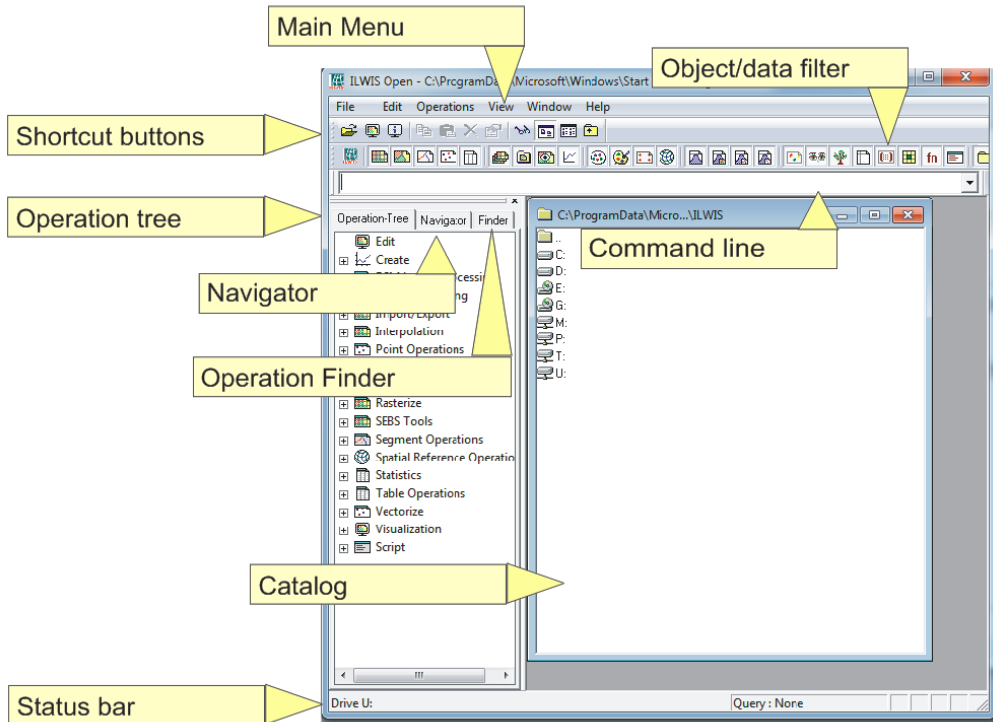

NAVIGATOR

Click on the tab navigator. This shows a folder navigator which you can use to navigate to your data.

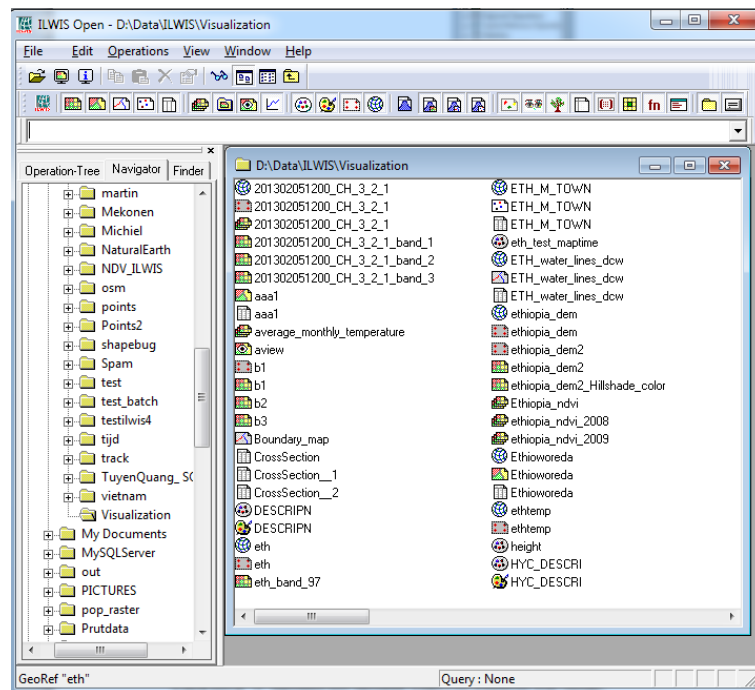

Click on a '+' symbol (or double click) to expand the node.

Selecting a folder or drive will show the content the current active catalog

Using the context menu (right mouse button) gives access to a small menu to create new catalogs or folders.

OPERATION TREE AND OPERATION FINDER

Ilwis has many operation available for spatial operations. They can be found under the operation tree and operation finder which are two views on the same set of operations.

In the tree all operations are divided in a number of categories.

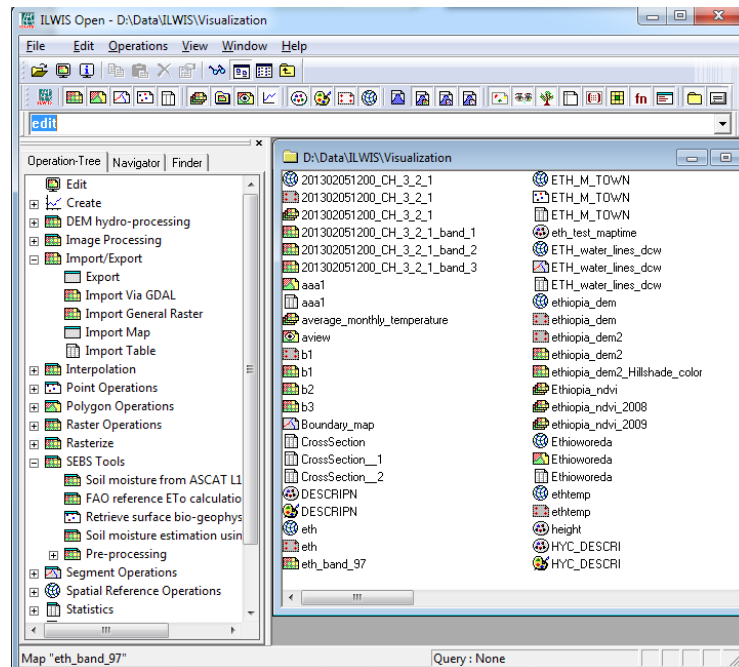

Under each category operations can be found that operate that operate in the same field.

The finder represent all operations as a long list which can be reduced in size by filtering on the name of the operation.

STARTING AN OPERATION

Though there are several ways (see below) to start an operation the most common is to double click on an operation in the operation tree/finder. A Form will then open which you can use to enter the necessary input parameters. For example double clicking the resample operation will show the following

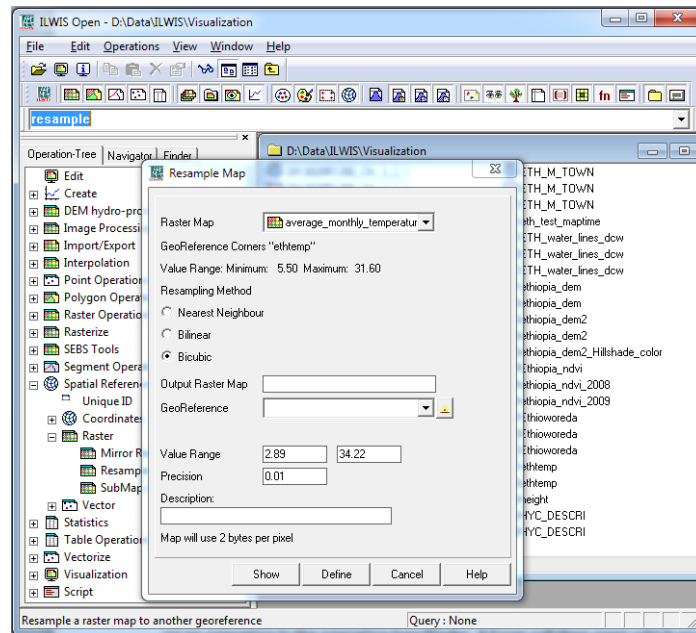

Each operation has its own input form for parameters.

In the form one can enter the various parameters and then either press “define” or “show” (cancel closes the form, help shows the help information about this operations).

“define” stores a definition of the to be created output of the operation on disk. It is not yet calculated but any action that would require access to its data will trigger a calculation.

“show”, calculates the result and shows the result in an appropriate output window (e.g. mapwindow).

We are now going to do an example with “resample operation”.

- 1) Go , in the operation tree, to Spatial Reference Operations → Raster
- 2) Double click on the resample operation
- 3) A form will show similar to the one above
- 4) Select in the combobox labeled “Raster Map” the data file “201302051200_CH_3_2_1_band_3”.
- 5) Select in the combobox labeled as Georeference “ethlatlon”
- 6) Choose a appropriate output name for the (new) raster map.
- 7) Press the “show” button on the bottom of the form

The following (raster) map should show

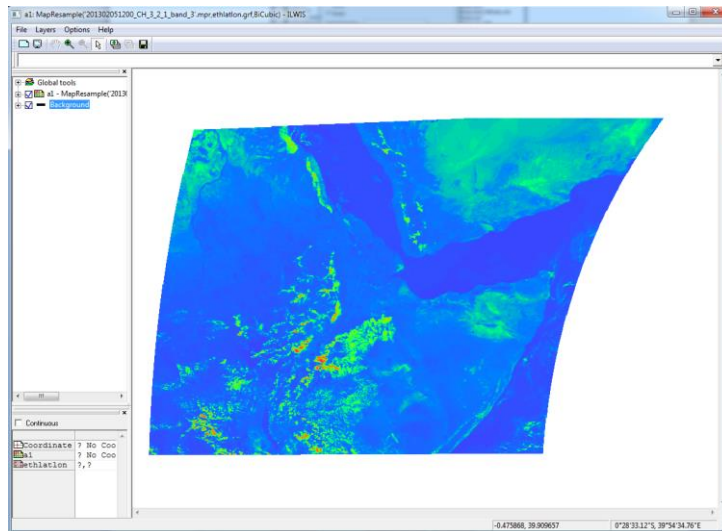

ALTERNATIVE WAYS TO START AN OPERATION

There are other ways of starting an operation

- 1) The context menu of a data object in the catalog. One can use the context menu of a data-object (e.g. a raster map) to get access to operations that are suitable for that kind of input data.

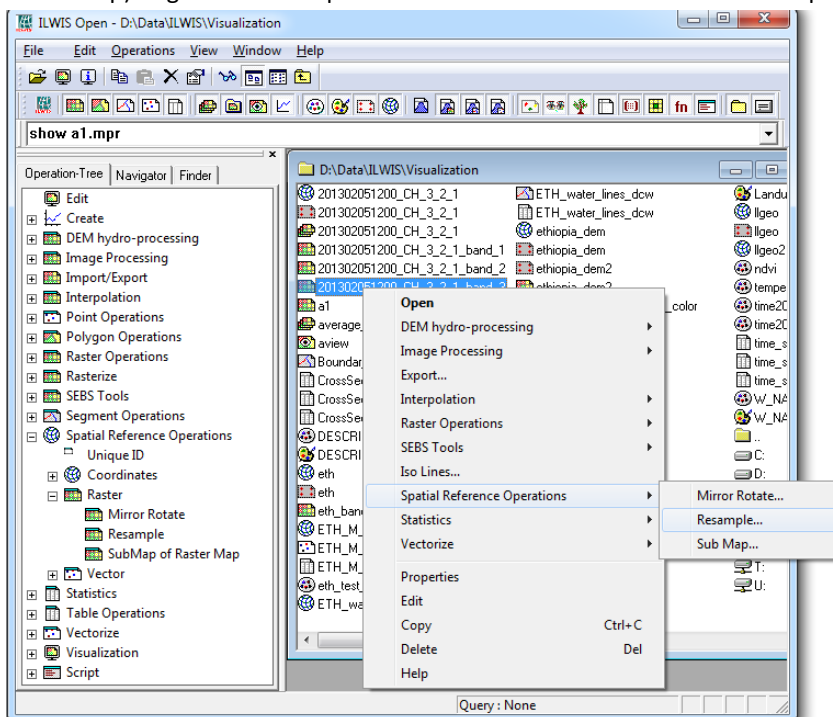

When you press resample the same form will show as the previous example

- 2) Type "res" in the operation finder. The list is now reduced to

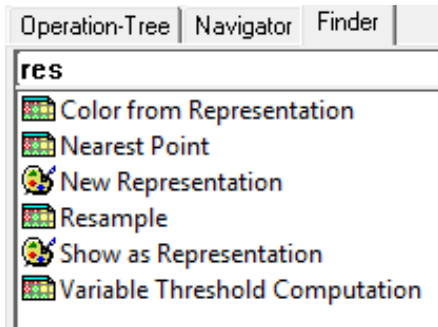

double clicking resample in the list will open the same form

- 3) Type resample on the command line and press return. Again the same form will open
- 4) A special form, called a mapcalc or script statement, can be used when you already know exactly what to do. The script statement is a kind of programming statement that Ilwis uses to calculate maps. MapCalc will be handled later in this document. In this case it will become
*a1.mpr{dom=value.dom;vr=-0.902:19.200:0.000} =
MapResample('201302051200_CH_3_2_1_band_3',ethlatlon.grf,bicubic)*
You won't get a form in this case as all information is already there

COMMANDLINE

In the previous paragraph we briefly mentioned the commandline. Most of the things you can do with Ilwis can be translated to a text expression (see the resample operation mentioned above). These can be executed from the command line or from a dedicated script. Also the history of executed commands is stored in the commandline (it is a combobox).

The commandline supports the scripting language of Ilwis and can be used to execute statements we refer to as "mapcalc" statements. Mapcalc statements are basically simple mathematical expressions applied to each and every pixel in a raster. The operation results in a new raster. E.g. lets calculate the average temperature during the months june and july Ethiopia. In the dataset there is a maplist of the average temperature per month over one year. We can use this to calculate the average. In mapcalc this would be

```
Av_temp = (average_monthly_temperature_june_7.mpr + average_monthly_temperature_july_6.mpr)/2
```

A new map av_temp is created. Mapcalc can be any combination of mathematical operators, functions and Ilwis applications to create your desired output result.

I refer to the help files of Ilwis for a good overview of all the things that are possible with mapcalc.

CATALOG

Ilwis catalogs offer a view on a folder on disk. It shows only the objects/ data sources that are understood by Ilwis. One can have multiple catalogs. There are two important ways to create extra catalogs

- 1) In the navigator go to a folder. Use the context menu and select the "New Catalog" option. A new catalog will open in that shows the content of the folder.
- 2) Go to the Windows (top) menu item. Select the "new catalog" options. A form will open were you can select a catalog for a certain folder.

DATA FILTER

The catalog shows all objects that can be used by Ilwis. This can be, at times, a bit overwhelming as many objects, with many different icons are shown. The data filter reduces this clutter.

The left most button, the Ilwis icon, is a toggle to switch on or off the filter for all data objects.

- 1) Press the Ilwis icon in the data filter. The catalog should then look empty

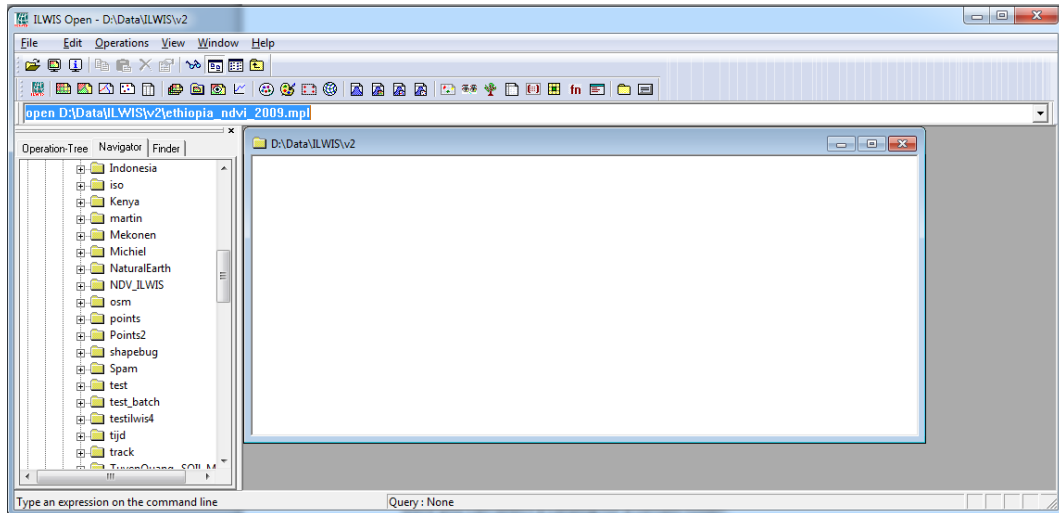

- 2) Press the raster icon (). The catalog should then look like

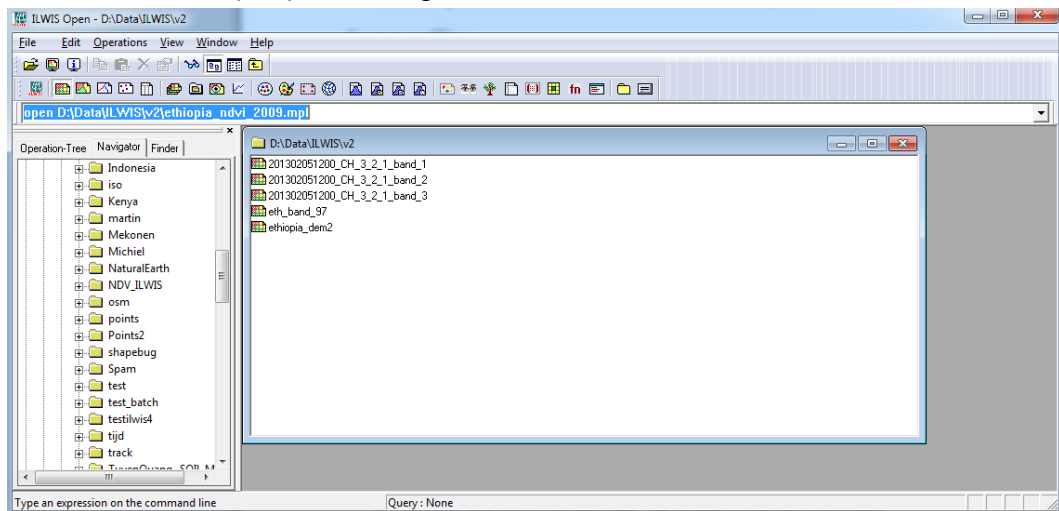

Play around by pressing the various filter buttons.

THE MAP WINDOW

BASICS

The map-window is where spatial data of Ilwis is visualized. One can open a map window by either

- Double clicking on a raster or vector map in a catalog
- Use the main and the “open..” option under the “File” header. You then get a form

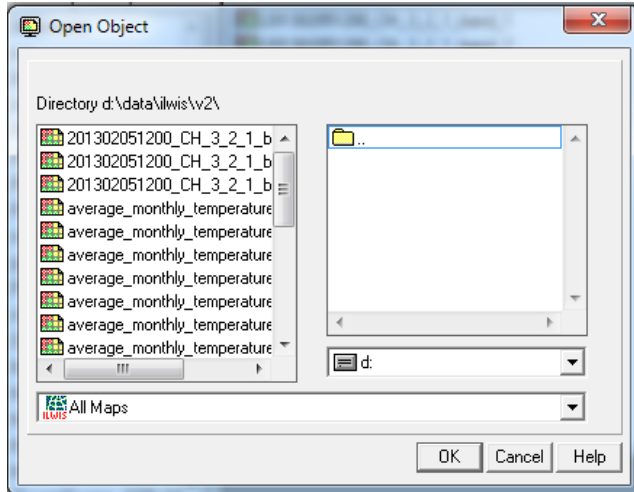

where you can select the map you want to see.

- Use the context menu of a raster or vector map and select the “open” option.

- 1) Double click on the raster “ethiopia_dem2”.
- 2) You should see then

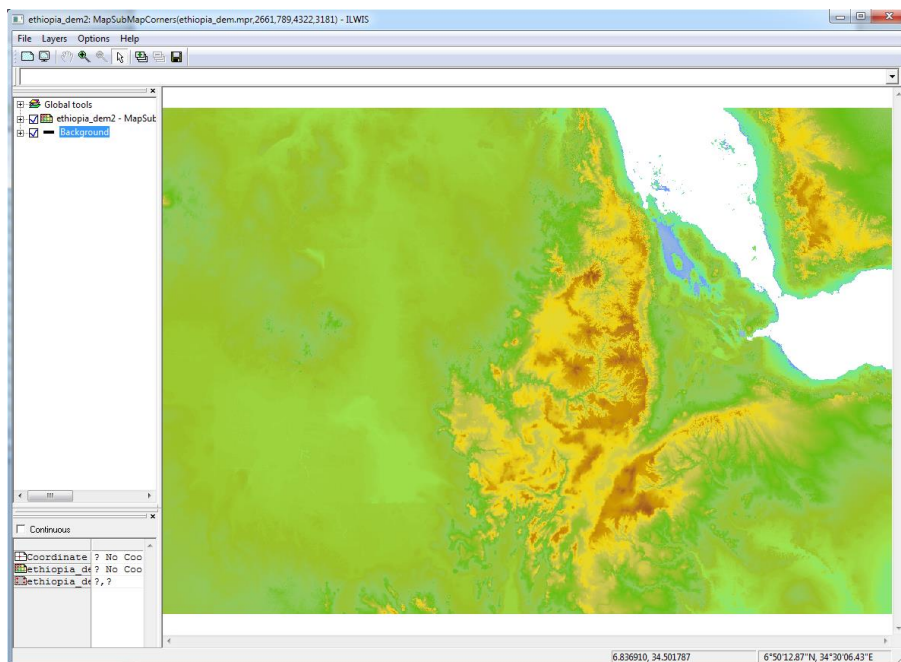

There are several components in the map window

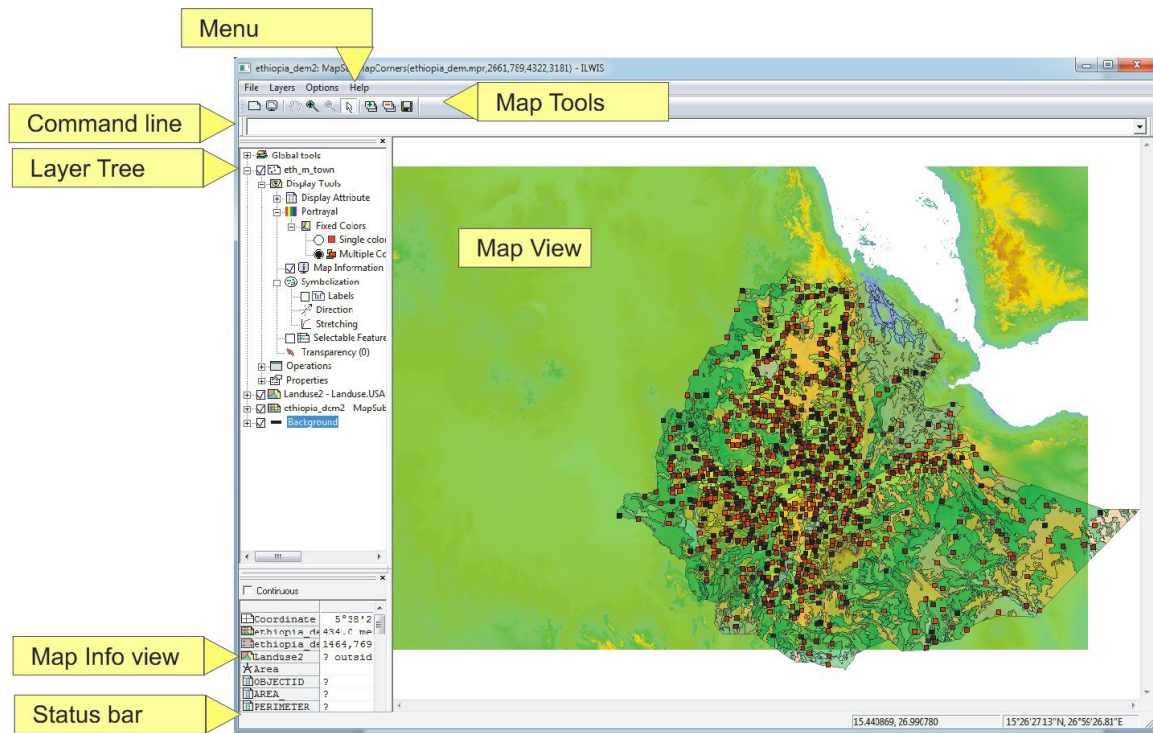

Note that a detailed description of all the functionality of the map window can be found in the addendum at the back of the document.

BASIC FUNCTIONALITY

The basic functionality of the map window (there is of course much more but that is described elsewhere)

- 1) Zoom
- 2) Panning
- 3) Info
- 4) Adding extra layers

ZOOM

Zooming changes the visible extent size of the map window

- 1) Go to the button bar and click the zoom icon ()
- 2) The cursor has changed and move to the map view.
- 3) press (and keep pressed) the left mouse button and draw a rectangle.
- 4) release the left mouse button and the display changes to the zoomed area.

One can zoom out by pressing the zoom out icon (). Drawing a rectangle on the map then centers the zoom out on the center of the rectangle.

PANNING

Panning changes the location of the visible extent of map window.

- 1) Zoom in on the map
- 2) Go to the button bar and click on the pan icon ()
- 3) The cursor has changed. Left click on the map view and keep the button pressed
- 4) Move the mouse cursor around and the map will follow

INFO

With info one gets information of all the layers beneath the location of the mouse cursor. This is only enabled if the map window is in “normal” mode (the default). This means it is not in zoom-in, zoom-out, or pan mode.

- 1) Go to a location on the map and press the left mouse button.
- 2) Keep it pressed and move the mouse around
- 3) You will see a small rectangle with the current attributes/pixel values of all the layers below the mouse.

Detailed information can be found in Map info view on the left

ADDING EXTRA LAYERS

The map window can handle multiple layers from different geometries and data types simultaneously. Adding a layer is possible in several ways.

- Drag and drop a map from the catalog from the main window to the map window. If the new map and the old map are roughly in the same area (they overlap somewhere) it will display on top of the already present layer(s). Select the “Landuse2” polygon map and drag & drop it to the map window
- Go to the “layers” menu of the map window and select the “Add layer...” option. A form will show where you can select your layer to be added. Select the polygon map “Landuse2” and add it to the map window
- In the map window and in the layer use the context menu (in the white area below the layers) to add layers. It is similar to the previous option. Select the polygon map “Landuse2” and add it to the map window

Removing a layer can be done by using the context menu of the node in the Layer tree. The remove option will remove the layer.

The order of the layers can be changed by dragging the icon of the layer whose order you want to change in between the layers where you want it to be positioned (or at the end).

MANIPULATING THE VISUALIZATION

Though the a full description of all the options in the map window can be found in the back of the document we will construct in this section a view which contain several layers and then using several tools to change its appearance and analyze its content.

- Open the raster “eth_band_97” in a map window
- Add the polygon file “Landuse2” to it
- Add the point map “eth_m_town” to it.

You should get something similar to this

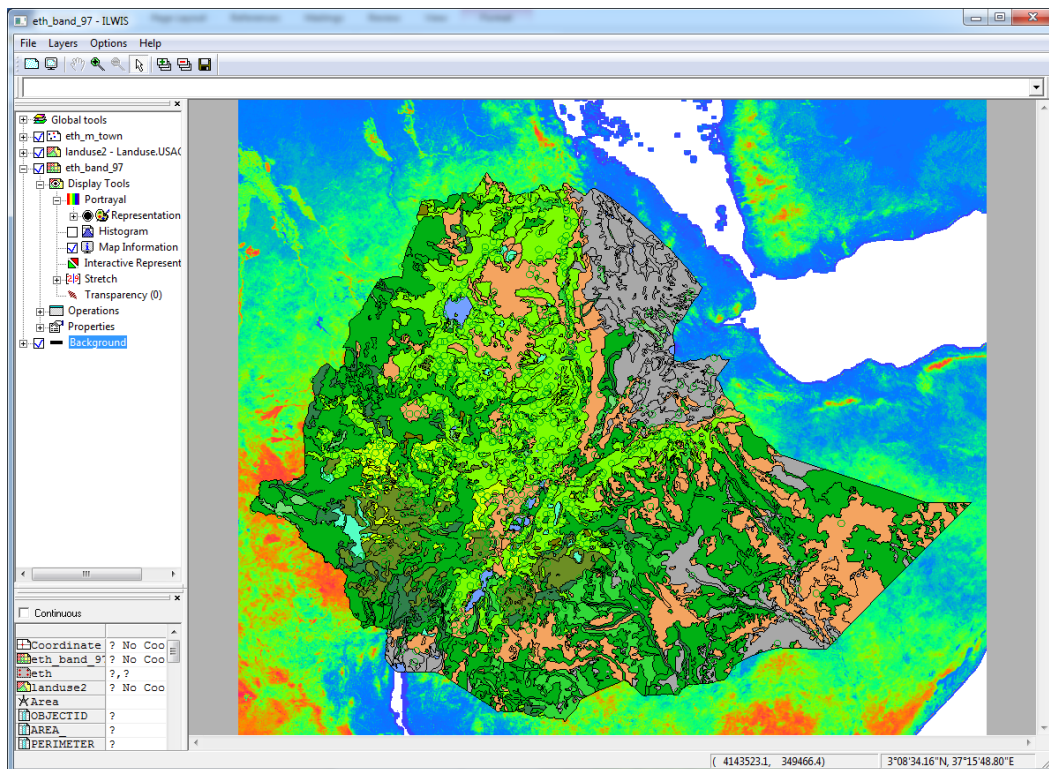

Now we are going to change the appearance of some of the layers. First the raster layer “eth_band_97”.

- 1) Click on the “+” sign before the layer. It will now expand and show three (sub) nodes. Click on the “+” of “Display Tools”. The display tools contains all the tools for manipulating and analyzing the layer. In this case we want to alter the coloring of the raster from the current coloring to a grey based coloring.

- 2) Click on the '+' of "Portrayal" and double click on the "representation" node. A small form will open with a combobox. Select "Gray" and press apply. The result will be

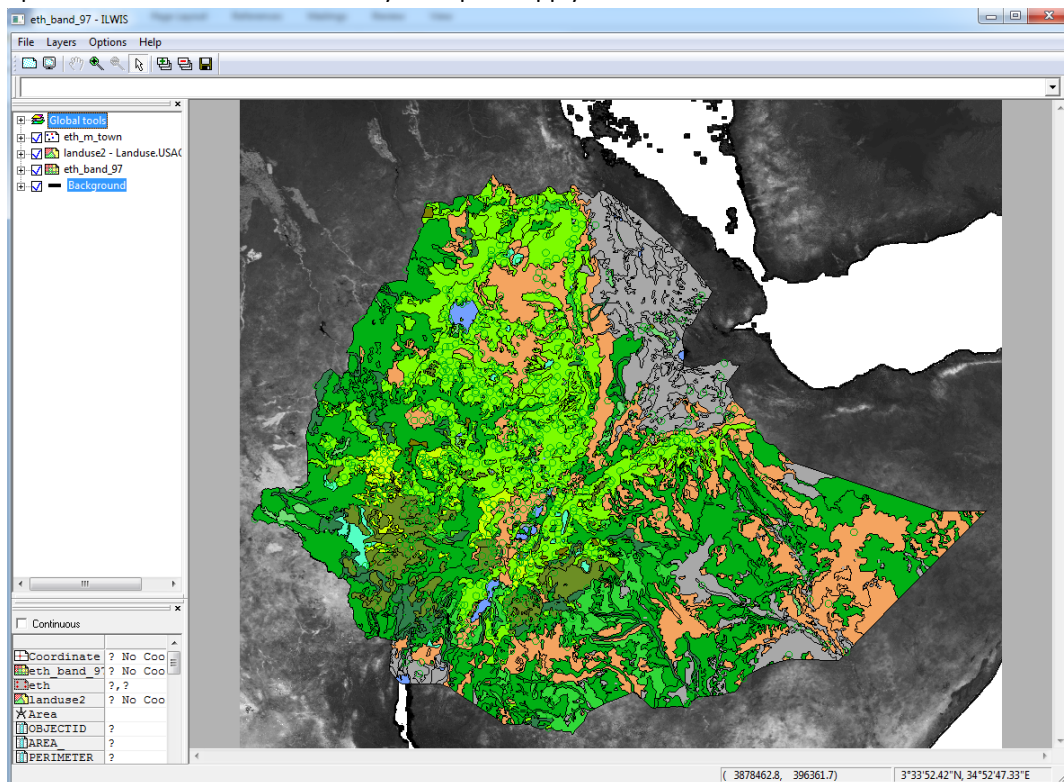

Next we are going to change the transparency of the areas and the color of the boundaries of the polygon map

- 1) Like in the previous example, go to the "display tools" of the layer "Landuse2".
- 2) Click on the '+' before areas. One node that is shown then will be the "transparency". Double click on the text.
- 3) You will get a small form where you can either type in the new transparency value (between 0-100) or use the slider. Set it to 50.
- 4) Next we are going to change to color of the boundaries of the polygons.
- 5) Click on the '+' before "Boundaries" and double click on the text "Line style". A form will open where you can change properties of the boundaries. In our case we are only interested in the color. Use the combobox to select "yellow" and press apply.

6) You should have something that looks like

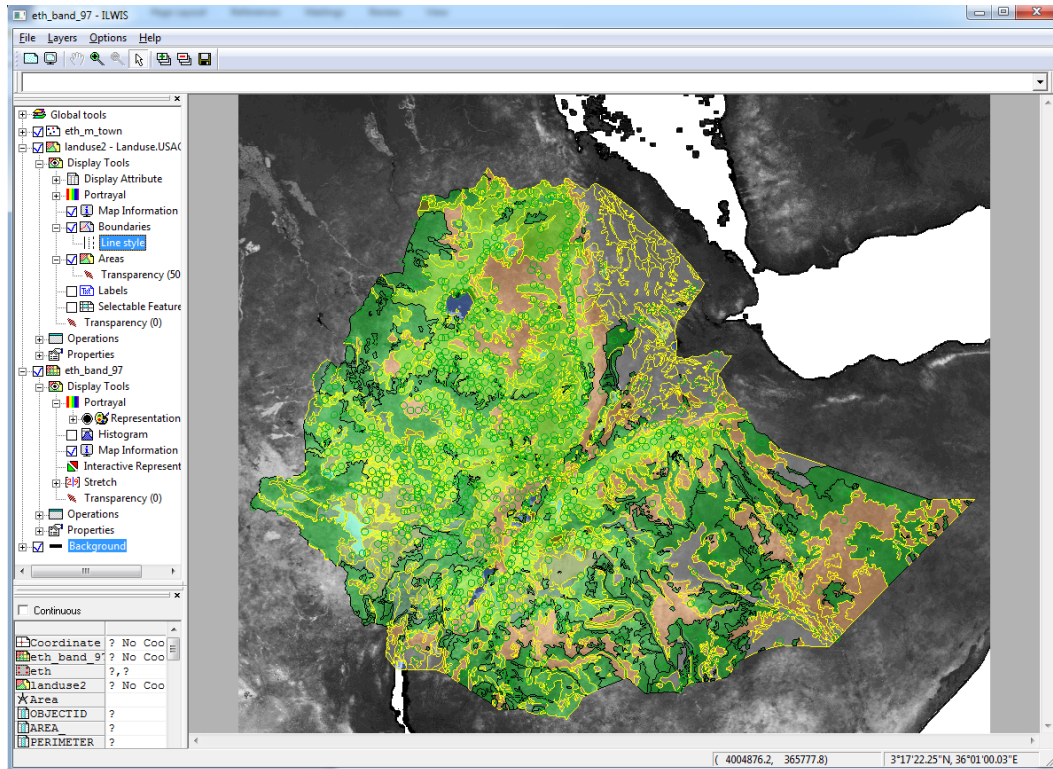

7) Close the form

Next we are going to change the appearance of the point map "eth_m_town"

- 1) Like in the previous example, go to the "display tools" of the layer "ethm_m_town".
- 2) First we are going to change symbol we use for the points (now an open circle, bit hard to see on the green background).
- 3) Double click on the "symbolization" node
- 4) We get a small form in which we can change the properties of the symbols in the map. In this case we want to change to symbol type. Use the combobox labeled symbols and select "filled-rectangle".
- 5) Press apply and close the form.
- 6) Next we are going to change to coloring
- 7) Go to the "Portrayal" node and open there the "Fixed Colors" node.
- 8) Change the "single" color radio button to "Multiple colors"
- 9) Double click on the fixed color node. You will get a form in which you can change the properties of the (fixed) colors of the points. Select the color scheme "red" and press "Apply". You should get a result that looks like

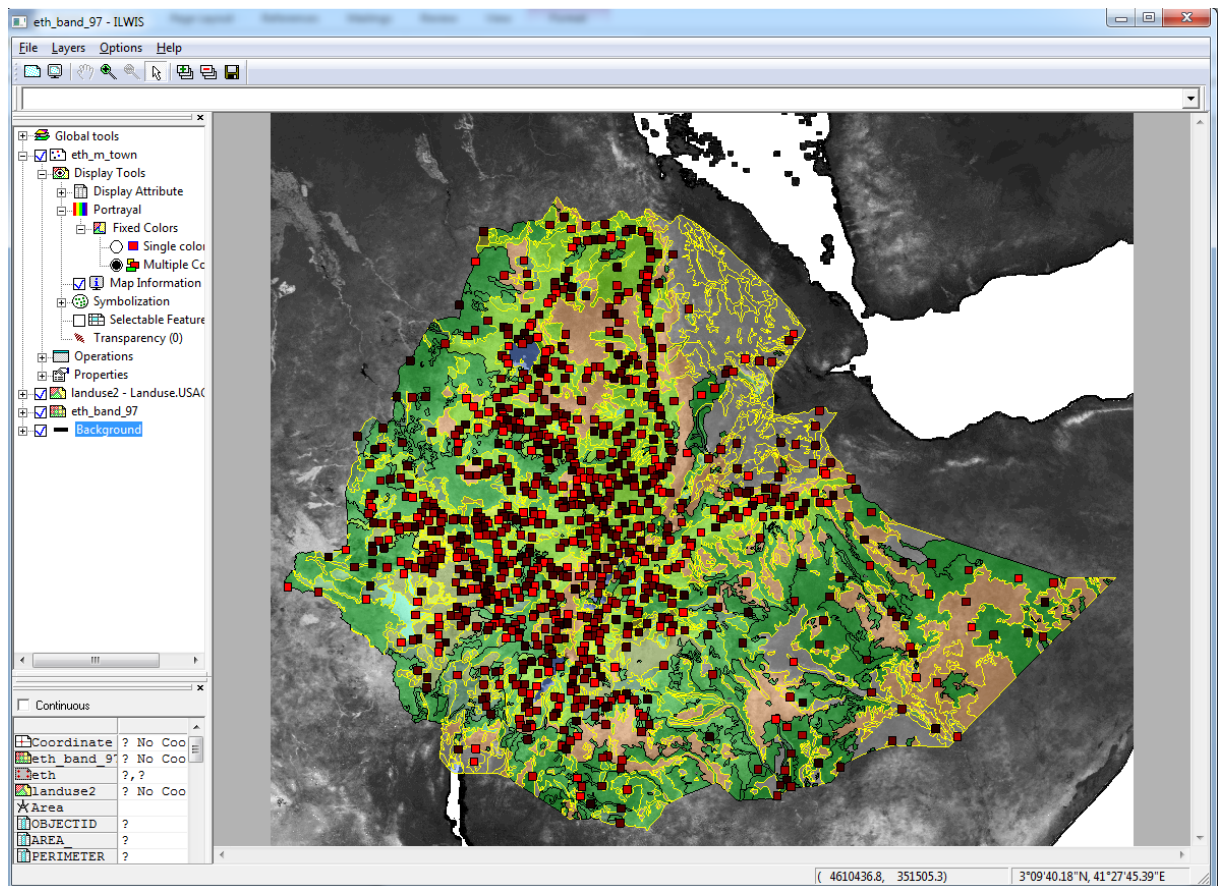

There is much more to say about all the properties that can be manipulated (again, see the addendum) but I leave that up to the user. The general principles are the same for all

ANNOTATIONS

With annotations we decorate the view with meta data to enhance the communicative value of the view when it is included in other documents or presentations. We are going to add a scale bar and a legend (of one of the layers).

To make some room for the we use the extend map functionality of Ilwis.

- 1) Go to the "Options" in the menu of the map window.
- 2) Go to extend window → by percentage
- 3) Extend the bottom by 20 %
- 4) Now there will be a white area below the map which can be used to place annotations

First we add a legend

1. Go to the display options node of the layer "eth_band_97".
2. Use the context menu. You will see a menu with all the (display) tools that are currently activated. You will also see a number of tools that are not activated by default. One of them is "Annotations".
3. Active "Annotations".
4. If you now open the Display options node you will see a node below it called "Annotations". Open this node and check the legend box
5. Open the legend node and double click on "Appearance". A form will appear.
6. Fill in as title "Legend of eth_band_97". Press apply and close the form

7. Double click the “Size & Position” node. A form will appear. Set the number of columns to 2 and position the legend on x = 20% and Y=5%. Use horizontal for the orientation. Press Ok.

Last we will add a scale bar

- 1) Go to the “Global tools” in the layer tree and open it.
- 2) Go to the annotations node and open it.
- 3) Check scale bar.
- 4) A scale bar will appear but it is not at the correct position. Double click the scale bar node. In the form change the position x=20% and y = 4%. Furthermore change the ticksize to 200.000.
- 5) Press apply and close the form.

Now you should have a view that looks like this:

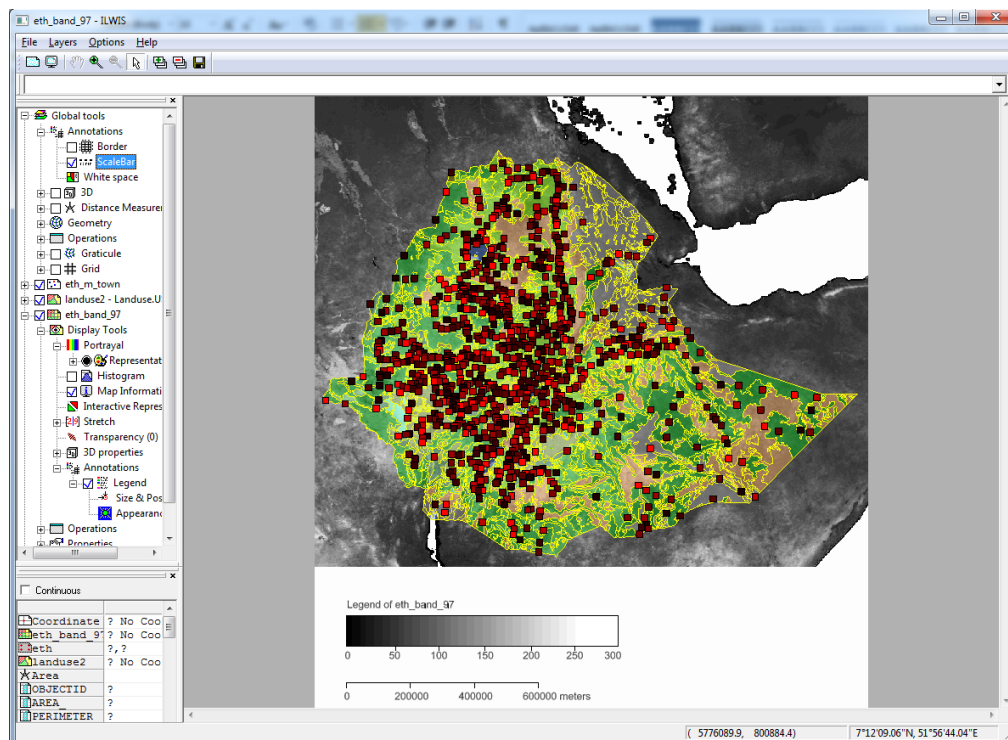

PRINTING

Ilwis doesn't have separate method for printing views. Instead it relies on the copy/paste mechanism of windows. Views can be copied at any dpi and pasted in any package that accepts images and printed from there. As a standalone view or as part of a larger report. Note that it might be a good idea to switch off the background as this will remove the grey borders around the map.

- 1) Go to the layers menu from the map window.
- 2) Select “Copy”.
- 3) A form will open in which you can enter the desired size of the image and its dpi. The default is at 300 dpi and should be sufficient for most purposes. Bigger dpi means (much) bigger images.
- 4) Press ok.
- 5) Open a program where you can paste images and paste the image. The result should be the same as picture above.

ANIMATIONS

Ilwis can animate sequences of images in a map list in a layer in the map window. One can control things like speed, zoom levels, display properties etc... As far as Ilwis is concerned the animated layer is a normal layer and all the tools that work (and are reasonable to expect) on a single layer also work on a animation.

- 1) Though there are several ways to start a map list as an animation we use the one through the context menu. Go to the map list “average_monthly_temperatures” , use the context menu and select the option “Open as animation”
- 2) A map window will open with a layer with the same name. Go to the “Display Options” node and open it.
- 3) Double click on the “Run” item. A form will open which controls the main properties of an animation.

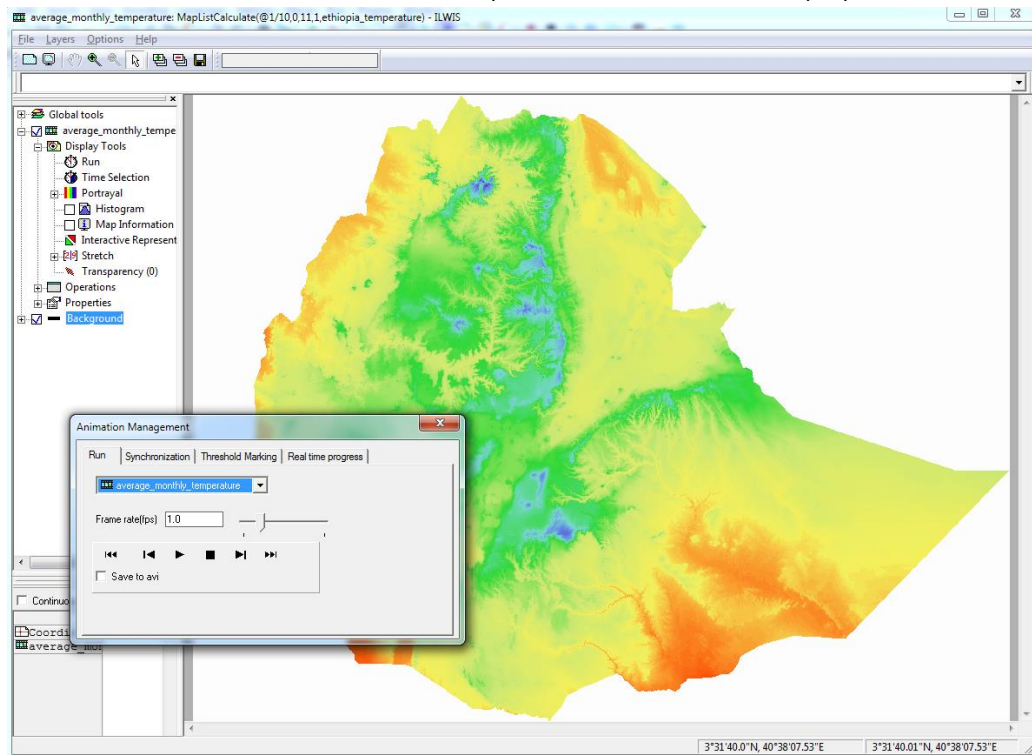

- 4) Press the run button (▶). The animation will now start to run at 1 frame per second (fps)
- 5) Move the slider so that the fps is three. The animation will no run noticeably faster
- 6) Press the pause button (⏸) to pause the animation
- 7) The animation can also move per frame basis. To do this use the step button (forward, backward, ⏪, ⏩) to move one frame.

There are many more things you can do with animations but I refer to the documentation in the addendum were all those properties are described.

To illustrate that the animation is just a normal layer.

- 1) Add the layer “Eth_M_Town”
- 2) Query the information on one of the added points by moving the mouse cursor to a point and pressing the left mouse button. The value of the point and the animation(raster) will now be visible. As long as you keep the button pressed it remains constant but if you toggle it you will see it changing in sync with animation below it.
- 3) Look at the Map Info pane on the left bottom side and you will see the animation value changing constantly.

Based on Ilwis 3.8.5

INTRODUCTION

Ilwis 3.8 saw a massive change in how layers are drawn in the Ilwis map window. The 3.8.1, 3.8.2, 3.8.3 were incremental versions, improving and slightly extending the model that was introduced in 3.8. This document contains a description of all the options that are available in Ilwis 3.8.3 for the visualization of spatial data sets. It is not intended as a tutorial but more like a reference document.

The document is divided into five sections

1. Map window

It describes the general features of the Map window. Its layout and content

2. Display tools

The general set of tools and (visual) operations that one can do on the layers of the map window

3. Global tools.

General display tools that apply to the whole set of layers.

4. Special tools

Specialized tools that focus on one fairly limited type of visualization and need not to be active in most cases.

5. Addenda

A small set of more technical oriented sections about how to extend some of the functionality of Ilwis.

Each section describes a part of the map window user interface and enumerates over the options available there. It usually illustrates it with an example.

MAP WINDOW

A map window consists of the map view, the layer tree and the map info. The map view displays the spatial data sets, and any tool items if appropriate (see for example : 'Profile' or 'Region of Interest'). The Layer tree controls all display options of all the items in the map view. The map info view shows extended information about features or pixels in the map view.

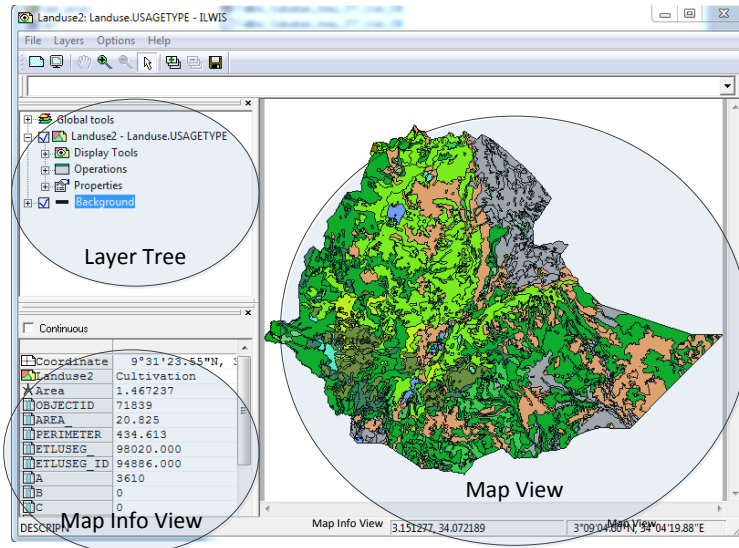

Apart from these main parts of the map window there are a number of “auxiliary” parts

- Map window menu.
 - File; creation of mapviews on disk and some special operations
 - Layers; additions of new layers and
 - Copy. This is an important menu option as it copies the entire content of the MapView to the clipboard as a picture (300 dpi resolution). This picture can then be pasted in any document or other container for printing or other purposes.
 - Options
 - Some of the options are
 - Zoom In/Zoom Out/Pan
 - Entire map, shows the layers in the its full extent
 - Histogram. A small histogram of the current layers. See also under Special tools “Histogram”.
 - Full Screen. This removed all UI elements and makes the map view full screen. No layer tree, no map info, only the mapview without any borders(scroll bars may be there if needed).
 - Metric coordinates. If a layer has a geographic coordinate system the coordinate boxes on the status bar would duplicate information. With this toggle one can force the left box to show geographic coordinates as decimal numbers. This is convenient in some situations.
- Status bar. The status bar shows to the right two coordinate boxes. The right one will contain the geographic coordinates, the left one the projected coordinates (or also lat/lon if the system is not projected).

MAP VIEW

The map view is the container for all the spatial information in Ilwis. It can contain

- Regular spatial data sets as layers (raster, point, segment and polygon)
- Animations. Any ObjectCollection or MapList can be used as animated layer where each element of the collection/list is displayed in order.
- Tool items. Tools are the actors that define how the elements of a mapview are rendered. Some tools render themselves. E.g. a zooming rectangle or a line for the distance tool.
- Tooltip information. The mouse cursor may display info at the click location or continuously about what is below the mouse. More complete info can be found in the Map Info (see 'Map Info view').

Coverages are displayed in order of the Layer tree (see 'Layer Tree'). The top layer is the top layer in the Layer tree.

The visibility (rendered or not) of a layer can be controlled by the check box in front of the layer.

ZOOMING

With zooming one increases or decreases the viewing scale of the contents of the Map view. There are two ways of zooming. First of all one has to press the zooming  icon on top of the window to enter the zooming mode. Then one can either

- Draw a selection rectangle on the Map view that represents the area to be enlarged.
- Click on the map and the map will zoom in on that location by a factor of $\sqrt{2}$.

In both cases the aspect ratio of the map will remain the same.

If the zoom-out icon  is used, the map will zoom out a factor $\sqrt{2}$.

Zooming is disabled in the 3D mode as this functionality is accessed in a different way there (see '3D Visualization').

SCROLLING

Scrolling works as usual in windowed applications.

PANNING

Panning is activated by the panning icon  on top of the window. The mouse cursor changes to a hand and one pressing the left mouse button the visual center of the Map view follows the cursor.

GEOMETRY

Ilwis is able to do on the fly reprojections and is resampling the layers in the map view. This means that Ilwis does not care about the geometry of the spatial data sets added to the map view. It will transform them to geometry of the map view (coordinate system/projection) as long as a suitable transformation is available¹.

¹ Take care when using coordinate system "unknown". It may not display properly because its forward and backward translations to other coordinate systems is not defined.

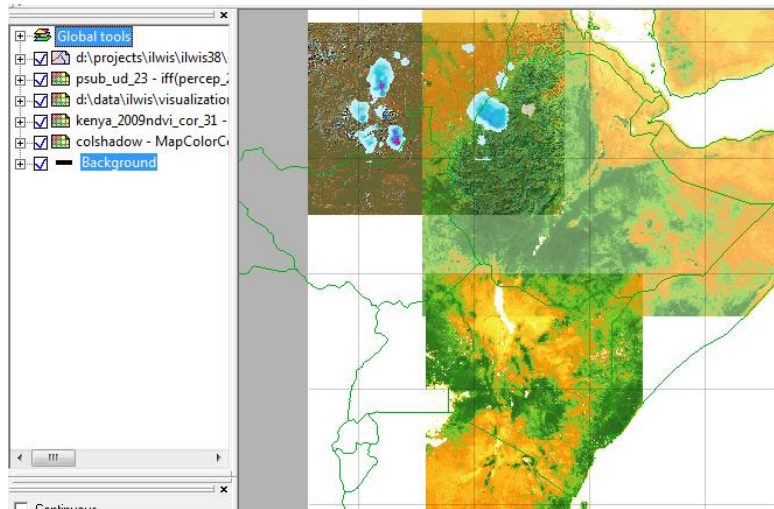

In this example 4 rasters and one segment map with different coordinate system and georefs are dropped on the map view and are automatically resampled and reprojected to form a mosaic of the 5 spatial data sets.

The geometry of the map view is determined by the **first** map added to map view. All other layers will morph to this geometry. One can change this by using the geometry tool of the global tools

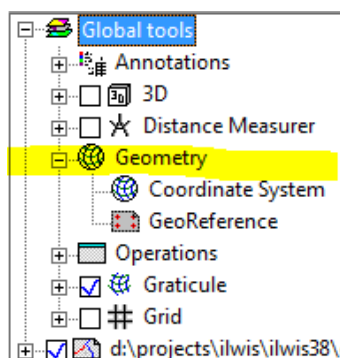

Double clicking on the Coordinate system tool will show a simple form to select another coordinate system. The coordinate system chosen will be the new coordinate system of the map view and all layers will adapt to this.

LAYER TREE

The Layer tree represents the (visual) properties of all the spatial data sets and the global properties of the Map View. It offers a hierarchical view on the layers and their properties. The properties are accessed by the display tools (or “tools”). Tools can be sub divided in:

- Controlling display properties. For example transparency of polygon areas or the stretch range for numerical maps.
- Adding extra functionality. For example distance tool or profile tool
- Selection. For example zooming or feature selection

Each layer has a number of tools, operations and properties associated with it that are applicable to that type of layer. The polygon layer for example has a tool associated with it to control the appearance of the areas of the polygon map. The same tool would make no sense in a raster layer and is absent there.

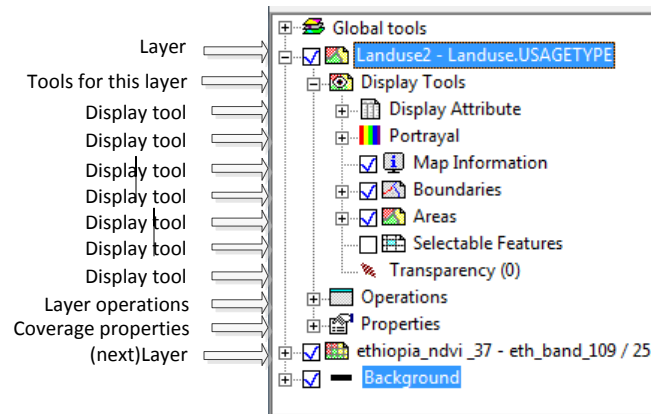

Not all tools are visible by default. Some more specialized tools are not switched on by default. You can activate them by using the context menu of the node labeled “Display Tools”. A context menu with check marks (indicating active or not) becomes visible and one can add or remove tools from the active tools.

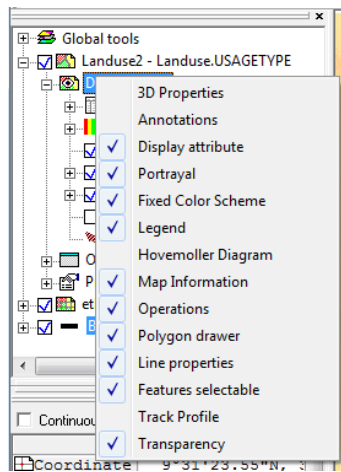

Properties of a node in the layer tree can usually be reached by either double clicking on a node or by directly changing the state of a node. The latter case is for toggles (visible or not, selection). Some nodes may not have properties as they are organizational nodes, but then their child nodes will have properties.

The global tools tree item at the top of the Layer Tree represents properties that effect all layers. For example: 3D tools switches to a 3D perspective for all layers. One cannot have some maps in 2D perspective and some in 3D perspective.

There are three other nodes in the tree

- Operations. This is a sub set of the normal operations tree of the mainwindow that contains only operations that are relevant to the type of layer. Any operation that generates a spatial data set will automatically add the generated spatial data set to the layer tree(and map view).
- Properties. This accesses the spatial data set properties. Double clicking on it will open the regular property form of this type of spatial data set.
- Background. The background is the canvas were all layers are stacked upon. It has two areas. An area that is outside the extent of the map view and an area that is inside the extend of the map. Both can have different colors. Furthermore there is a transparency. In 3D mode, the background is always at 0 height. It is possible to have (part of) layers below the 0 level depending on the z-offset of the layer.

The Layer Tree is a floating dockable window that can be docked anywhere on the mapwindow (or closed)

MAP INFO VIEW

The Map Info view gives a user access to detailed information about features/pixels under the mouse cursor in the map view. It combines information of all layers and associated attribute tables into one view. The view has two modes of operation, continuous and non-continuous. In the continuous mode it fetches information as the mouse moves over the Map view. In non-continuous mode it only fetches information when one clicks on a location.

The view shows information

- The coordinate under the mouse cursor
- For each layer
 - The name of the spatial data set
 - For segments : length of the line
 - For polygons : area of the polygon
 - For Raster : Pixel location in the map
 - If there is an attribute table associated with this spatial data set
 - All values of the attribute columns

Field	Value
Coordinate	5°38'25.91"N, 40°10'10.00"E
Landuse2	Shrubland
Area	0.675396
OBJECTID	120566
AREA	17.607
PERIMETER	406.804
ETLUSEG	147268.000
ETLUSEG_ID	150830.000
A	13293
B	0
C	0
D	0
FREQUENCY	116
DESCRIPN	Open shrubland
LANDUSE	82 0 0
LUT	1858
USAGETYPE	Shrubland
Count	163
Ethiopia_n	0.36
Eth	1198,1006

The Map Info View can be customized through the context menu of the view. One can

- Add spatial data sets that are not part of the Map view. In this way one can inspect values of (spatially) related maps that need not to be visible in the Map view
- Add Coordinate system. Useful for inspecting what transformed coordinates would be in a different Coordinate system.
- Add Georeference. Useful for inspecting (in the case of rasters) what pixel location would be associated with certain coordinates
- Customize. Mainly switching on/off which info you want to see in the view (attribute columns, coordinate info etc..). Default everything is on.

The Map Info View is a floating dockable window that can be docked anywhere on the mapwindow

DISPLAY TOOLS

COLORS

The colors of features or pixels in Ilwis is controlled by either the representation or by the independent coloring. All viable map domains, apart from domain ID/Uniqueid, have an associated (default) representation. Domain id/uniqueid has no representation and their coloring is predetermined (see 'Fixed Colors').

The used representation can be changed.

REPRESENTATION

The representation used can be found under the portrayal node in the Layer Tree.

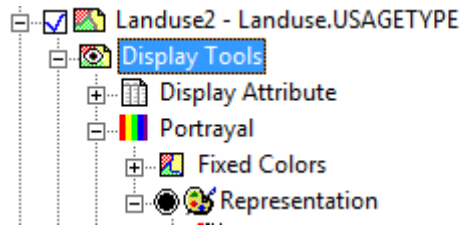

The representation includes a legend to show the actual meaning of the colors. Double clicking the “Representation” tool opens a small form which one can use to select another appropriate representation. Note that for gradual representations this is of course an approximation as the range is divided in steps.

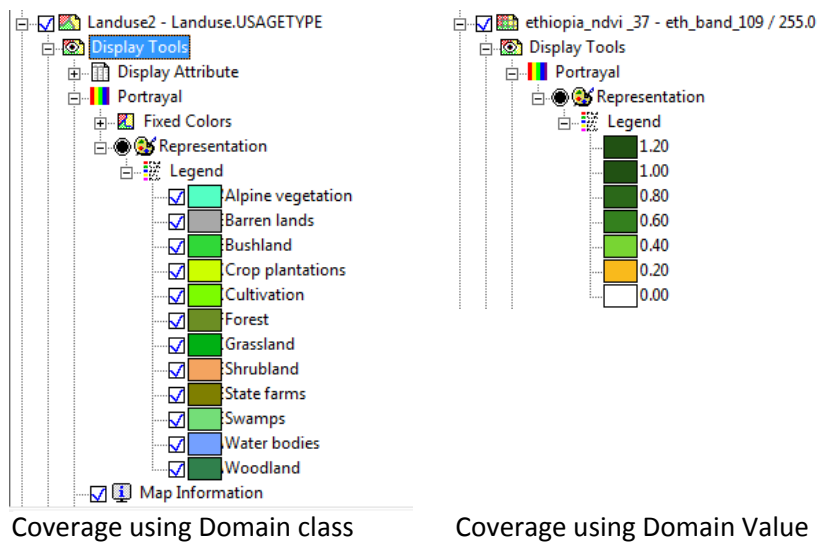

For class maps the legend has additional functionality.

- One can toggle the visibility of specific classes in the map view by using the check mark

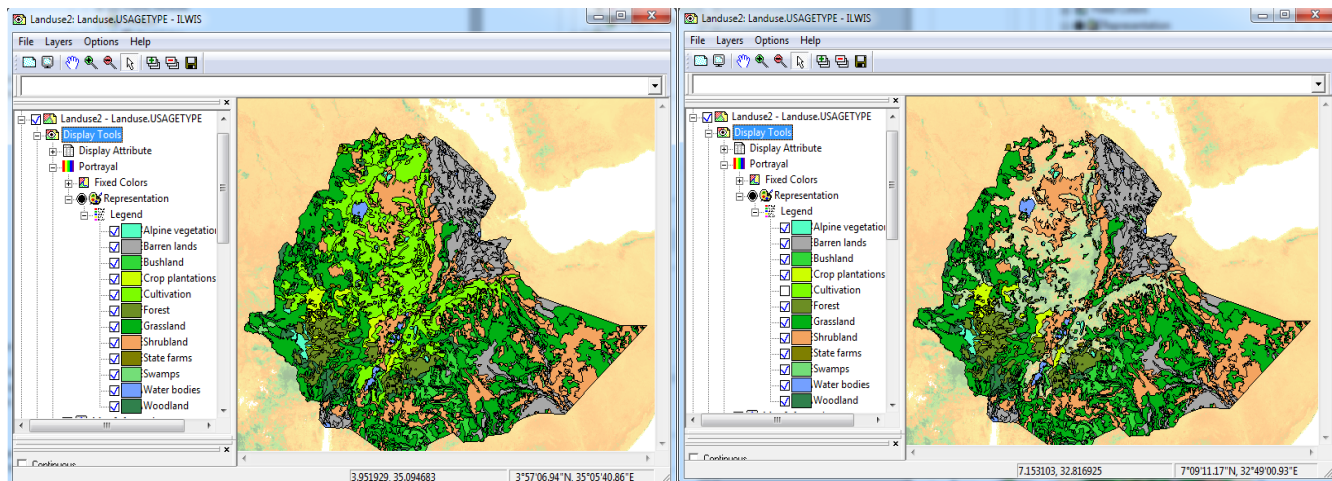

Right map has the “cultivation” class turned off and consequently they are not rendered anymore.

- One can open a representation editor for a specific class item by double clicking on the item. This opens a form that shows the properties that can be changed. E.g. for a polygon class item

Note that the legend for class items has its limitation for what it represents in the Layer Tree legend. It only shows the main color of the legend item (so no hatching for example). It is only an indicator, not an exact replica.

The representation used can be changed by double clicking the representation tool under the portrayal node in the Layer Tree.

For value maps the legend (node) can be double clicked and ranges and step sizes can be changed, overruling the default

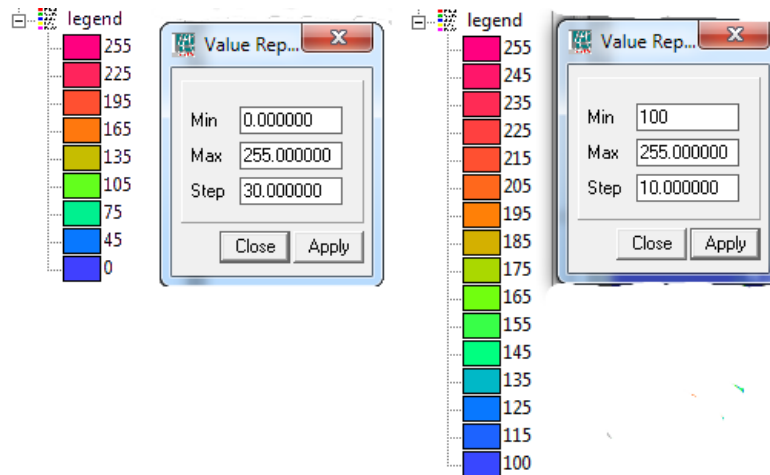

In the example above the default (left) has been overruled with a different set of values. The map has also been stretched and this is also reflected in the legend.

FIXED COLORS

This tool forces the colors to be either one fixed color or a fixed set of multiple colors (only domain id/uniqueid).

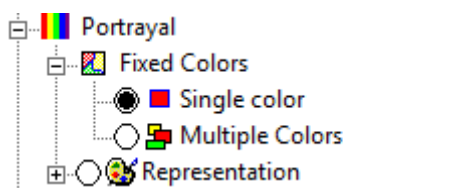

The single color option forces all features to be drawn in the same color irrespective of representation or other color options. Double clicking the tool "Single color" tool produces a small form to select a other color.

The second option, "Multiple colors", is only available for layers using spatial data sets with domain id/uniqueid. It colors the features by selecting colors from a limited palette of colors and cycles through these colors. The palette can be 8,16 or 32 entries big. This is useful for domains with a big number (say 10000) of identifiers where it's important to recognize the (visual) distinctiveness of features but the exact color is without meaning.

As usual, double clicking produces a form to set properties

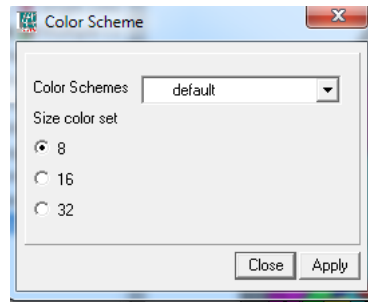

The combobox, “Color schemes”, produces a list of possible schemes. Changing the scheme, changes the look of the map. In the picture below you see the change between the “default” scheme and the “desert” scheme. Note that is not a representation replacement as domain id maps do not have a representation. It is possible to modify and add schemes (see appendix ...).

The radiobutton determines the size of the palette. The default choice of 8 is usually sufficient to get visual distinct features in large sets.

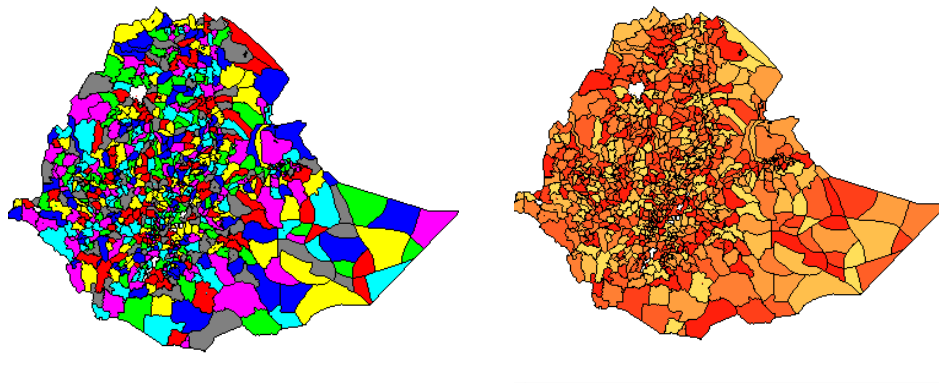

ATTRIBUTE TABLES

Class or id spatial data sets may have an associated attribute table. Default the coloring of the layer is based on the spatial data set value of the feature/pixel but one may select one of the attribute columns to “do” the coloring. Only columns with domain class/id/uniqueid and value are eligible for this. The selection may look like this

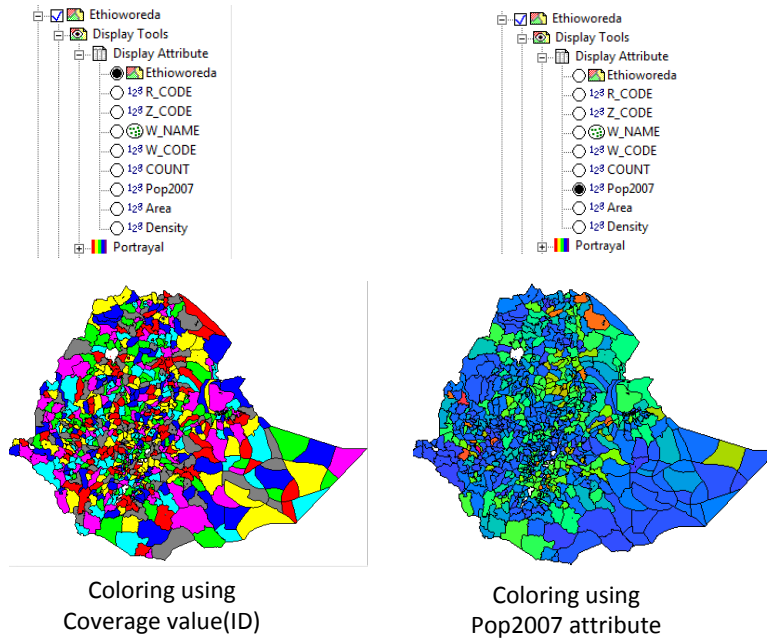

The icons before the column names indicate either domain value (the small numbers), domain class/id (the small venn diagram) or the layer it self (the map icon).

TRANSPARENCY

Ilwis allows transparency at many levels and elements. Ilwis allows transparency of

- Layers
- Areas and/or boundaries of polygons (will be described when polygon layers are described)
- Representation class items
- Grid/graticule

LAYER

The transparency of the layer can be set by the transparency tool

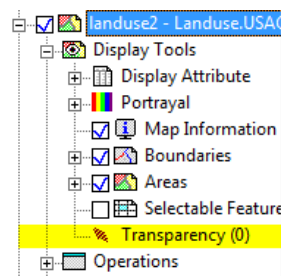

It controls the transparency for an entire layer and can range from 0 (no transparency) to 100(full transparency). Double clicking it opens a small form(2 possibilities)

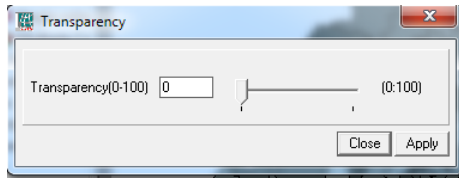

All coverages but value coverages

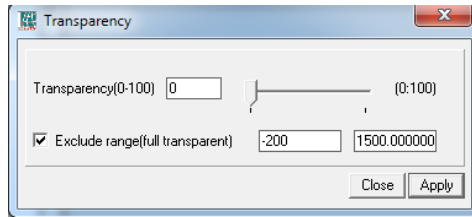

All value coverages

The first one is fairly straight forward and changes the transparency for the whole layer (on the fly, while one is moving the slider). The second one does the same but has an extra option, "Exclude range". If checked, and the range is set, one excludes all values within the range specified. The effect is, for example, that for raster only part of the raster is drawn.

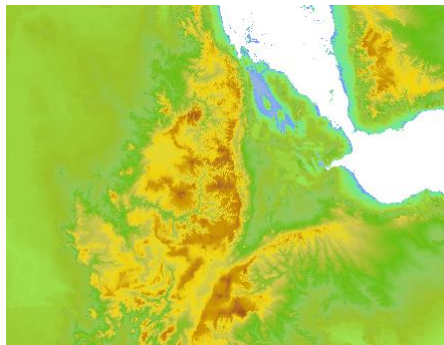

Dem Ethiopia, no exclusions

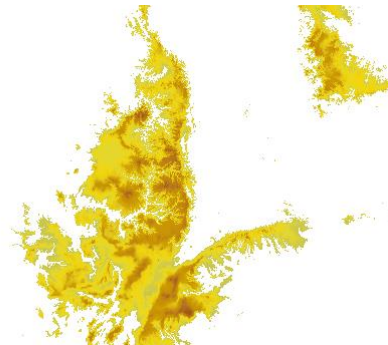

Dem Ethiopia, excluded range
-200, 1500

Note that the white area in the second picture is 100% transparent and anything beneath it will be fully visible.

STRETCHING

Ilwis calculates default stretching range for value maps but this may not always be the desired stretch range. The stretch range can be dynamically altered to fit one's wishes. As usual the option is reached by double clicking the appropriate tool

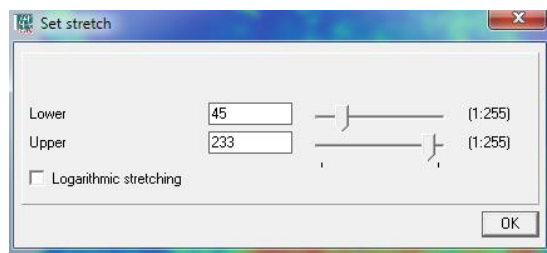
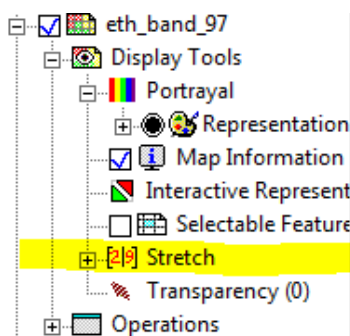

One can alter the lower and upper stretch values and this will alter the rendered map on the fly. Note that stretching only works for layers using RepresentationGradual as this representation is able to dynamically rescale the colors as its range changes. Fixed representations have of course always the same color for each value (that's why they are fixed). Stretching of course also works on visualizations of (value) attributes of a layer.

MAP LAYERS

The Map View has seven possible layer types that be displayed

1. Raster layer
2. Point layer
3. Segment layer
4. Polygon layer
5. Animation layer
6. Collection layer
7. Base maps

Each layer type has different visual properties that can be set by dedicated tools for that type of layers. There are many tools that are shared by all layers (e.g. transparency).

There are three ways of adding maps

- “Add layers...” option in the layers menu item in the menu of the map window. A form will appear to select the spatial data set to add. The filter box will filter the list based on type of the spatial data set. There is one special filter there “Base maps”. As such basemaps are normal spatial data sets, except for the OpenStreetMap layer. BaseMaps are world wide coverages that are always present in ILWIS and can be added to all Map Views. They are meant as support maps. ILWIS has four base maps by default
 - Cities. with attribute information
 - Country boundaries.
 - Rivers.
 - OpenStreemap tilemap. Adds an openstreetmap (tiles) layer to the mapwindow. Usefull as backdrop. To use this one, one needs an internet connection.

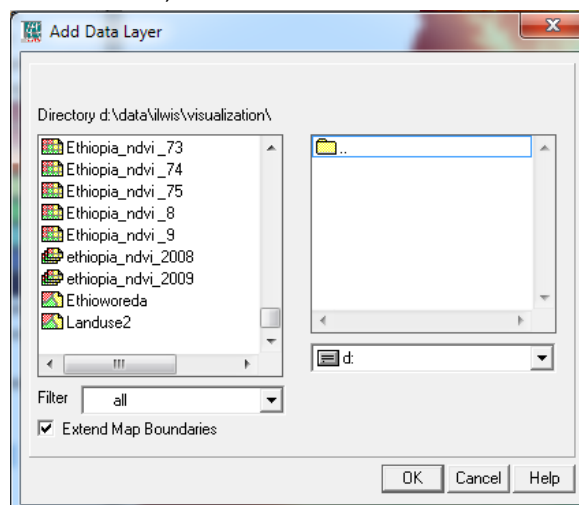

- The context menu of the empty area below the layer tree. This opens the same form as the menu option
- Drag and drop a map from the catalog to the map view.

POLYGON COVERAGE

The polygons of a polygon layer are made of areas and boundaries each with separate visual properties. In the Layer tree these are represented by different tools.

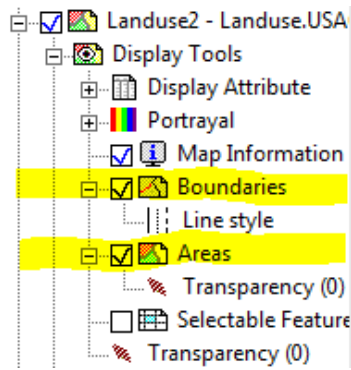

Each of tools can toggle the visibility of the element it controls. So one can view a polygon map with only boundaries or a polygon map without boundaries. Default both options are on.

The Boundary tool as a simple Line Style tool with which one can alter the properties of the boundary lines.

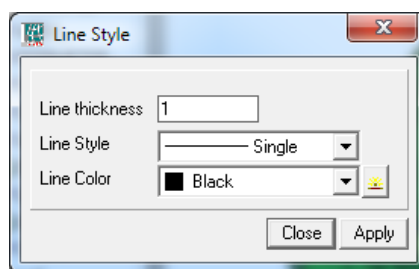

Note that line thickness has no real unit. It is not cm, nor points, nor pixels. It is a relative measure. '1' is the minimum thickness anything else is a multiplier on this.

The Areas tool has only the transparency that can be set (of the area, not the boundary). This works the same as the layer transparency discussed earlier.

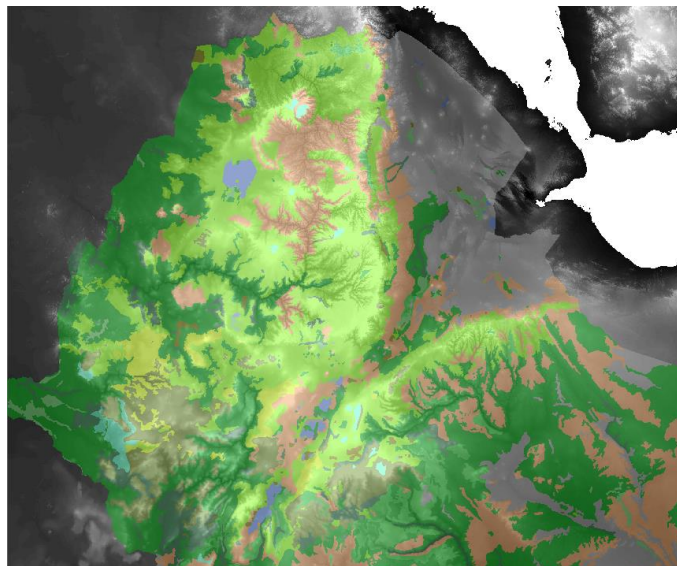

As an example; A composition of a landuse map with boundaries turned off and areas 50% transparent overlaid on a DTM (in gray).

SEGMENT MAP

A segment has basically only one property to change: the line style. The tool that changes this is similar to the boundaries tool of the Polygon layer but you cannot change the color with it. Colors are changed by the Portrayal tool as segments of a domain in contrast to boundaries.

POINT MAP

Point layers are more complex in their visual properties. All pointmap specific visualization properties are controlled by the Symbolization tool

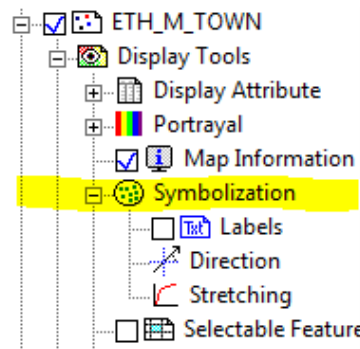

The tool consist actually of three (sub) tools.

1. General properties. Controls type of symbol and default size.
2. Direction/orientation of symbols. Attribute (value) based .
3. Size of symbols based on an value attributes.

First the general properties. The form that controls the general attributes is reached by double clicking on the symbolization tool(node).

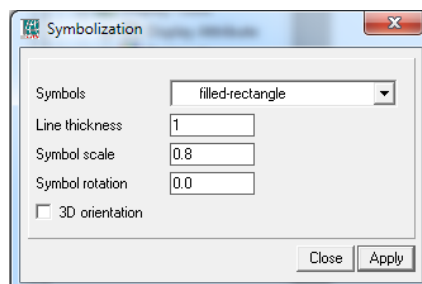

The combo box allows the user to select the type of symbol he wants to use for this points. There is a reasonable sets of symbols available and they can be extended (see also appendix ...).

The line thickness overrules the default line thickness set in the definition of the symbol(see also appendix...).

This can be useful in cases were one wants to emphasize (or the reverse) a certain type of symbol without needing to change the symbol.

The symbol scale overrules the default scale. As with line width, there is no real unit attached to the scale. There is a default scale and the rest is multipliers on this default scale. Note that that the scale (factor) decreases as more

points are in the layer to avoid clutter.

The rotation entry controls the rotation (in degrees) of the symbols. This is not the same as 'Direction' tool described below but applies to all symbols equally.

The last entry is only for 3D and rotate the symbol 90 degrees in the z direction.

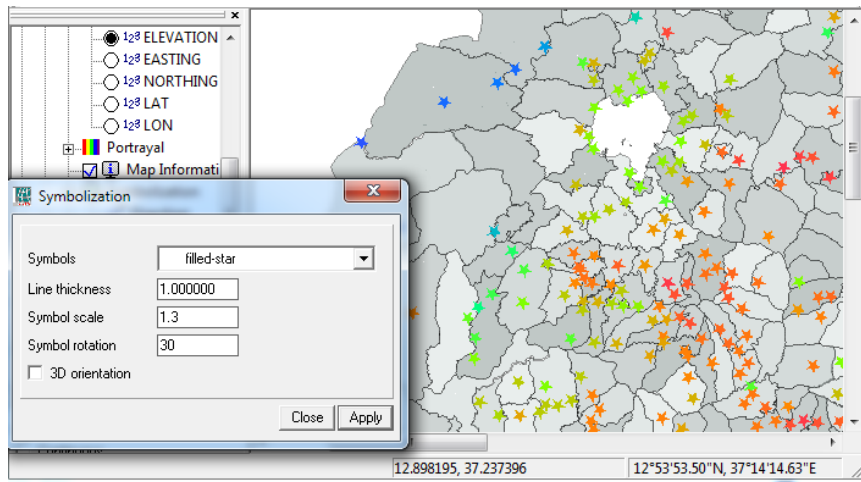

The figure above combines some of these properties.

The second tool controls the rotation of a symbol based on a value attribute.

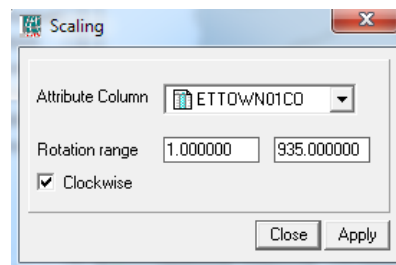

The combo box selects which value to use while the range specifies how the values are mapped on 0-360 degrees.

Below is an example of a wind field map (combined with the stretching tool described below)

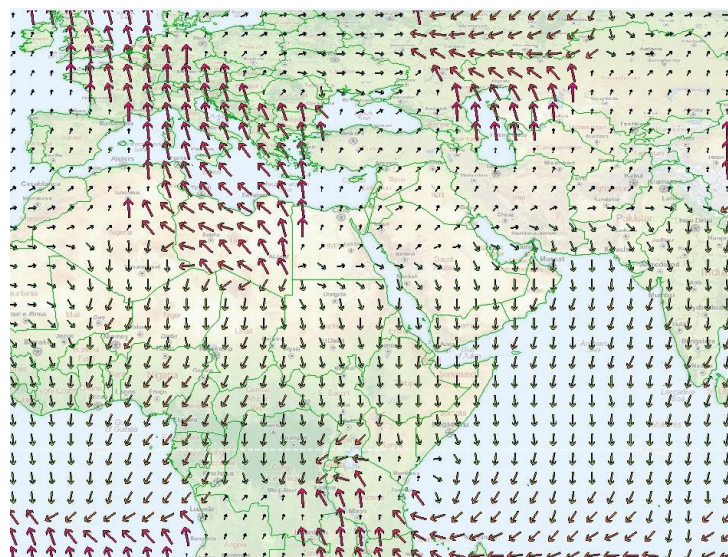

The last tool controls the stretching of symbol size in relation to a value attribute. It links the symbol scaling to the attribute and accordingly makes the symbol larger or smaller depending on the attribute.

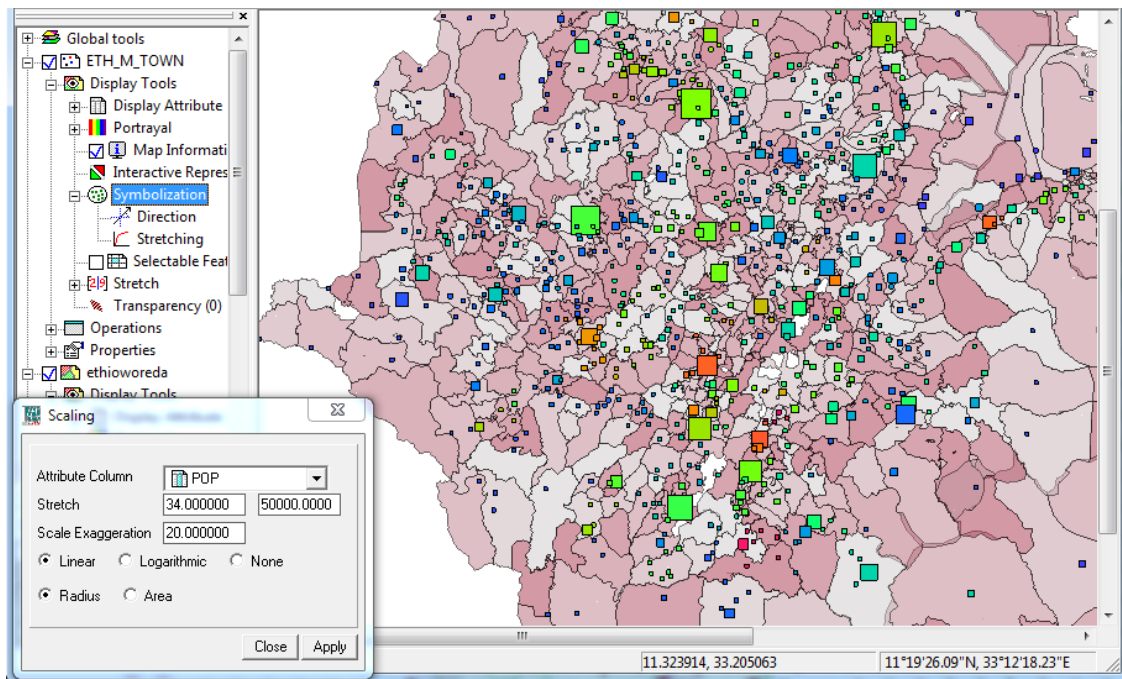

The combo box selects the (value) attribute used for the stretching. The second determines the stretching range. Sometimes a dataset is totally dominated by a few values making the scaling of the rest impossible to see. With the scaling one force the upper(or lower) limit of the scaling and stretch on that value. The example above is about the population size of cities in Ethiopia. In this country, the capital, Addis-Abeba , dominates, in size, the rest. So the stretching has been set considerable lower to illustrate the relative size of other cities. There two types of stretching. Linear and logarithmical. With linear stretching there is a 1:1 correspondence to the numerical value of the attribute and the size of the symbol. With logarithmic stretching this correspondence is based on a logarithmic scale.

SELECTIONS

Ilwis allows selections on features in tables and layers. One can enable feature selection by toggling the checkbox with the “Selectable features” tool.

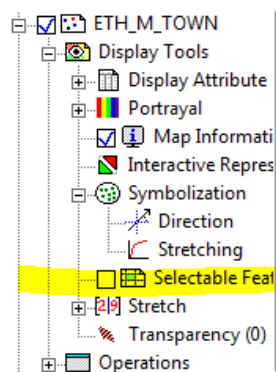

If enabled it allows the user to draw a selection rectangle on the map and all features in this selection will become selected. If an attribute table is associated with the spatial data set and the attribute table is open, simultaneously the corresponding records in the attribute table will be selected.

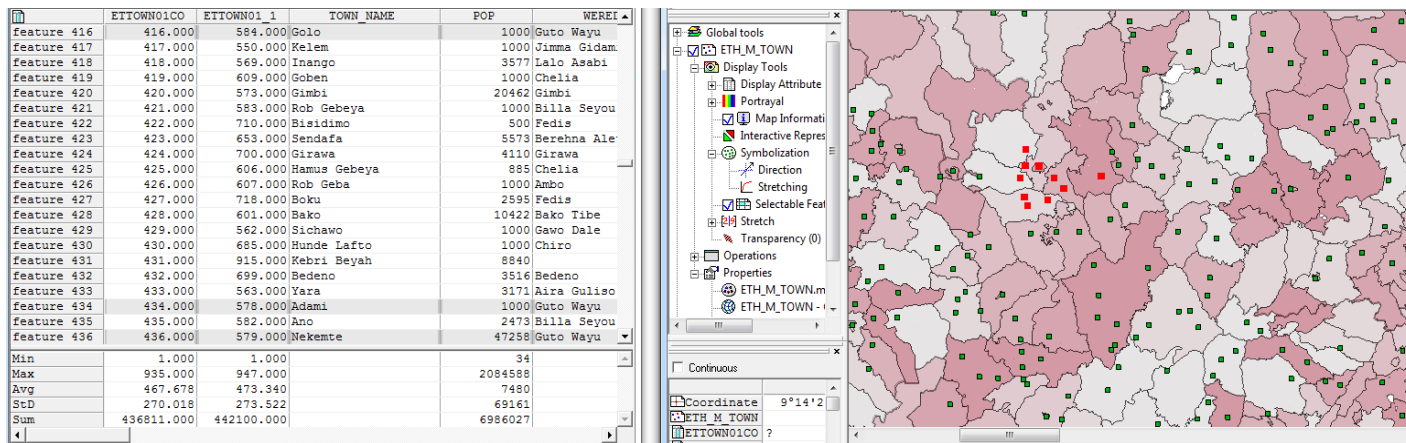

In this example a number of points close to the center of the layer are selected and the selected records show up in the attribute table (grayed records). Some selected records are outside the scroll area of the table. This selection process works both ways. If records are in the table the corresponding locations in the layer will be highlighted.

There is a special option that can be found under the edit menu. “Set selection by column”. This uses a **boolean** column to select features in a layer. By using this method one can formulate (Boolean) queries to create columns for sub selections. So for example if a Boolean column based on the expression “lim_pop=pop>5000” would be created and use this as selection column, only those records/features that have a true value in the Boolean column (so, those with pop > 5000) would be selected.

Related to this are two things

- First of all. In the map window, under the file menu, there is a new option “Save selection”. This enables the user to save a selection as a separate, independent spatial data set (sharing the attribute table if there is one).
- Second. In the table window there is in the view menu an option to “View selected records only”. This reduces the viewed records to only those records that are selected. The rest are invisible. Note that the column statistics are adapted to reflect this change.

LABELS

Polygon and point maps may have labels associated with them. The label value comes from either the value of the feature or from the associated attribute table. The label tool is not by default active and must be activated by the context menu of the display tools node. It will appear under the symbolization node for point layers or between the rest of the tools for polygon layers

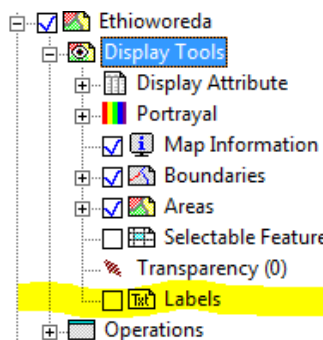

Enabling the tool will print labels for all the features. Double clicking it will open a configuration form in which you can set the font scale, font color or choose an alternative source for the label text from the attributes of the layer.

ANIMATIONS

With animations Ilwis displays consecutive spatial data sets in a MapList or ObjectCollection. This can be used to display for example spatial temporal data as animation. Ilwis can work in two modes with animations. First of all, the simple indexed based animations. In this mode the maps are displayed at a constant (user-defined) frame rate. This mode is always available. The second mode is based on time information and bases its frame rate at time intervals per second. For example, 1 day per second. This mode is only available when an attribute table with time information is attached to the maplist or object collection.

As far as Ilwis is concerned an animation is a normal layer in the Map view and all tools that logically can be expected can be used for animations as well (applied to all the elements of the animations)².

There are three ways to add/start an animation in the Map view.

- The context menu of an MapList or ObjectCollection in the Catalog
- As animation in the add layer form
- The tool bar button of an opened MapList or ObjectCollection

When opened a animation appears as a normal layer with two extra tools added to its normal set of tools

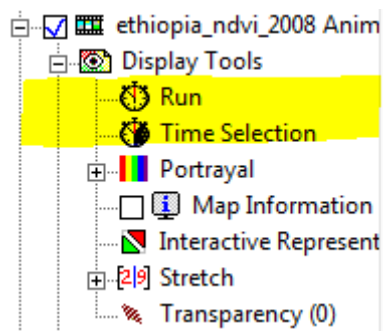

The 'Run' tool, which starts the animation and the 'Time selection tool'. There is a third tool 'Region of Interest' but this is by default not active. You can activate it through the context menu of the 'Display tools'.

ANIMATION MANAGEMENT

The most complicated of the animations tools is the Animation Management tool which you get if you double click the 'run' node.

² Note that animations do need a decent graphics board to work properly as they do consume a reasonable number of resources of the graphics board.

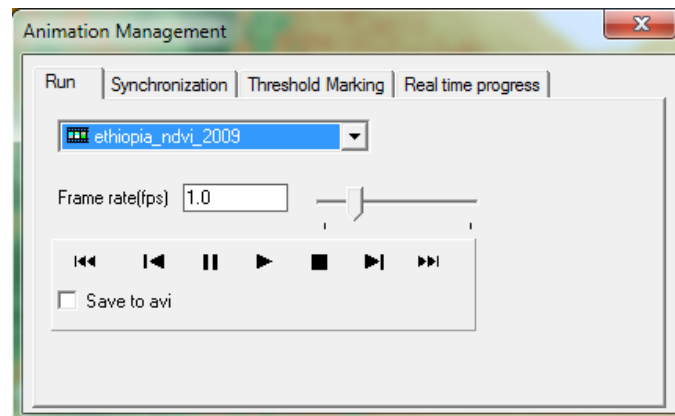

The form has four tabs which all control different aspects of an animation. The one most used is the first tab, the 'run'tab.

RUN

This tab has 4 properties it can control

- In the combo box you select which animation is controlled by the form. As you may have multiple animations and we don't want a multitude of forms when trying to set the properties of a form; this form can control them all. In most cases you only have one animation so it not useful then.
- Frame rate. Two controls, the (numerical) edit box and the slider. The frame rate controls how fast spatial data sets from the list are shown, frames per second (fps). The edit box has an unlimited range (e.g. you might go for 60 fps), the slider only 0-5 fps. Note that the fps is an estimation which is reasonable correct but it is a bit dependent on other activities on your computer and is not always guaranteed to have the exact value. Also, the first loop through an animation might have a lower fps in the case of bigger maps because some calculations are taking place in the background (only first loop).
- Flow control. The set of 7 buttons control how the animations runs. From right to left.
 - Go to the first frame
 - Go one frame back
 - Pause
 - Start animation from the current index
 - Stop, resets to the beginning
 - Go one frame forward
 - Go to the last frame
- Save to avi. When selected a edit box will appear and the animation will be saved to an avi (mp4 encoded) in the current working directory. The avi runs until stop is pressed. Note that this should be done **before** the animations is started else nothing happens.

SYNCHRONIZATION

The second tab controls synchronization between different animations. At times it may be useful to synchronize two or more animations for simultaneous inspection. Synchronization happens through a Master/Slave mechanism. The master is the list selected in the first tab. One of the MapLists/ObjectCollections is selected as master and other animations are "following" this one. If a frame changes in the master, the slaves check if they also should change frame. Normally Animations are independent and follow their own timers. In the synchronized mode they follow the timer of the master. The synchronization has two modes.

- Indexed based. The default mode. This simply synchronizes on indexes of the MapLists/ObjectCollections involved. The MapLists/ObjectCollections being synchronized need not to have the same number of entries. If they are not of the same size the master (who controls the pace) will use a fractional index over the indexes of the other map to select the map that will fit his index. So if you have one list of 36 and one of 12 maps and the one with 36 maps is the master; it will show one map from the second list for every three of the first.
- Time based. If the MapLists/ObjectCollections being synchronized have time columns and the time column is selected in the “real time progress” tab then the synchronization will happen based on time. Every second in real (user) time is mapped onto a certain time period. So for example every second(real time) , might be mapped onto 5 days (animation time). So if you have frames every 10 days, they show every 2 seconds (2 seconds fps). It is quite possible to have irregular interval this way.

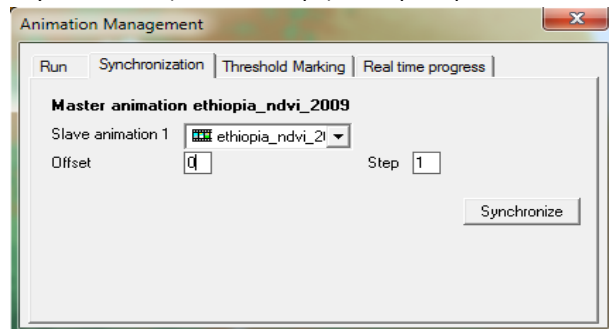

The offset determines where in the list one wants to start with the animation.

Note that synchronized animations need not to be in the same Map window. The animation management is aware of what is happening in other map windows.

THRESHOLD MARKING

Threshold is a simple interactive method of slicing. It is related to the range settings with transparency but with more flexibility and interactive representation. With threshold marking one marks values of a raster spatial data set exceeding (or the reverse) a certain value with a special color. During an animation it is sometimes difficult to spot when something ‘interesting’ is happening. The animation is dynamic and the ‘interesting’ event may already have passed before you really notice it. Threshold marking is a tool that might assist you in spotting these events more easily.

This is done in conjunction with an attribute value representing some aggregate value in the spatial data set. This means of course that you must have an attribute table associated with this tool to work properly.

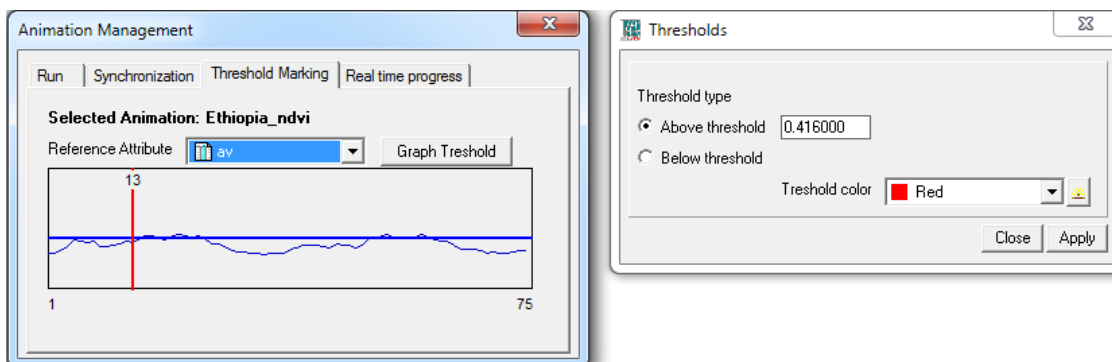

The role of the attribute is to be able to identify maps where something 'interesting' is happening. This attribute is represented in the graph. The marker (red) identifies the layer currently visible. If you click on the graph the marker will move to the index pointed out by the mouse.

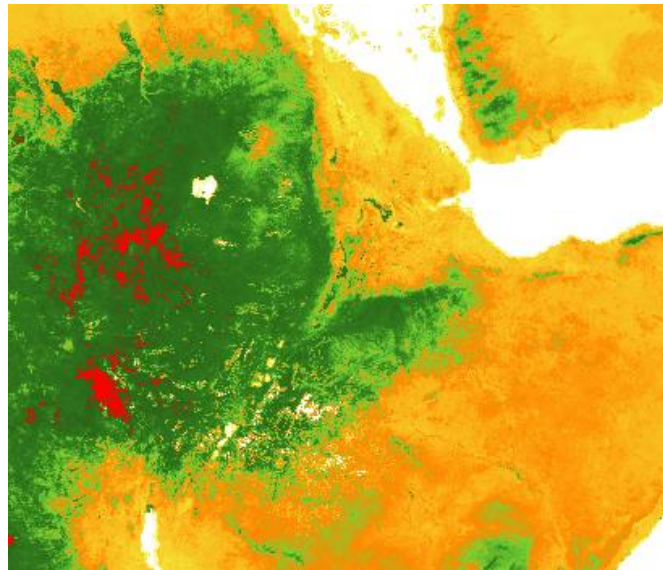

Above is an example where the threshold is set for 0.85 (NDVI value in this case) to spot when this value is exceeded.

REAL TIME PROGRESS

AREA OF INTEREST

Related to the animation is the Area of interest tool. It is a tool that is by default not visible but can be enabled by the context menu of the display tools node.

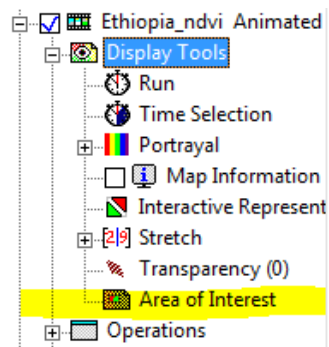

The purpose of the tool is to mark an area on the map for closer inspection and not be bothered by the clutter of the rest of the animation without losing track of the whole layer. The picture below gives you an idea of what it does.

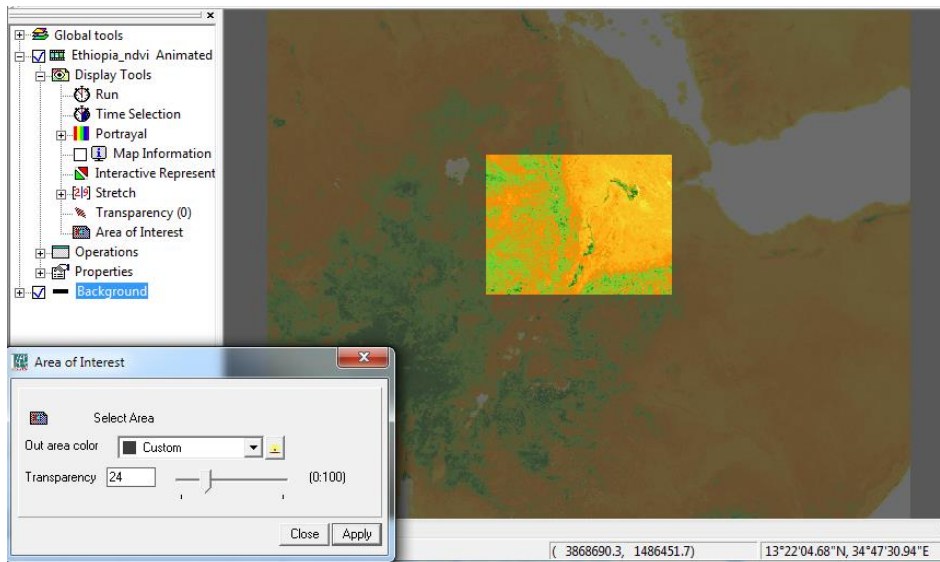

The options form can, as usual, be reached by double clicking on the tool itself. The area can be selected if you click on the 'Select area' button on the form. The other two options control the color of the outside area and its transparency.

TIME SELECTION

With time selection one can reduce the set of spatial data sets that are actually used in the animation.

- The large list allows the user to select which spatial data set should be included in the animation. The regular selection keys for block selecting and individual selection ('shift' and 'ctrl') do apply here.
- The two edit fields below allow you (for full selections) to specify a start position and a step size. The step size indicates how many maps are skipped after each frame.

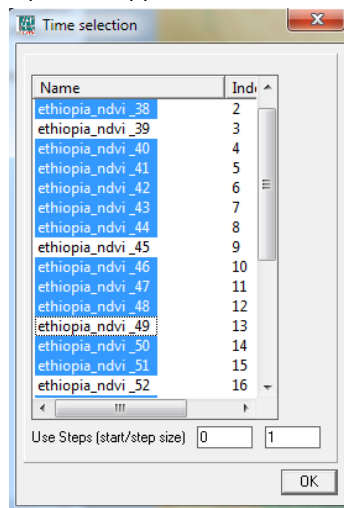

GLOBAL TOOLS

3D VISUALIZATIONS

Ilwis layers can be viewed in a 3D perspective. This mode can be toggled by the 3D tool under the global tools.

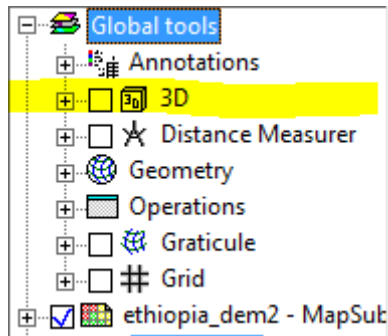

This doesn't mean that it automatically gains a z-coordinate (that has to be added separately, see 'Z Datasources') but it is now in such a mode that z-information can be used. Moving around the Map view and zooming works (as expected) differently than in the 2D mode.

Rotating around the view works by pressing the 'ctrl' button on your keyboard and pressing the left mouse button. By moving the mouse left/right/up/down the view rotates. Panning works by pressing the 'ctrl' button on your keyboard and pressing the right mouse button. Zooming works through the scroll wheel of the mouse.

There are a number of properties one can use and they are controlled by the '3D properties' tool. This is a tool (per layer) that is by default not visible. You can enable the tool by using the context menu of the 'Display Tools' node of the layer (see earlier description of the layer tree). If enabled, the layer gains an extra tool

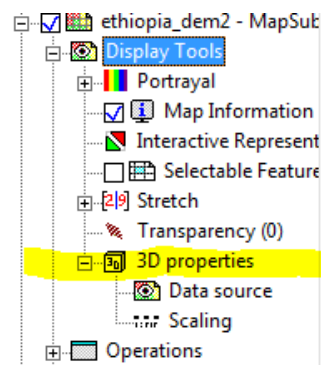

The tool has an extra sub tool for ('extrusions') for feature maps.

Z DATASOURCES

The default view of the 3D view is not very interesting. The maps remain flat. To make the 3D view interesting one needs to add a z-datasource. As usual a double click on the 'Data source' tool will open a form with the options.

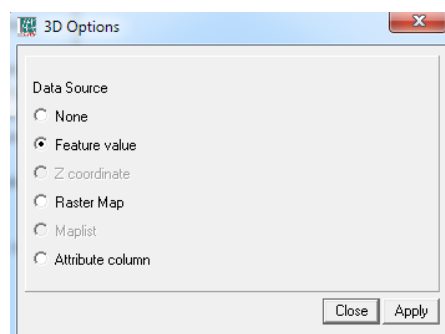

There are several options here (some are grayed out because they are not relevant for all types of layers).

1. 'None'. No z value used, never.
2. 'Feature value'. Used for z-value of feature maps. Not relevant in other cases.
3. 'Z coordinate'. Though it is not often used. Ilwis does understand real 3D coordinates and if they are present they can be used to display features in 3D.
4. 'Raster map'. Probably the most often used option. The value of a raster-map is used for the z-value. This raster-map may be the raster-map itself (e.g. in the case of a DTM) but may also be a totally different map.
5. 'Maplist'. Only relevant for 3D animations of Maplists. Similar to the previous option but then for a list of raster-maps.
6. 'Attribute column'. Any value column of an associated attribute table can provide a z-value for features/classes in the displayed.

Below is a simple DTM visualization

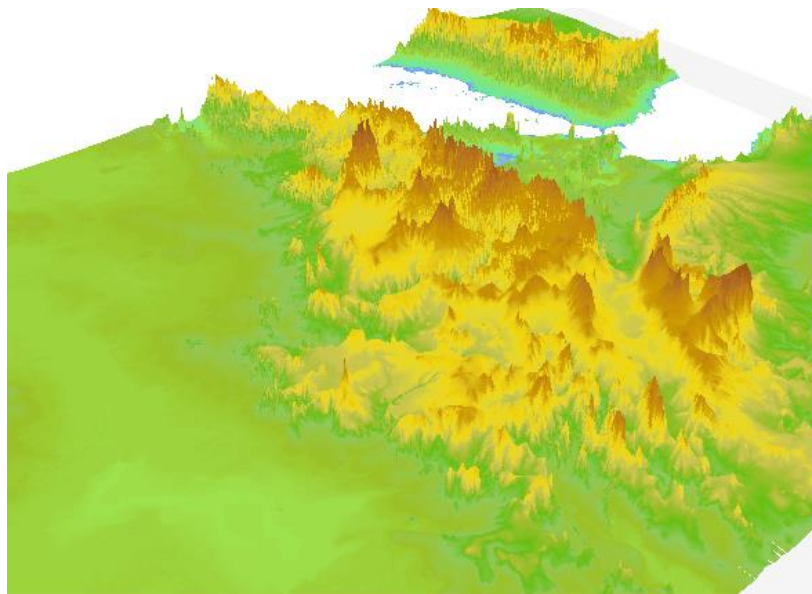

Any numerical value can be used for z-values.

Sometimes the scaling is a bit too exaggerated. In those case one can use the scaling tool.

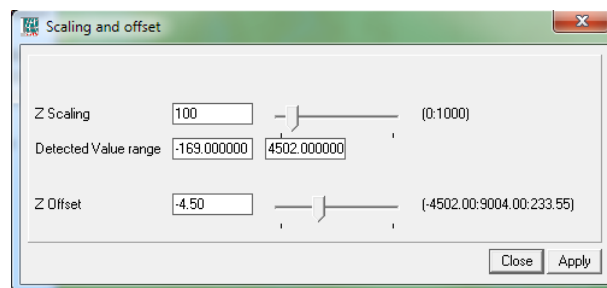

The Z scaling is default on 100 (%) of the calculated default scale of the z-value. It makes limited sense to attach real values to this z value as real values would in most cases be hardly detectable. On a scale of Ethiopia for example, say 1000 km, the height of its highest mountains (around 4 km) is negligible. So exaggeration is always needed.

Sometimes (particular in raster spatial data sets) there are odd values in maps. Often they are pseudo "Unknown" values, coming from an import. As such they are normal numbers and thus are included when calculating scaling for z-values but they have odd values and can totally corrupt z-scaling. To prevent this the

user can force the value range of the map with the “Detected value range” option. The 0-plane can be shifted around with the Z-offset.

FEATURE EXTRUSIONS

For feature spatial data sets there is an extra tool, the extrusion tool. Basically an extrusion draws a connection between the ground level and the feature in 3D space. It is a projection of the feature on the 2D ground level. It helps to orientate and understand what the position of a 3D feature is.

As usual by double clicking on the tool one gets the options

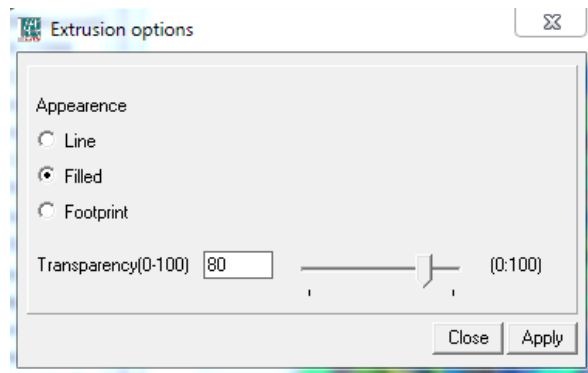

Extrusions are normally drawn as filled rectangle between two points of the feature and their projection on the ground level. This rectangle is partly transparent. With the line option the rectangle is only its frame (so no fill), with the footprint option only the projection on the ground level is drawn (so no frame, but the 3D feature remains).

The transparency option controls the transparency of the extrusion. Note that the color of the extrusion is controlled by the line color of the feature (boundary in polygons) and controlled by this tool.

Below is an example of extrusion using the population(2007) as z coordinate and the woredas (regions) of Ethiopia in 3D space overlayed over the OpenStreetMap tiles.

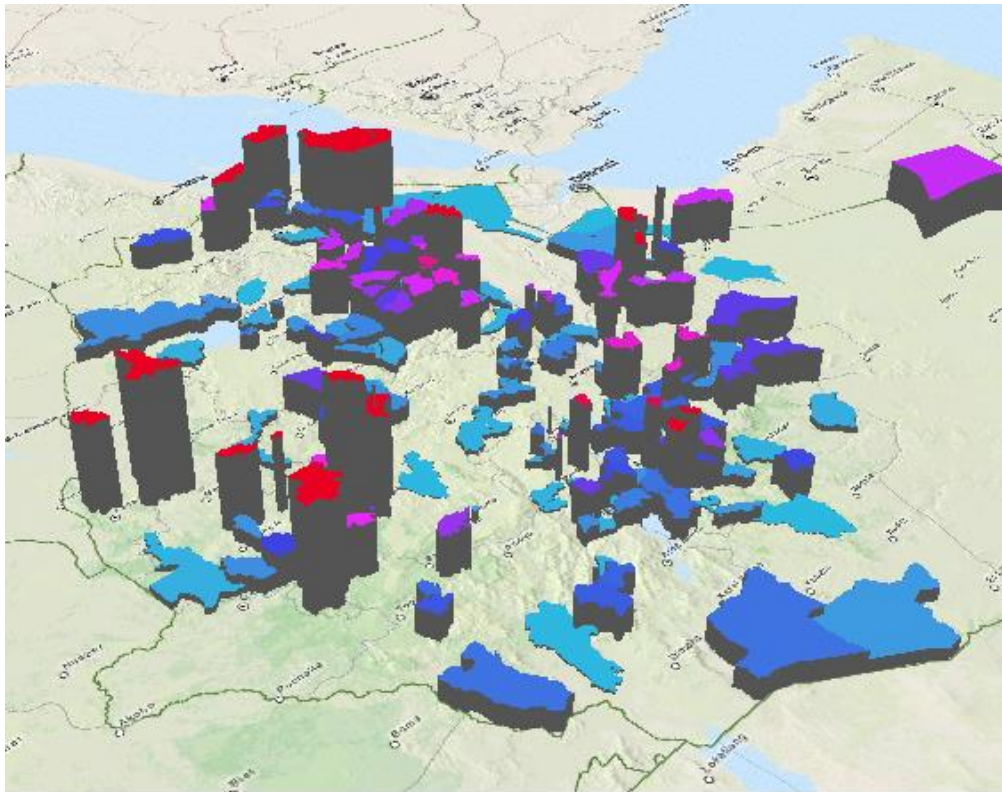

3D STACK

The 3D stack is another way of organizing your 3D layers in 3D space. It stacks all layers on top of each other with a fixed z space between them to enable simultaneous viewing of all the layers. To enable finding values in the spatial data sets and inspecting relations between the layers there is an option for a 3D cursor which intersects the layers with a line to show which locations (and thus values) correspond in the maps.

The 3D stack can be found under the “Global tools”.

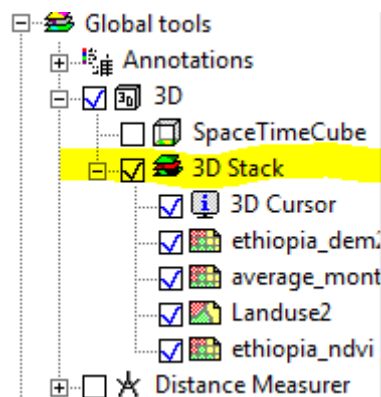

Below is an example of combining several layers of the Ethiopia data set and a 3D cursor intersecting all layers.

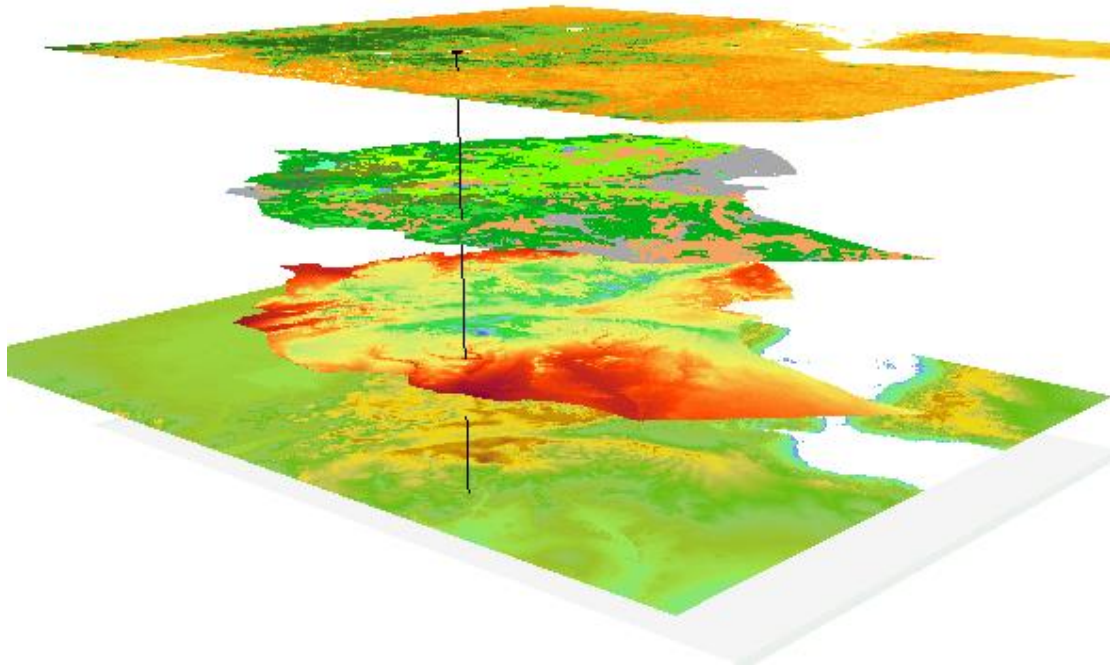

Double clicking on the 3D Stack node will show a small form with which you can change the distance between the layers and the offset at which the layers start. The latter can sometimes be useful as the stack grows higher and space on the screen is limited.

DISTANCE MEASURER

With the distance measurer one can measure distances between one or more points in the map view. There are basically two kinds of distances. The distance on map and the distance on the globe. The first one follows Cartesian rules with respect to distance calculations. It is straightforward and matches the 'real' distance on small scale maps reasonably well. The second one uses the ellipsoid to calculate the distance and is particularly on large scale maps better.

Distances can be measured by clicking on the map and then dragging the mouse (while holding the left mouse button pressed) to the desired location. When the mouse is released a form will appear with the distance in both 'map' case as the 'globe' case.

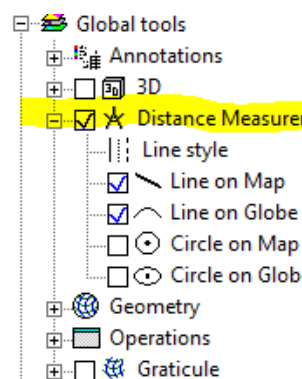

The difference between two distances is well illustrated on the two pictures below. The first one shows the difference between the map distance (the straight line) and the ellipsoidal distance (the curve). The second illustrates how an equidistance circle is distorted when projected on the globe.

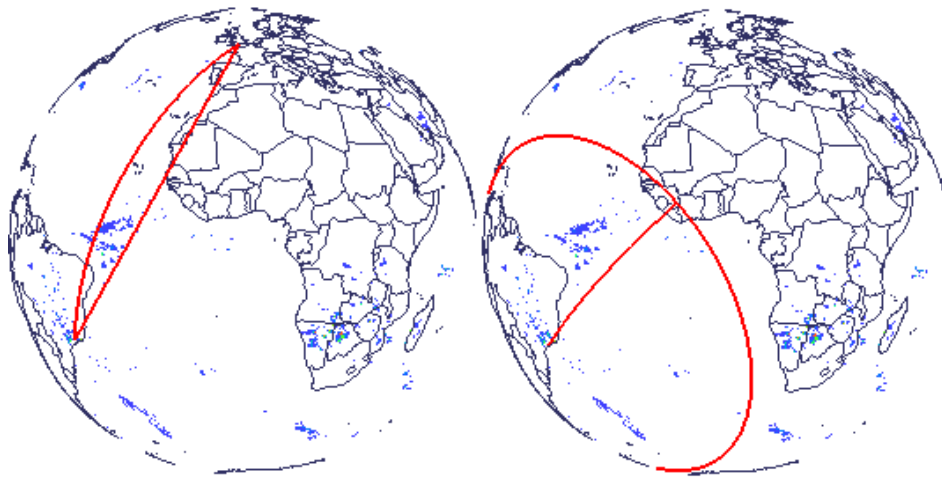

GRID/GRATICULE

Grid and graticule are two separate tools that place an equidistant lattice of lines on the map according to their underlying geometry. The grid is constructed according to the projected coordinate system (x,y), the graticule relies on the geographic coordinate system (latitude, longitude).

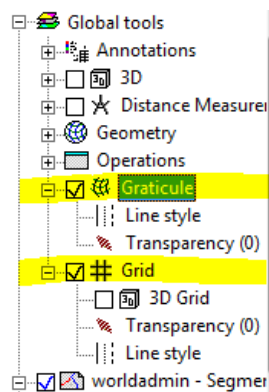

To illustrate the difference (lines thickness has been exaggerated to illustrate the point).

The segment map uses a geostationary projection. The red lines illustrate the graticule, the black lines the grid.

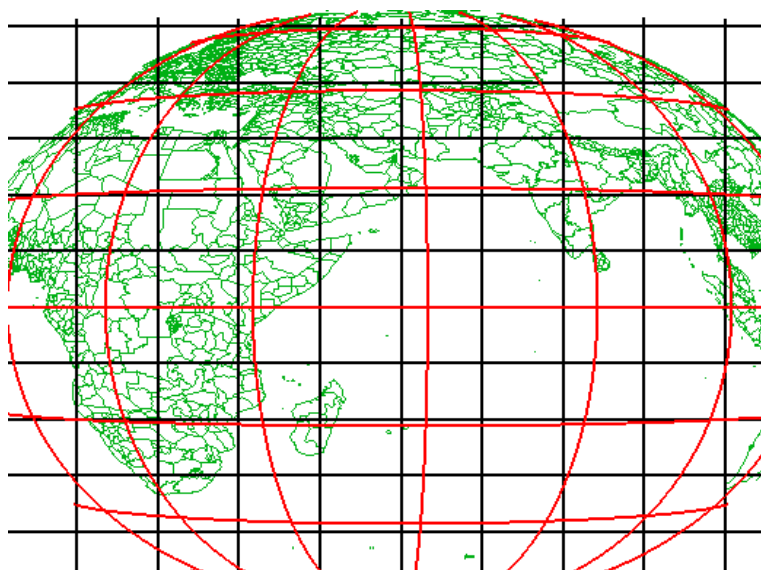

GRATICULE

Graticule is a simple tool. It is either on or off and. It has three sets of properties

- Line style. Similar to line style tools used elsewhere in ILWIS. It can be reached by double clicking on the line style tool
- Transparency. Similar to transparency tools used elsewhere in ILWIS. It can be reached by double clicking on the transparency tool. By default the graticule is partly transparent.
- The distance between the graticule lines (degrees). It can be reached by double clicking on the graticule tool itself.

GRID

The Grid tool is similar to graticule . There is one difference, the grid has an extra 'mode', the 3D grid.

The 3D grid (obviously in 3D render mode) render the grid also in the third dimension (usually it used with the 3D stack).

When double clicking the properties of the 3D grid open

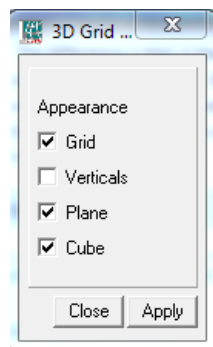

- The grid option is most like the normal(2D) grid. It just extends the lines with an extra set of vertical lines
- The second options switched of the verticals, so only parallel planes of grids exist
- The third options adds a fill color to the grid planes.
- The last option adds a wire frame cube/box around the map

Below are some samples of how it looks.

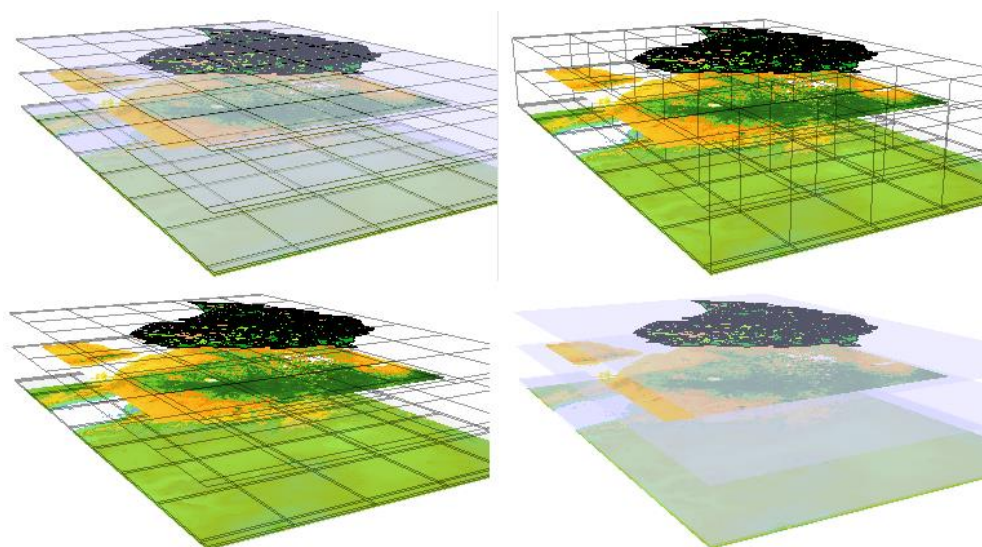

COLLECTION LAYER

There is a special type of layer that is called the collection layer. It displays the content of an Object collection as a single layer. The collection layer has as restriction that all spatial data sets in the collection must have the same domain and the same type.

What is the purpose of this utility? Look at the example below. It is a collection of 12 rastermaps (in total 24000x18000 rows/cols). On the left they are displayed as individual maps, on the right as collection layer

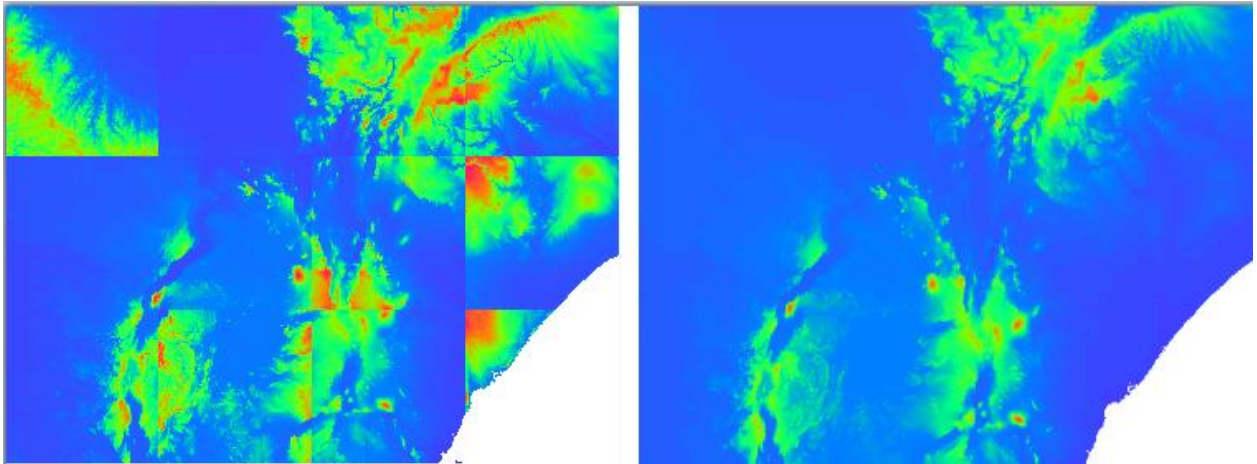

The difference is that in the first case Ilwis considers all maps to be separate and stretches ranges are calculated independently. On the right they are considered as one layer and the calculations are made for the whole. As far as Ilwis is considered the collection layer is a regular layer.

Of course the result above could also have been created by the operation GlueMap but this, on the fly mosaicking, is much more convenient.

CROSS SECTION

The cross section tool lets the user inspect the relation of a certain coordinate in the layer and the corresponding values in one or more maplists. Basically one clicks on the map and window pops up with a graph that shows the values in one or more maplists that have been selected.

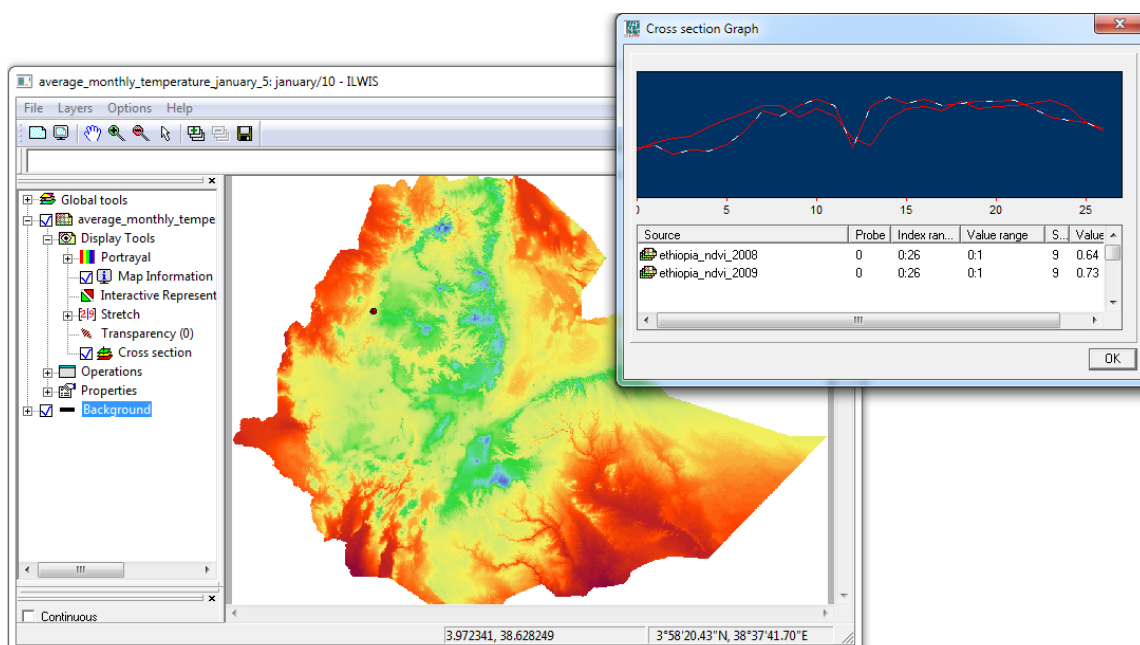

The tool is not by default active and can be enabled by the context menu of the 'Display tools' node.

Clicking on the graph updates the information in the table below the graph. It will show relevant information about the map index selected. It is possible to add multiple probes on the spatial data set by pressing 'ctrl' when clicking. The graphs will be added to cross section graph but too many probes makes it a bit confusing. Right clicking on the graph will show the option to save the graph(s) as table

PROFILE

With the profile tool one can draw a line on the layer(s) that shows the value(s) of the layer in the graph window belonging to the tool. The line can have multiple segments if 'Ctrl' is pressed during drawing. At every mouse press a new direction can be chosen. Double clicking will end the drawing.

It is possible to add other spatial data set to the profile to check relations between profiles. Double clicking on the tool will open a simple form to add spatial data set to the profile. Possible types are value maps and class maps. In the example below, the colorful band is a profile of a class map.

Clicking on the graph will show the value of that point of the graph in the table below the graph and will show a marker in the Map view indicating where that position is.

As the default black, one pixel wide line may not always be practical (e.g. on dark grey maps) it is possible to change the line style using the often used line style tool.

The profile tool works with animations (you will see a moving graph then).

The profile tool is default not visible and only available if you switch it on via the context menu of the display tools node.

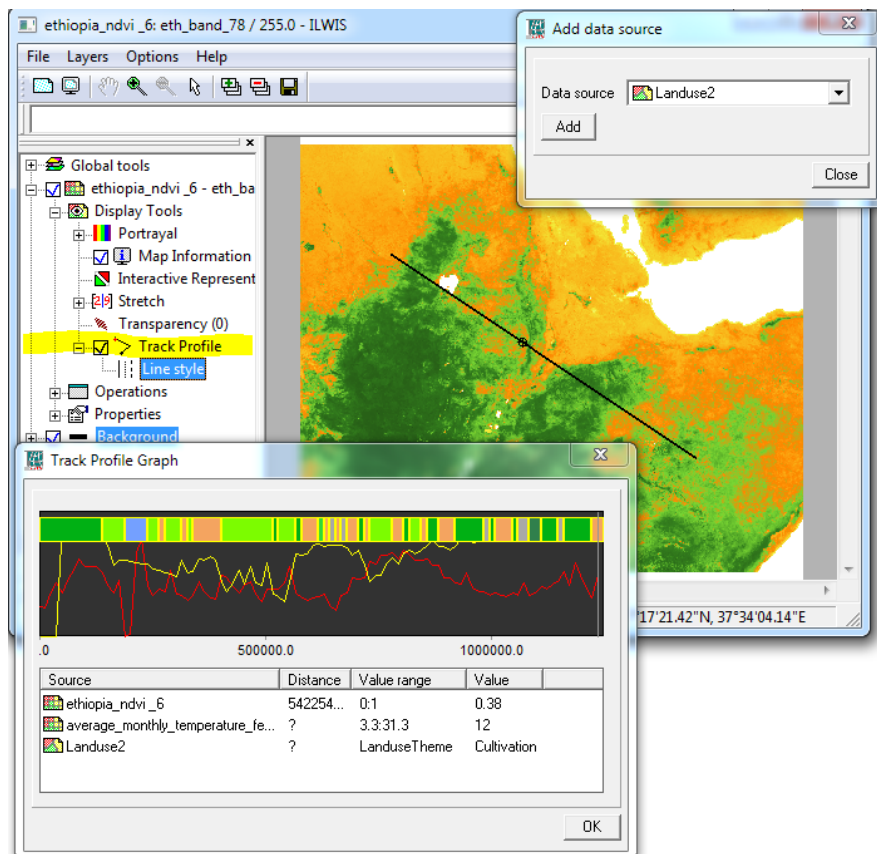

Right clicking on the graph will show the option to save the graph(s) as table

COLOR COMPOSITE

A color composite is created by combining 3 raster images (bands/maps). One band is displayed in shades of red, one in shades of green and one in shades of blue. Color composites are made from map lists

There are three ways to open a maplist as a color composite.

- The context menu of a MapList in the Catalog
- As color composite in the add layer form
- The tool bar button of an opened MapList .

By default the first three layers in reverse order will be chosen. If opened the Layer tree will look like

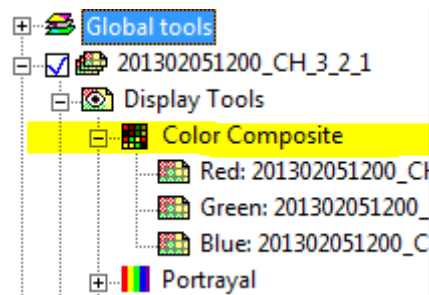

Double clicking on the “Color composite” node will open a form with which one can alter the order of the data sets used for the color composite.

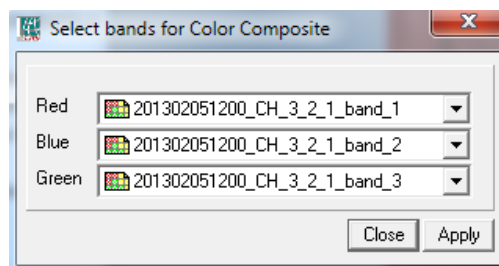

The stretch values of the individual bands can be changed by double clicking on individual bands below the color composite node.

HOVMÖLLER DIAGRAM

A hovmöller diagram is a sort of combination between the cross section tool and the profile tool. It shows the change of the values on a line on the map (like the profile) but this time it combines it with a whole maplist instead of a single spatial data set. The result is a 2D plane that shows the variations of values over (usually) time along the line

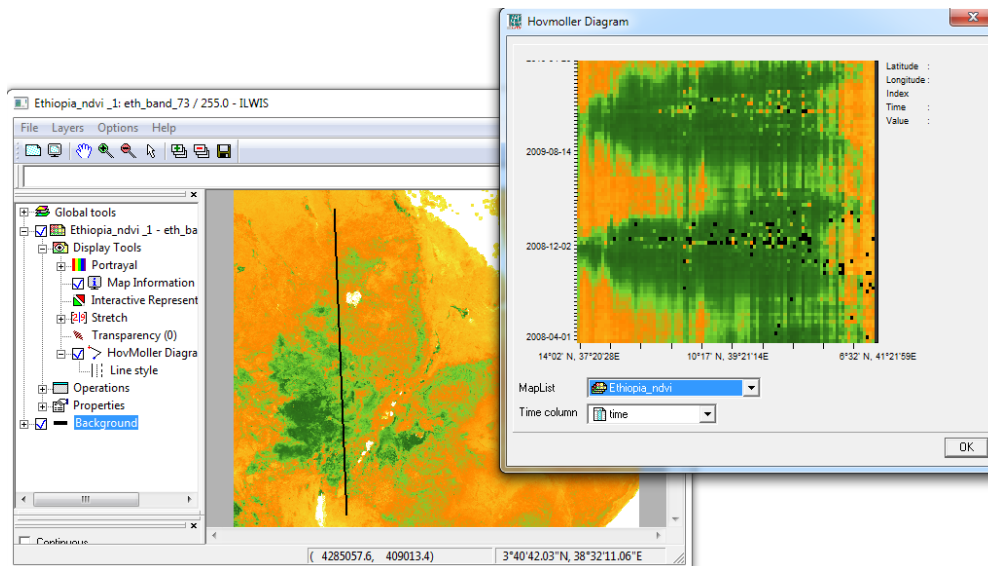

The idea is to spot patterns in the variations of values more easily (particularly wave like events). Though hovemöller diagrams are usually used in meteorological context they can also be used in other contexts. The example above is about a NDVI maplist of 2008-2009.

By clicking on the diagram one get detailed information (right-top) about that place.

HISTOGRAM

The histogram option is available for raster maps with domain value. It docks a small histogram graph on top of the window. One can have multiple histograms (one for each appropriate layer).

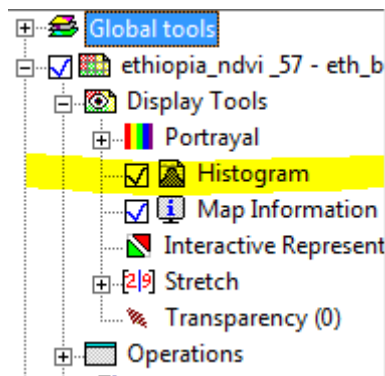

The use of this tool is that one can click on the graph and all the pixels that are (default) within 1% of the width of the value range of the selected value will be highlighted in the layer. If the mouse button is pressed and moved the selection will follow this in the layer.

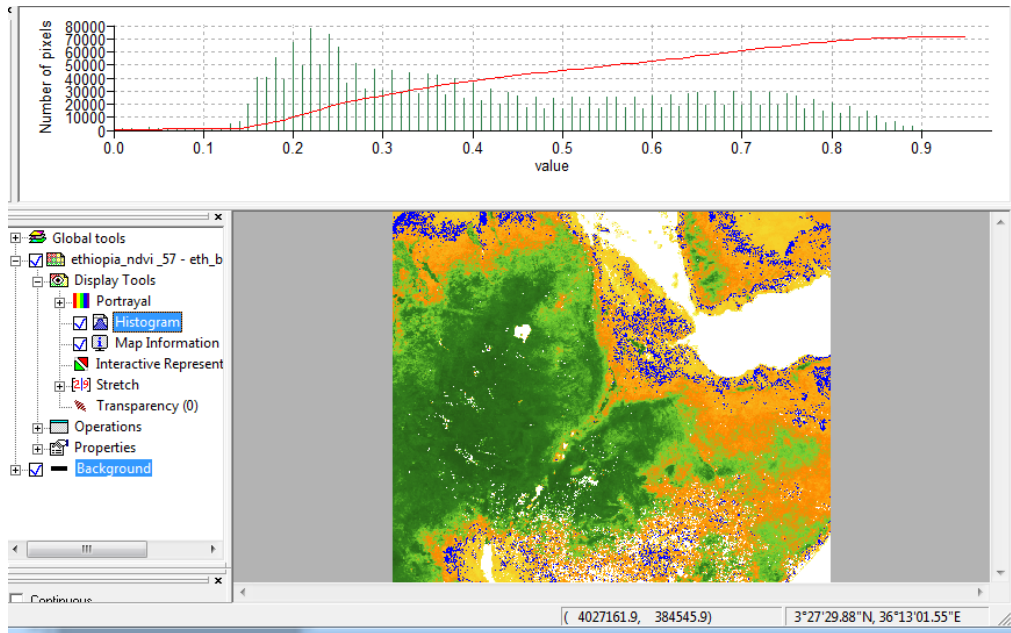

In the example the blue section represent a 1% interval around 0.18 (both sides).

By double clicking on the tool one gets a form to change the color and/or the spread.

INTERACTIVE REPRESENTATION

The interactive representation is probably the most complicated 'slicing' tool we have in Ilwis. It lets the user interactively create a representation where the boundaries, boundary colors and the change in the color are in total control of the user. In a sense it is similar to the representation editor itself but this editor is interactive and allows very sharp boundary edges (color wise) that are hard(impossible sometimes) to reach through the regular representation editor.

The editor only works on spatial data sets with representation gradual.

Double clicking the tool opens the first options form. By default this slices the map in two areas with shades of green. The number of areas can be changed by the combo box below the simple representation. For '4' it would look like

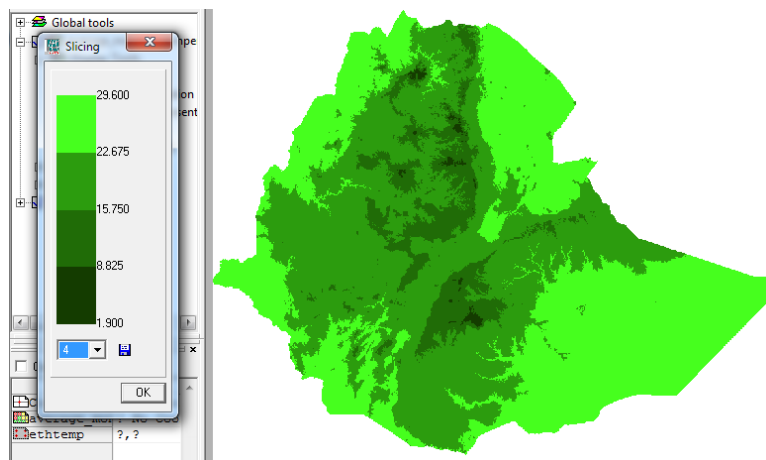

Nice, but a bit green and the ranges might not be to your liking.

One of the ways to change the ranges is by clicking close to a boundary. A redline will appear and as long as the mouse button is pressed one can drag the line around and the boundary is changed. At the same time the layer

will adapt to reflect this change. In this way one can create a view that gives a rough idea of the range boundaries one would need. Still the color is not changed and the boundaries are fairly rough. Double clicking on an area of the diagram will open the options form for that area

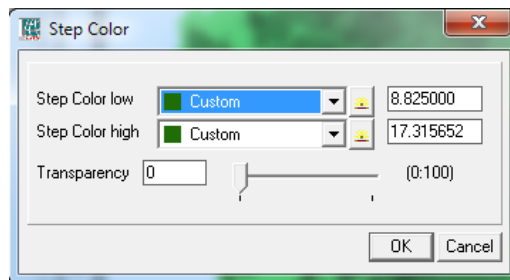

With this form one can change all the details:

- Low and high color of the area. The color will have a gradual change through these color
- Low and high value of the boundaries. For a precise definition of the boundaries
- Transparency of that area.

An example of changes in one area of diagram

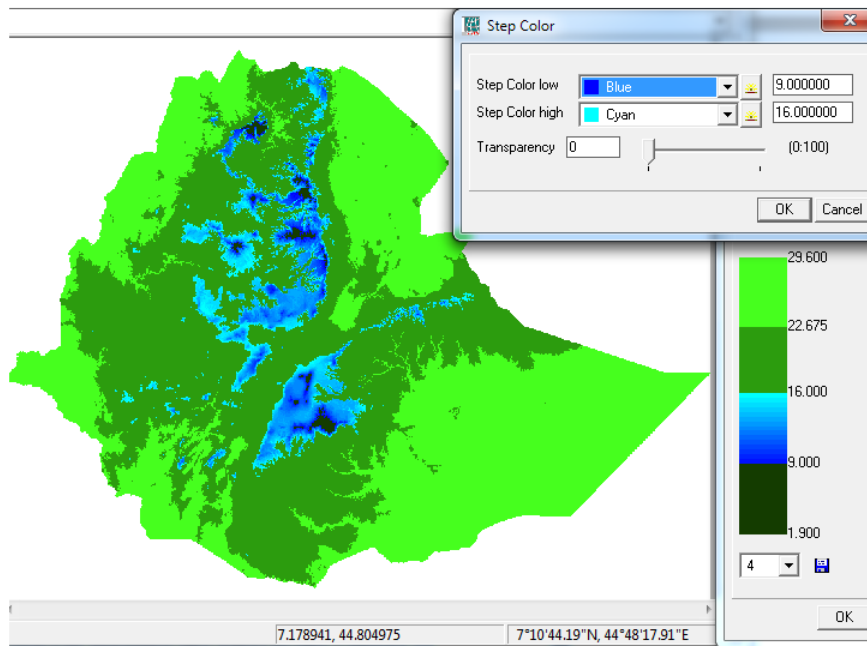

In this way one can create interactively a custom representation that exactly does what you want. The representation can be save by clicking on the small 'floppy' icon beside the combo box.

ANNOTATIONS

There are two types of annotation tools. Per layer and at global level. At the moment, at layer level only the legend can be added and at global level a border and scale bar can be added. The layer annotation is not active by default and has to be activated through the context menu of the 'Display tools'.

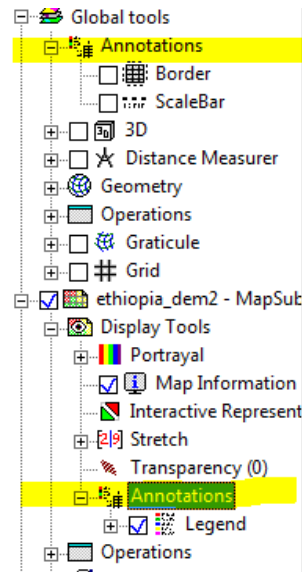

ANNOTATION LEGEND

The legend displays a legend in the map view (not to be confused with the legend in the layer tree). For value spatial data sets it displays a continuous range of numbers (from the range of values in the spatial data set), for class maps it displays the set of classes in the spatial data set. Below are two examples.

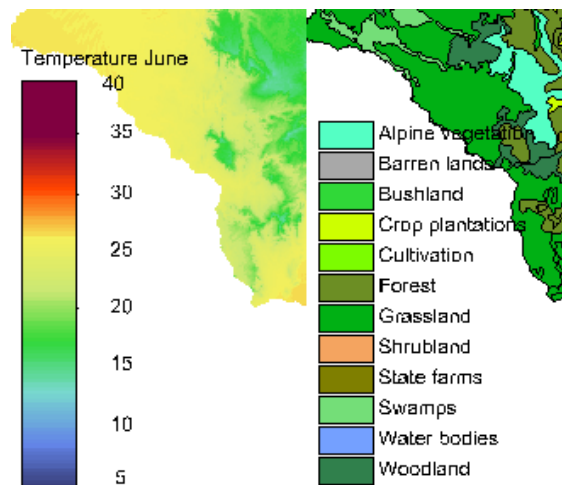

The position can be freely changed (double click size & position tool).

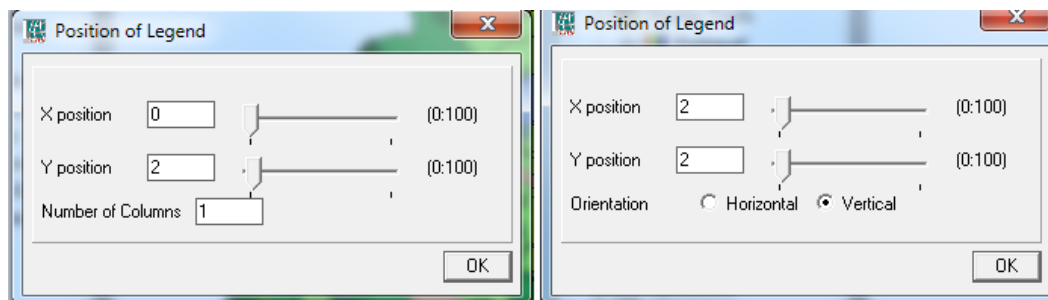

The X,Y position can be changed by shifting the sliders. Left form is for spatial data sets with domain class, right one is for spatial data set with domain value. The difference is that for value legends the orientation of the bar (and texts) maybe vertical or horizontal while the class legends may have one or more columns.

average monthly temperature march 8

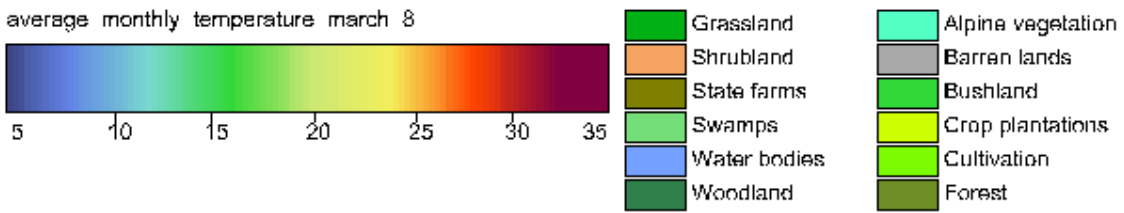

- Grassland
- Alpine vegetation
- Shrubland
- Barren lands
- State farms
- Bushland
- Swamps
- Crop plantations
- Water bodies
- Cultivation
- Woodland
- Forest

The second (sub) tool is the appearance tool. It is quite different for both tools. For value maps one can adapt the scaling of the legend (font and overall size), add a box around it and adapt the range and step size used by the legend.

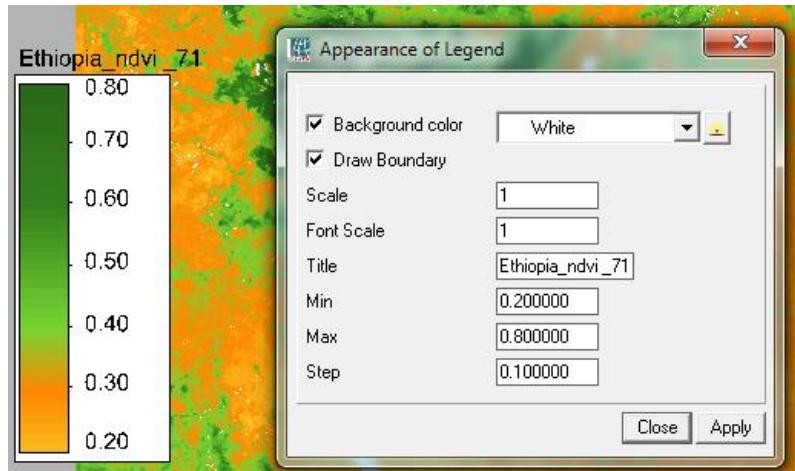

SCALE BAR

The scalebar object draws a simple scale bar on the map view as indicator of the scale of the map. The tool is located under the annotations of the global tools

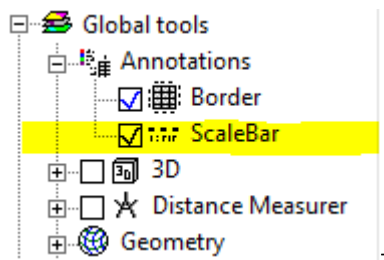

Though the scalebar works for both projected and geographic coordinate system it obviously makes more sense for projected systems. Double clicking the tool opens the configuration form

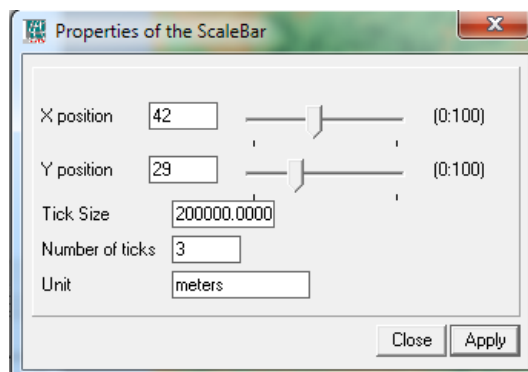

The X,Y positioners work similar to the ones from the legend. The ticksize determines the distance between the ticks and the number of ticks, the total number of ticks (+1, for the 0 value). The unit is an optional text to describe the units used.

SPACE TIME CUBE

ILWIS now has the ability to display spatiotemporal data in the Space Time Cube. This is a cube with on its base a representation of geography (along the x- and y- axis), while the cube's height represents time (t-axis). The cube can contain features such as Space Time Paths that represent the spatiotemporal tracks of moving objects, or Stations that represent the spatiotemporal tracks of static objects.

To construct the spatiotemporal track of an object, point-data with a temporal attribute is used, whereby the points represent the subsequent locations of an object or event, and the temporal attribute denotes the moment in time that the object was at or passed by the point's location or each event took place. If the location of the object changes in time, the track is called a Space Time Path, but if it remains unchanged, the track is called a Station.

Alternatively, a Station can also be constructed from point-data whereby each point represents the location of the static object, and both the start and end times are provided in the same record.

To plot a Space Time Cube in the ILWIS Map Window, a tool called "Space Time Cube" is made available under the "3D" tool.

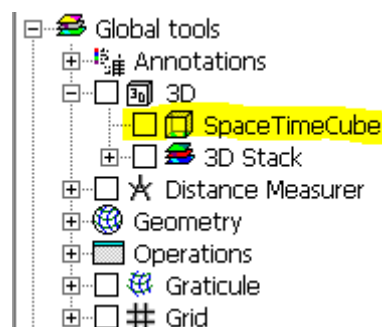

The Space Time Cube tool makes a 3D plot of spatiotemporal point-data in the 3D view of the ILWIS Map Window, using the temporal attribute for the 3rd dimension. In the case of a "space time path", each pair of subsequent 3D locations of an object is interconnected with a cylinder. All cylinders together form the object's "space time path", or, if the object's location hasn't changed during its lifetime, "station".

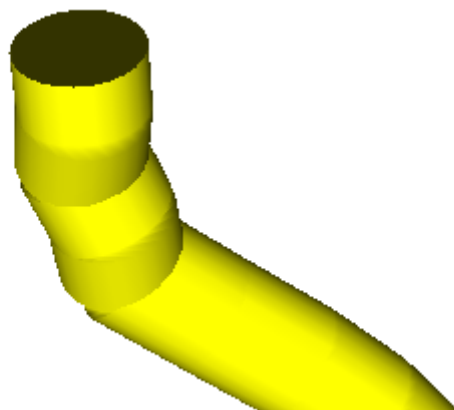

In the case of point-data whereby each point represents a "station", a vertical cylinder is positioned at the station's XY location, and the start and end of the cylinder correspond to the start and end times of the station.

A cylinder is used instead of a thin line, because light/shadow effects that assist in the perception of 3D depth on a 2D surface (monitor / paper), can only be applied on volumes. Furthermore, the cylinder's thickness can be varied to incorporate simultaneous display of an additional attribute.

When the Space Time Cube tool is switched on, it plots a cube that surrounds the extents of all layers that are available in the Map Window at that time. The names of the axes (X, Y, T) and their boundaries are also shown. The vertical dimension of the cube will be mapped to the minimum and maximum of all temporal attributes that are used in the Space Time Paths or Stations.

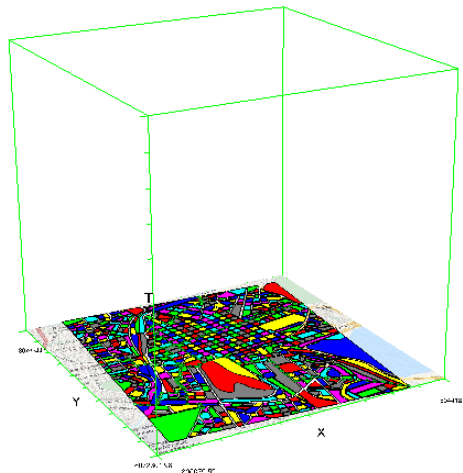

The mouse can be used to inspect attribute values of the objects at the mouse-pointer, but it can also be used to rotate, move, and zoom the cube. The floor of the cube can have several layers to be used as a 2D reference map, and the so-called "footprints" of the Space Time Paths (the 2D projection of their tracks). The 2D map can be moved up and down through time, for seeing when the path of an object is at a certain location.

PLOTTING SPACE TIME PATHS

To plot Space Time Paths or Stations, at least one "Point Map" with an attribute of domain "time" must be one of the layers of the Map Window. Double-click the "Space Time Cube" tool in the layer manager. This will pop-up the "Select Layer Options" form, which has one row for each layer that has a temporal attribute, and is used to select the desired options for each layer.

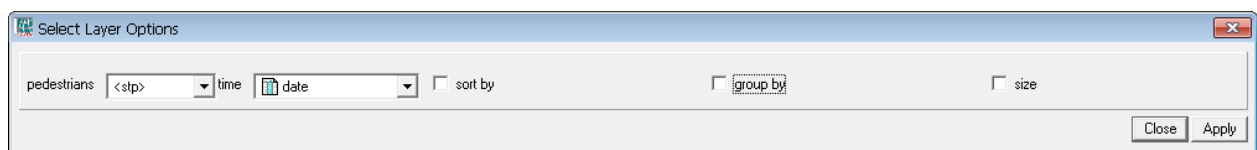

The left of each row shows the layer's name. Next to that, the desired plot-option can be selected, which can be one of:

- <regular>, plot the Point Map as a 2D layer, do not make use of the temporal attribute
- <stp>, use the Point Map data to plot space time paths (or stations if the objects are not moving). At least one attribute of domain "time" is required in the attribute table. When multiple temporal attributes are available, one can select the desired attribute from the list.
- <stations>, use the Point Map data to plot stations, when the start and end time are available among the attributes, or, when only an event-time is available, using 1% of the cube's height as the height of the station

In the option <stp>, a Point Map is expected to have its point-data (the spatiotemporal samples of the object) ordered in sequence (ordered by time). If this is not the case, they will not form a correct track when interconnected in their default order. To solve this, an attribute that denotes the correct sequence must be provided, to be used for sorting the samples ("sort by" option). Sort by the existing time attribute is also an option if the Point Map corresponds to a single moving object.

A Point Map used with the <stp> option can contain multiple Space Time Paths. The default assumption is that all points / samples of a Point Map belong to only one moving object, and will therefore be interconnected to form a single Space Time Path. To change this, an attribute must be provided that identifies which moving object corresponds to each sample, to be used for grouping the samples ("group by" option). The group-by attribute will allow the tool to determine where a path must be closed in order to start a new path, and prevent connecting the last sample of an object to the first sample of the next object.

When using both "sort by" and "group by", first "sort by" is applied, and then "group by".

For both <stp> and <stations> optionally an attribute can be used to vary the size of the cylinder. Low values will make that part of the cylinder thin, and high values will make it thick. The default is to stretch the radius of the cylinder linearly. For more fine-tuning, the "Scaling" tool that is available under the Display Tools of the layer can be used.

DISPLAY OPTIONS

If a Point Map has attributes that can be used to influence the color of the Space Time Path at each moment, this can also be selected, by first choosing it as a Display Attribute under the Display Tools, and then choosing the color ramp under Portrayal.

One can drag the vertical scrollbar on the left of the Map Window to move the 2D map through time in the cube, in order to see where and when a track meets a location.

Under the Space Time Cube tool, a tool called Elements is available. With this, one can switch on/off, recolor and restyle the cube's elements (Cube frame, Tic Marks, bounding coordinates and labels). The checkbox before each item can be turned on/off, and the item can also be double-clicked.

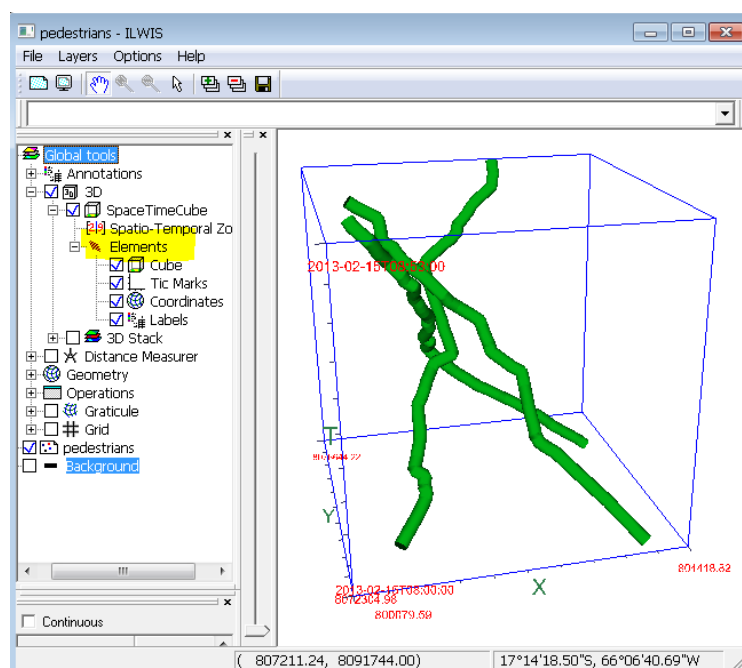

Under the Space Time Cube tool, the Time Zoom tool can be used to reduce the space and time that is encapsulated by the cube, therewith zooming-in in space and time, allowing for better focus on specific areas and time periods.

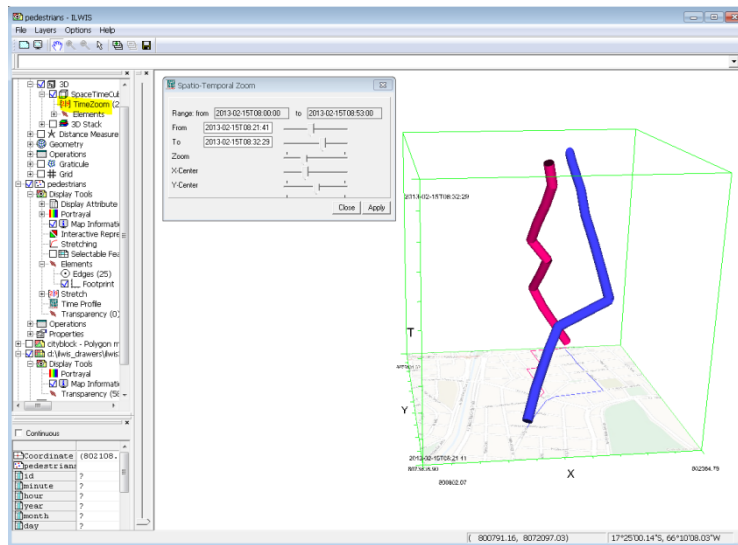

When a Point Map is used to plot a Space Time Path or Stations, extra tools are added to its Display Tools. The Elements tool can be used to switch on/off the footprint of the Space Time Path, and also to control the number of edges that are used to compose the cylinders of this layer. The higher the number, the better the cylinders look like, but there might be reasons why it is preferred to use a lower number, like computer graphics performance for high volume datasets, or cluttering and visual artifacts. If the number is reduced to 1, single lines are used to plot the tracks, whereby light-effects cannot be used. When using a layer for the first time, an auto-estimate is made of the optimal number of edges regarding computer graphics performance. This estimate depends on the number of points in the dataset.

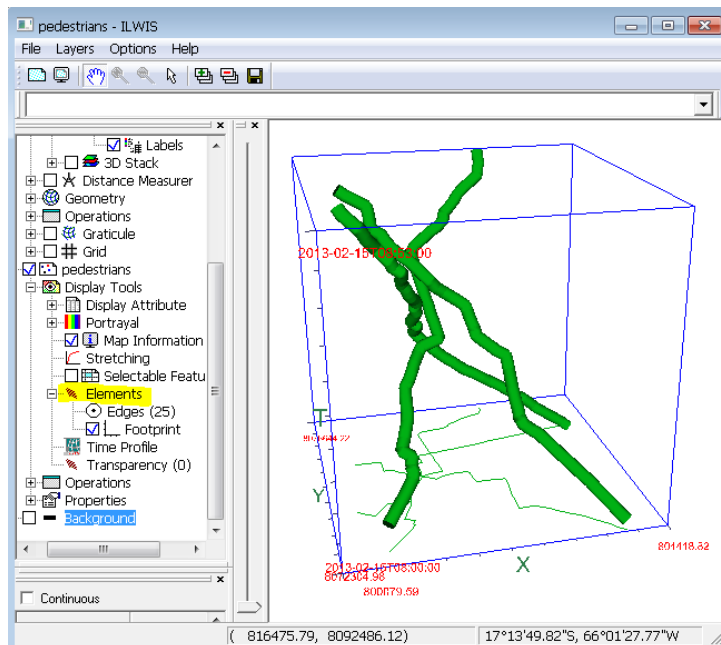

TIME PROFILE

The Time Profile tool opens an interactive graph window, where the X-axis has the projection of the tracks onto a segment (e.g. a street or path to be followed) and the Y-axis has the corresponding time. A segment map with the digitized street or path is required to use this tool.

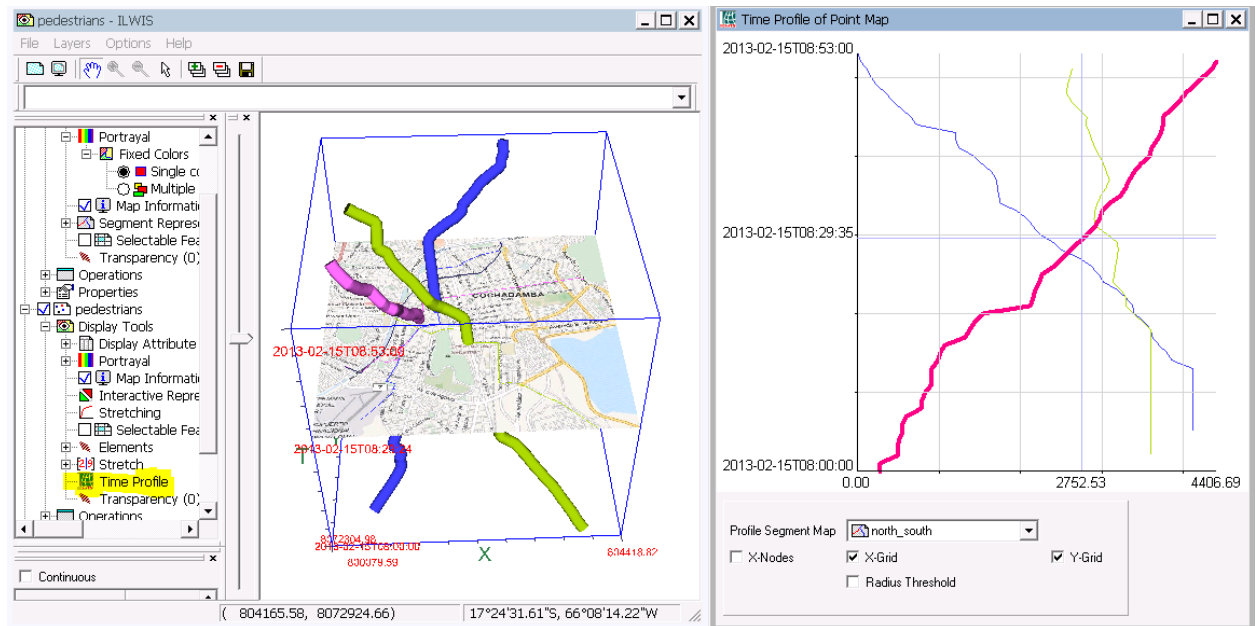

The Parallel Coordinate Plot tool is initially not visible under the Display Tools. Right-click on Display Tools, and enable it in the menu that appears. A window with an interactive Parallel Coordinate Plot will be opened. The available attributes can be turned on/off and re-ordered for proper analysis.

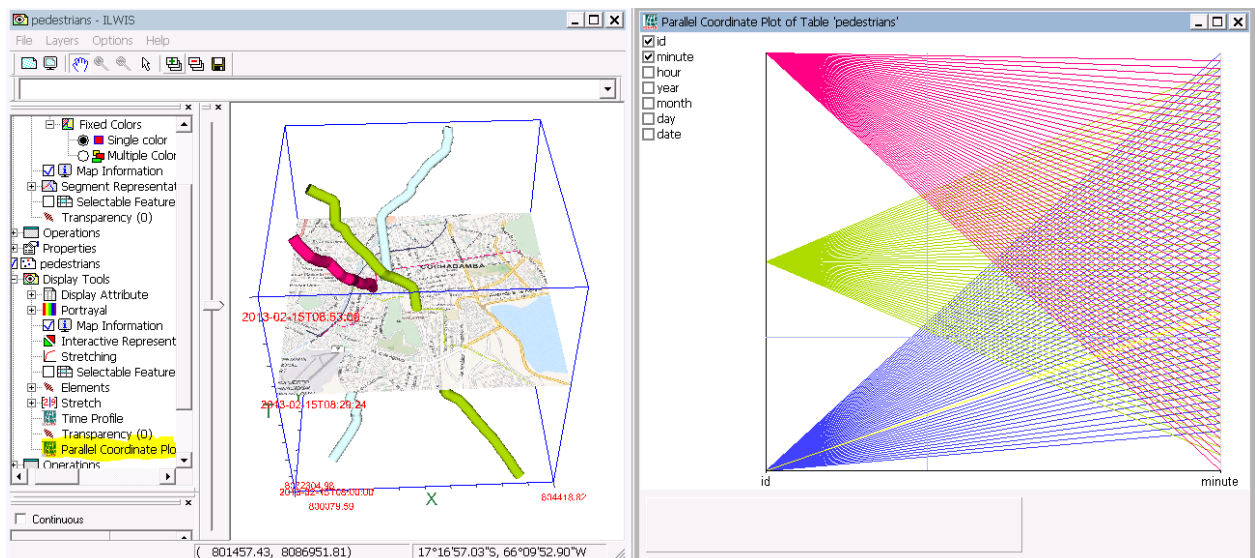

The Parallel Coordinate Plot is available for any layer that has an attribute table (thus not only for Point Maps with a temporal attribute).

EXAMPLE

Consider the Point Map “pedestrians” that has the trajectories of three pedestrians in the city-center of Cochabamba, Bolivia.

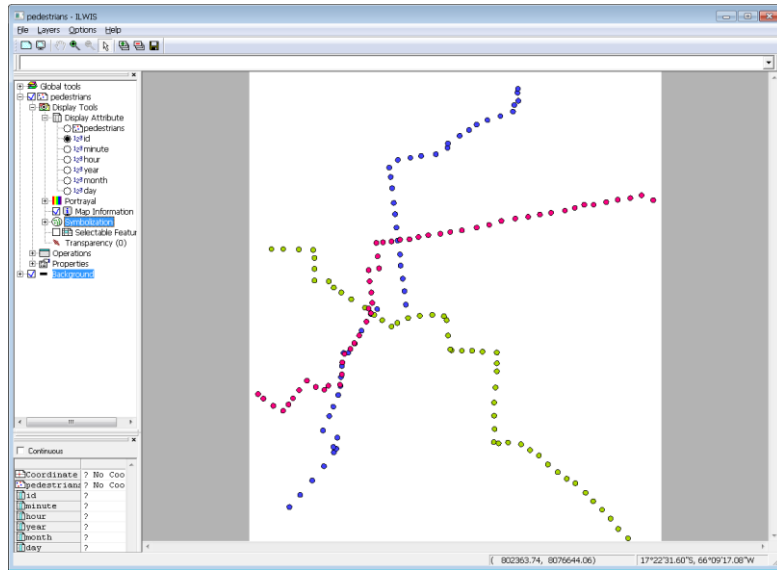

The available attributes are the pedestrian's identifier (1, 2 or 3), the year (2013), month (2nd month: February), day (15th), hour (8am) and minute of the day:

	id	year	month	day	hour	minute
pnt 40	1	2013	2	15	8	44
pnt 41	1	2013	2	15	8	45
pnt 42	1	2013	2	15	8	46
pnt 43	1	2013	2	15	8	47
pnt 44	1	2013	2	15	8	48
pnt 45	1	2013	2	15	8	49
pnt 46	1	2013	2	15	8	50
pnt 47	1	2013	2	15	8	51
pnt 48	1	2013	2	15	8	52
pnt 49	1	2013	2	15	8	53
pnt 50	2	2013	2	15	8	2
pnt 51	2	2013	2	15	8	3
pnt 52	2	2013	2	15	8	4
pnt 53	2	2013	2	15	8	5
pnt 54	2	2013	2	15	8	6
pnt 55	2	2013	2	15	8	7
pnt 56	2	2013	2	15	8	8
pnt 57	2	2013	2	15	8	9

All existing attributes in this table are of type "integer" (in ILWIS terms they are of domain "value" with a precision of 1.0), thus there is no attribute of domain "time". We will use the application "Columns to Time Column" in the Table window's menu to make one.

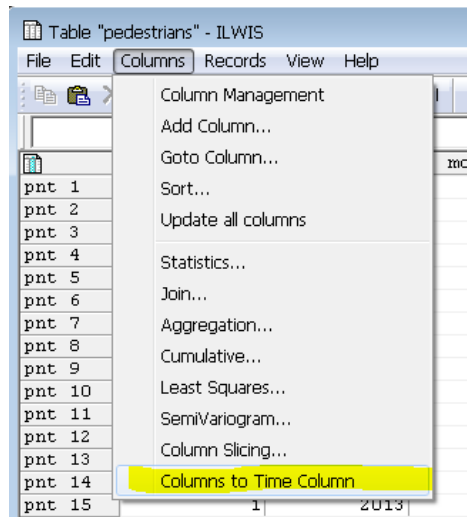

In the “Create time column” form that appears, the correct attributes from the table must be matched to the year, month, day, hours and minutes components of the new attribute. There is no attribute to match “seconds”, therefore it is left unselected (the “seconds” component of the time-data will be set to 0). Also a name must be entered in the Output Column. Note that the name “time” is reserved, and therefore it is not allowed as a name for the new attribute. Note also that the application allows for a String attribute (e.g. “2012-06-17 08:23:44”) to be parsed into time.

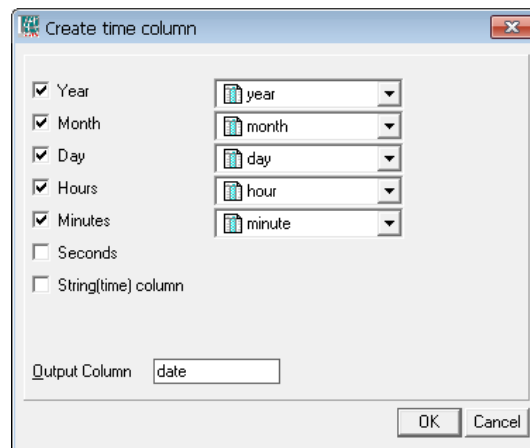

The resulting attribute appears is added to the right of the table:

	id	year	month	day	hour	minute	date
pnt 40	1	2013	2	15	8	44	2013-02-15T08:44:00
pnt 41	1	2013	2	15	8	45	2013-02-15T08:45:00
pnt 42	1	2013	2	15	8	46	2013-02-15T08:46:00
pnt 43	1	2013	2	15	8	47	2013-02-15T08:47:00
pnt 44	1	2013	2	15	8	48	2013-02-15T08:48:00
pnt 45	1	2013	2	15	8	49	2013-02-15T08:49:00
pnt 46	1	2013	2	15	8	50	2013-02-15T08:50:00
pnt 47	1	2013	2	15	8	51	2013-02-15T08:51:00
pnt 48	1	2013	2	15	8	52	2013-02-15T08:52:00
pnt 49	1	2013	2	15	8	53	2013-02-15T08:53:00
pnt 50	2	2013	2	15	8	2	2013-02-15T08:02:00
pnt 51	2	2013	2	15	8	3	2013-02-15T08:03:00
pnt 52	2	2013	2	15	8	4	2013-02-15T08:04:00
pnt 53	2	2013	2	15	8	5	2013-02-15T08:05:00
pnt 54	2	2013	2	15	8	6	2013-02-15T08:06:00
pnt 55	2	2013	2	15	8	7	2013-02-15T08:07:00
pnt 56	2	2013	2	15	8	8	2013-02-15T08:08:00
pnt 57	2	2013	2	15	8	9	2013-02-15T08:09:00

To visualize the Point Map “pedestrians” in the Space Time Cube, double-click it to open it in a Map Window. Then in the layer manager on the left of the Map Window, enable “3D” and enable “Space Time Cube”. The result will look like this:

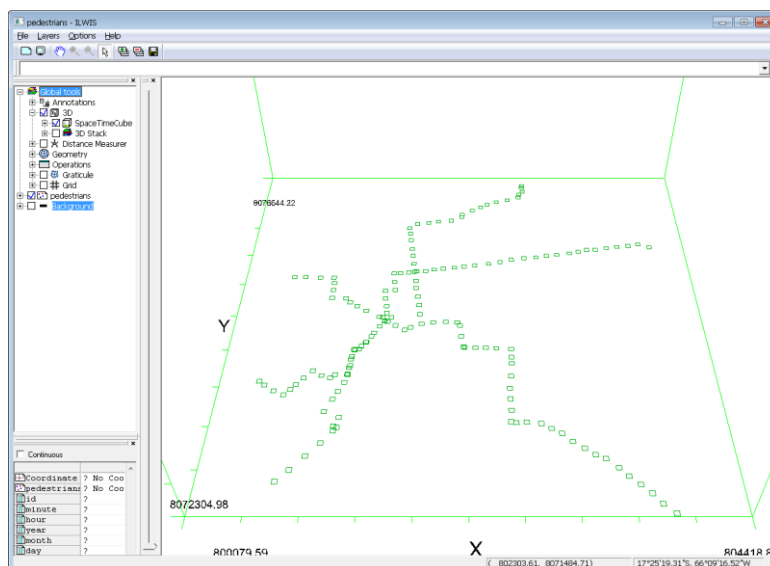

Using the layer manager, add the polygon map “cityblock” and the base map “openstreetmap”. Then double-click Space Time Cube tool in the layer manager, and in the “Select Layer Options” form that appears, change the options as follows (change <regular> to <stp> and set “group by” to “id”):

Click Apply to let the changes take effect, then click Close to close the form.

To change the colors of the three pedestrians, to let each pedestrian have its own color, open the Display Options of layer “pedestrians” in the layer manager, and change the “Display Attribute” to “id”. This will use colors from the so-called PSEUDO representation, which is the default color-ramp for values, and apply them to the pedestrians (id=1 becomes blue, id=2 becomes green, id=3 becomes red). Use the vertical scrollbar to position the background layers to 8:30AM. The result will look like this:

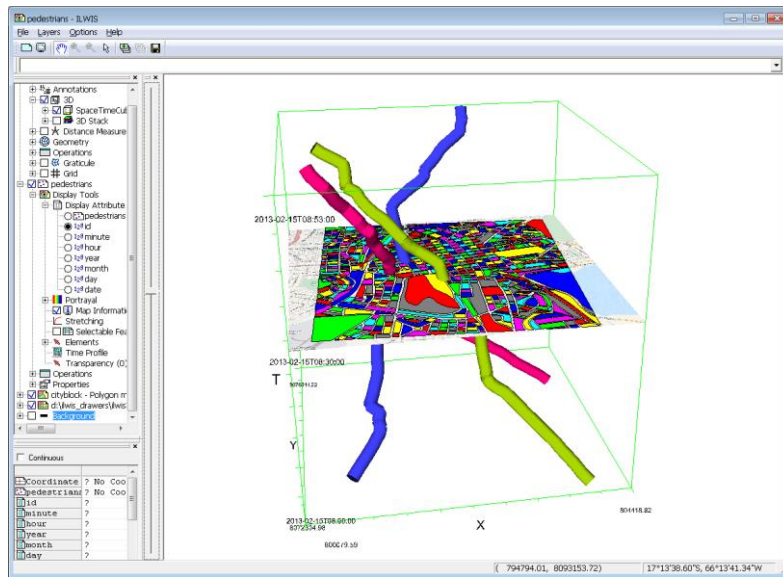

To rotate/move/zoom the cube/3D space of the Map Window, press Ctrl and drag the mouse using the left button (rotate), right-button (translate/move), middle-button (zoom). When not pressing Ctrl, the default mouse function is to identify the object(s) at the mouse-pointer by showing the selected Display Attribute. Alternatively, the “Pan” mode can be entered, by pressing the “Pan” button (the hand at the toolbar of the Map Window). This will change the mouse function to rotate/move/zoom, without requiring the Ctrl button to be pressed. To change the mouse function back to normal mode (identify), press the “Arrow” button on the toolbar.

The attributes of all layers (visibility, transparency, coloring, size etc.), including those of the spatiotemporal layers, can be changed as usual. Specifically for each Space Time Path, the Stretching controls its size, and under “Elements” the number of edges of the cylinders can be changed and the Footprint can be displayed. Here the footprint of the three pedestrians can be seen, as thin colored lines on the floor of the cube.

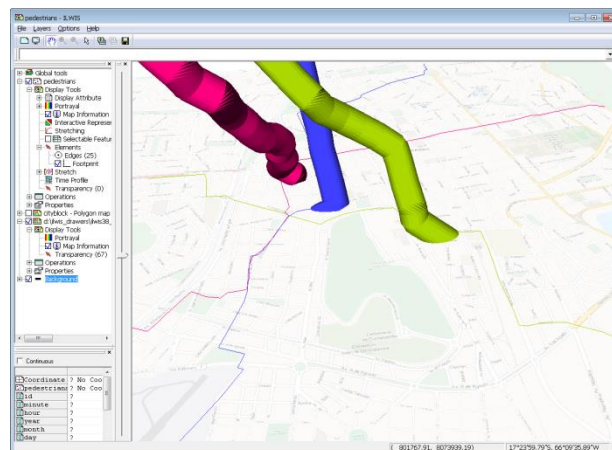

ADDENDA

MAKING HATCHING PATTERNS

The hatching patterns used by Ilwis are defined in a number of text files (one for each pattern) located in { installation folder}\Resources\Symbols. In this folder you will find a set of files with the .ivh extension. These files are xml files containing a header line and 32 lines containing strings with '0's and '1's (also 32). The '0' marks a transparent area, the '1' marks an opaque area. The files **must** always contain this pattern of 32 lines with lines with 32 characters ('0', '1'). The name of the file (without extension) is the name as it appears in the user interface. One can add or remove hatchings as one sees fit. Remember though that, if you want to exchange files with others, the hatching have to be present at both systems.

MAKING SYMBOLS

The symbols of point maps are defined in text files (xml) located in { installation folder}\Resources\Symbols. In this folder you will find a number of files with the .ivg extension. These files contain the definition of the symbols.

The definition uses a small subset of SVG (http://en.wikipedia.org/wiki/Scalable_Vector_Graphics) to define the symbols. The elements of SVG that are supported are:

Element	Property	Values	Description
Line	Coordinates	x1,x2,y1,y2	Note that range of the numbers doesn't matter. Ilwis will scale the symbol into a default size irrespective of the numbers. The coordinates define the positions relative to themselves, not in the absolute system. Within one ivg file though, the coordinates must be consistent.
	Style description	String	A string with a style definition. The elements in this string may occur as concatenated style description or as separate distinct elements. It is a colon separated list
	stroke	Color	follows the normal svg conventions with one exception and that is the color 'user-defined' is allowed. This color comes than from Ilwis (e.g. representation) and not from the ivg file
	Stroke-width	number	Number
Circle	Style description		See 'Line'
	Stroke		See 'Line', circumference of the circle
	Stroke-width		See 'Line', circumference of the circle
	r	Number	Radius of the circle. Same remark as for coordinates applies here.
	Fill	Color	Fill color, for the rest same as 'Stroke'.

Rect	Style description		See 'Line'
	Stroke		See 'Line', boundary
	Stroke-width		See 'Line', boundary
	Width	Number	It may contain the value 'user-defined' in which case it always extends to the whole width of the symbol
	Height	Number	It may contain the value 'user-defined' in which case it always extends to the whole height of the symbol
	Fill		Same as 'Circle'
Polygon	Style description		See 'Line'
	Stroke		See 'Line', boundary
	Stroke-width		See 'Line', boundary
	points	Coordinate pairs	A space separated list with pairs of coordinate describing the geometry. The x,y's are using ',' as separator. The first and last coordinates must be the same.
	Fill		Same as 'Circle'
Path			<p>Path is the most complicated of the supported elements. It contains a definition string ("d") which describes the path that should be drawn. The path can contain lines, curves and gaps. The description below is about the elements in the definition string</p> <p>Often there are two variants. One with capital, one with lower case. The one with capital uses absolute positioning, the one with lower case relative positioning with respect to the current pen location</p>
	M, m	X,y	Moves pen to specified point x,y without drawing.
	L,l	X,y	Draws a line from current pen location to specified point x,y .
	H,h	x	Draws a horizontal line to the point defined by 'x' and the pens current 'y'
	V,v		Draws a vertical line to the point defined by 'y' and the pens current 'x'
	C,c	x1,y1 x2,y2 x,y	Draws a cubic Bezier curve from current pen point to x,y. x1,y1 and x2,y2 are start and end control points of the curve, controlling how it bends.
	S,s	x2,y2 x,y	Draws a cubic Bezier curve from current pen point to x,y. x2,y2 is the end control point. The start control point is assumed to be the same as the end control point of the previous curve.
	Q,q	x1,y1 x,y	Draws a quadratic Bezier curve from current pen point

		to x,y. x1,y1 is the control point controlling how the curve bends.
A,a	elliptical arch: X,Y rx ry	<p>Draws an elliptical arch from the current point to the point x,y. rx and ry are the elliptical radius in x and y direction.</p> <p>The x-rotation determines how much the arch is to be rotated around the x-axis. It only seems to have an effect when rx and ry have different values.</p> <p>The large-arch-flag doesn't seem to be used (can be either 0 or 1). Neither value (0 or 1) changes the arch.</p> <p>The sweep-flag determines the direction to draw the arch in.</p>
T,t	X,y	Draws a quadratic Bezier curve from current pen point to x,y. The control point is assumed to be the same as the last control point used.
Z		Closes the path by drawing a line from current point to first point.

Multiple elements can be used in an svg file to draw the shape you want.

Below is the simple drawing of a flag, combining polygon and line

```
<polygon points="0,0 50,0 45,20 50,40 0,40 0,0" style="fill:user-defined;stroke-width:1;stroke:black"/>
<line x1="0" y1="0" x2="0" y2="70" style="stroke-width:2;stroke:black"/>
```

The symbol will use the file name as name in the user interface (without extension).

MAKING ID COLOR SCHEMES

Domain ID and uniqueid can use a number of color schemes to visualize their elements (see also '[FIXED COLORS](#)'). These schemes are described in .ics files that are located in in { installation folder }\system. The files contain 33 lines. One line with an index number and 32 lines with color definitions. The indexes of the files must always be consecutive from 0 to N. There must always be one file marked as default. This file is the default choice of the system.

The color definitions have special ordering. In these schemes you have the option of 8, 16 or 32 colors. The first 8 entries are the color of the '8' definition. The next 8 are the colors in between the first 8 (making 16 colors in total). The next 16 are again in between the previous group.